

Catálogo de **BRINDES** PERSONALIZADOS



Sillo
Promocional



Siga no
Instagram



@sillopromocional



Curta nossa
Fan Page



@sillopromocional



Fale com um
Especialista



11 4608-0318

Visite nosso site



sillopromocional.com.br

Índice



20 – 25 | 108 – 111 | 160 – 165



60 – 69

06



19

Escritório

59

Tecnologia

107

Escrita

159

Mochilas, Malas
& Pastas

203

Pessoal & Viagem

229

Chaveiros
& Lanternas

247

Casa,
Restaurante & Bar

289

Sacolas &
Bolsas Térmicas

317

Squeezes, Copos
& Esporte

369

Criança
& Escolar

383

Sol & Chuva

Serviços de personalização de qualidade



COMO LER AS NOSSAS DESCRIÇÕES

Nome — Referência do artigo

Descrição do produto.

Dimensões do produto

41 x 60 x 23 mm

Técnica recomendada + dimensão máxima

PDP - 20 x 10 mm

 Sem Personalização

 Personalização Sob Consulta



UVC

UV CIRCULAR



Impressão UV digital aplicada a objetos cilíndricos em toda a sua circunferência.

Materiais recomendados



Vidro



PU



Metal



Silicone



Papel



Madeira



PP; ABS; PVC; Acrílico



DTT

TRANSFER DIGITAL

A impressão da personalização é feita diretamente de uma impressora para o papel, que posteriormente é aplicada por meio de pressão e calor. Permite impressão a full color.

Materiais recomendados



Cortiça



PU



C. sintético



Couro reciclado



Papel



Tecido

STI

ETIQUETAS

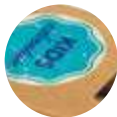

Impressão de etiquetas em vinil com qualidade fotográfica e grande variedade de tamanhos e formas.

Materiais recomendados

- Vidro
- Metal
- Papel
- PP; ABS; PVC; Acrílico

DGL

IMPRESSÃO DIGITAL



A impressão digital consiste em imprimir papel, com qualidade fotográfica.

Materiais recomendados

- Papel

SUB

SUBLIMAÇÃO



Impressão em papel da personalização por uma impressora que utilize tintas de sublimação. A transferência da tinta para o produto é feita através de pressão e calor.

Materiais recomendados

- Metal
- Cerâmica; Porcelana

LAS

LASER CIRCULAR



Utilização de um raio laser de grande precisão otimizado para aplicação em superfícies curvas.

Materiais recomendados

- Cortiça
- Metal
- Madeira

HTS

HOT STAMPING



Reprodução de personalizações através de uma prensa quente em produtos de couro ou imitação de couro. Pode ser ainda aplicada uma cor metalizada (dourado ou prateado) no molde.

Materiais recomendados

- C. sintético
- Pele

DUV

UV DIGITAL



Impressão da personalização numa máquina semelhante a uma impressora de cartucho em materiais. A secagem é feita através de luz ultravioleta.

Materiais recomendados

- Vidro
- Metal
- Papel
- PP; ABS; PVC; Acrílico
- PU
- Silicone
- Madeira

LSR

LASER



Utilização de um raio laser de grande precisão, permitindo uma gravação em baixo-relevo. Este laser pode ser de fibra ótica, adequado para metais, ou de CO2, adequado para madeiras ou cortiça.

Materiais recomendados

- Cortiça
- Metal
- Madeira

TRS

TRANSFER



Impressão da personalização através de uma tela para um papel, que será depois aplicada no produto por meio de pressão e calor. Recomendada para produtos não planos, como mochilas.

Materiais recomendados

- Cortiça
- C. sintético
- Papel
- PU
- Couro reciclado
- Tecido

SCR

SILK SCREEN



Impressão da personalização num fotolito, que é passada para uma tela de fios através de luz ultravioleta. A tinta é aplicada através de um rodo e posterior secagem.

Materiais recomendados

- Cortiça
- Vidro
- C. sintético
- Metal
- PP; ABS; PVC; Acrílico
- Papel
- Couro reciclado
- Silicone
- Madeira

SRC

SILK SCREEN CIRCULAR



Processo idêntico ao da silk screen mas direcionado para impressão em produtos circulares.

Materiais recomendados

- Cortiça
- Vidro
- C. sintético
- Metal
- PP; ABS; PVC; Acrílico
- Papel
- Couro reciclado
- Silicone
- Madeira

PDP

TAMPOGRAFIA



Técnica ideal para pequenos objetos e formas curvilíneas, a transferência de tinta é feita através de um tampão de silicone que se adapta aos mesmos.

Materiais recomendados

- Cortiça
- Vidro
- Metal
- PU
- PP; ABS; PVC; Acrílico
- Papel
- Silicone
- Madeira

TXP

SILK SCREEN TÊXTIL



Processo idêntico ao da silk screen, mas direcionado para impressão em produtos têxteis de grandes formatos.

Materiais recomendados

- Cortiça
- C. sintético
- Papel
- PU
- Couro reciclado
- Tecido

Suco[®]

BRAZIL

ESSÊNCIA COLORIDA





**Repita encomendas,
receba os mesmos tamanhos**

Padronização de medidas



**Repita encomendas,
receba as mesmas cores**

Padronização de cores



**Nunca perca uma
encomenda**

Pronta entrega



Poupe tempo e dinheiro

Frete grátis



Encomende quanto quiser

Sem quantidade mínima

**22 cores
4 modelos**

Já pode garantir
a mesma **qualidade**,
quantidade e **produto**
para seus clientes
de uma encomenda
para outra!

**CAMISETAS
100% ALGODÃO!**



ESSÊNCIA COLORIDA

Encontre sua Essência.

Um dia você percebe que hoje é como ontem,
Ontem foi igual a antes de ontem e há um mês já era assim...
Sem saber como, a vida deixou de ter cor.
O cinza passou a ser normal e o igual já não faz mais diferença.
Mas preto e branco não é para você!

Ser SUCO® é ser fresco e ter cor sem fim.

A doçura da fruta madura acabada de colher.

É apaixonar-se constantemente, por tudo e por nada.

E ter sabor, muito sabor!

É a energia de um arco íris.

Um samba o dia todo que não para de tocar.

A substância pura em tudo o que se faz.

É ter a complexidade do mais simples em você

e voltar à Essência, sempre!



SUTCO

Papaya



Papaya

Camiseta unissex de corte regular em malha 100% algodão (165 g/m²) com fio 30/1 misto. Com gola em ribana 1,5x1,5 com fita de reforço e com costura dupla nas mangas, barra de fundo e laterais.

Tamanhos: P, M, G, GG
TXP - 280 x 200 mm



Papaya Women

Camiseta feminina de corte cinturado em malha 100% algodão (165 g/m²) com fio 30/1 misto. Com gola em ribana 1x1 com fita de reforço e com costura dupla nas mangas, barra de fundo e laterais.

Tamanhos: P, M, G, GG
TXP - 240 x 200 mm

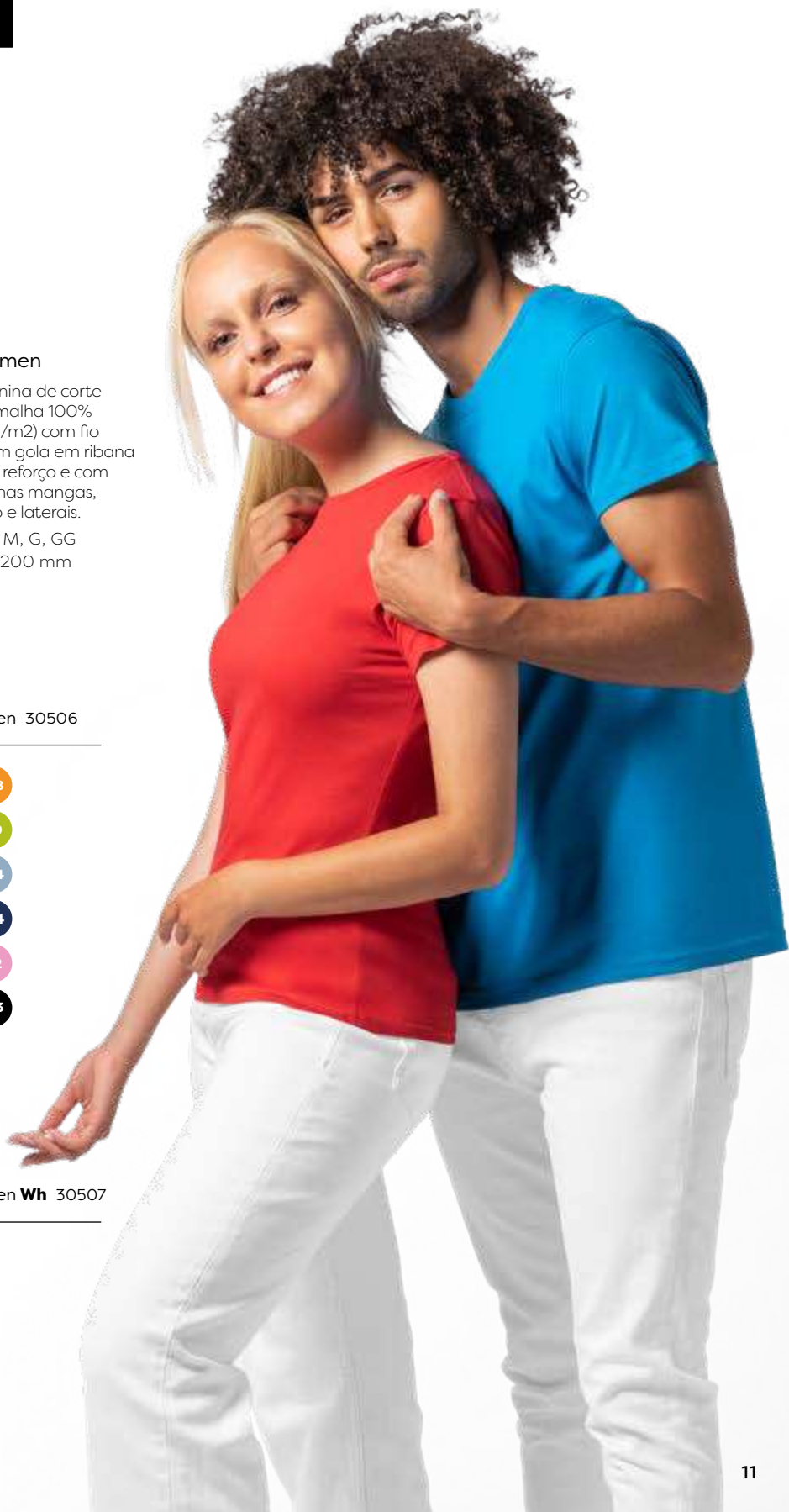

Papaya 30504

- 154
- 114
- 104
- 132
- 168
- 112
- 102
- 105
- 115
- 128
- 108
- 148
- 119
- 109
- 149
- 164
- 113
- 103
- 183
- 196



Papaya Wh 30505

- 106



Papaya Women 30506

- 105
- 115
- 128
- 108
- 148
- 119
- 109
- 149
- 164
- 154
- 114
- 104
- 132
- 168
- 112
- 102
- 113
- 103
- 183



Papaya Women Wh 30507

- 106



Pitanga



Pitanga

Camiseta unissex de corte regular em malha 100% algodão (170 g/m²) com fio 30/1 penteado. Com gola em ribana 1,5x1,5 com fita de reforço e com costura dupla nas mangas, barra de fundo e laterais.

📏 **Tamanhos:** P, M, G, GG
 📏 **TXP** - 280 x 200 mm



Pitanga Women

Camiseta feminina de corte cinturado em malha 100% algodão (170 g/m²) com fio 30/1 penteado. Com gola em ribana 1x1 com fita de reforço e com costura dupla nas mangas, barra de fundo e laterais.

📏 **Tamanhos:** P, M, G, GG
 📏 **TXP** - 240 x 200 mm



Pitanga 30500



Pitanga Wh 30501



Pitanga Women 30502



Pitanga Women Wh 30503





Goiaba



Goiaba

Camiseta unissex de corte regular em malha 100% algodão (135 g/m²) com fio 30/1 misto. Com gola em ribana 1,5x1,5 com fita de reforço e com costura dupla nas mangas, barra de fundo e laterais.

Tamanhos: P, M, G, GG
TXP - 280 x 200 mm



Goiaba Women

Camiseta feminina de corte cinturado em malha 100% algodão (135 g/m²) com fio 30/1 misto. Com gola em ribana 1x1 com fita de reforço e com costura dupla nas mangas, barra de fundo e laterais.

Tamanhos: P, M, G, GG
TXP - 240 x 200 mm



Goiaba 30508



Goiaba Women 30510



Goiaba Wh 30509



Goiaba Women Wh 30511





Amora



Amora

Camiseta unissex de corte regular em malha 100% polyester fiado (135 g/m²) com fio 30/1 polyester. Com gola em ribana 1,5x1,5 com fita de reforço e com costura dupla nas mangas, barra de fundo e laterais.

Tamanhos: P, M, G, GG
TXP - 290 x 200 mm



Amora Women

Camiseta feminina de corte cinturado em malha 100% polyester fiado (135 g/m²) com fio 30/1 polyester. Com gola em ribana 1x1 com fita de reforço e com costura dupla nas mangas, barra de fundo e laterais.

Tamanhos: P, M, G, GG
TXP - 240 x 200 mm



Amora 30512



Amora Wh 30513



Amora Women 30514



Amora Women Wh 30515





Escritório



BRANVE®

O magnetismo das personalidades fortes e a capacidade de combinar consigo. De design cosmopolita e carácter vincado, a BRANVE® é contemporaneidade e inovação. Conforto, durabilidade e elegância aliadas à praticidade – para quem procura o luxo da funcionalidade em cada detalhe.

THE BRAND THAT MATCHES

Saiba mais online

branve.com

Encontre outros produtos BRANVE®

 .108 Escrita

 .160 Mochilas, Malas & Pastas



DYNAMIC COLLECTION

Para os dinâmicos
com mais estilo

Encontre mais produtos DYNAMIC

 .161



2 blocos em 1

Faixa personalizável





104

 **Dynamic Notebook**
93597



O DYNAMIC é um caderno A5 idealizado e desenhado para ser um objeto funcional e prático com um toque de elegância citadina. Possui dois blocos de escrita diferentes, em cada um dos lados, que podem ser utilizados e fechados, separadamente. Possui sistema de fecho com ímã na faixa que envolve o bloco. A faixa, tem uma cor diferente em cada um dos lados, permitindo a sua identificação, conferindo uma certa irreverência ao produto. O material exterior é em polípele de elevada qualidade e 1680D, texturado e plano. Possui 128 folhas que se dividem proporcionalmente em folhas não pautadas e folhas pautadas, identificáveis pela faixa exterior. O DYNAMIC torna-se único pelo seu design mas também pela sua funcionalidade, em que a dualidade o torna num objeto perfeito para todos os momentos do dia-a-dia. Fornecido em caixa presente.

 150 x 210 mm | Caixa: 200 x 30 x 265 mm

 HTS - 35 x 10 mm

EMPIRE COLLECTION

Exclusiva para personalidades sofisticadas

Encontre mais produtos EMPIRE

 .163



103

A5 Empire Notebook 93598

O EMPIRE é um caderno A5 de design moderno, minimalista e com toque business. A capa dura em couro protege o seu interior que, de forma inteligente, se divide em três partes distintas com um separador que permite identificar cada uma das partes. As suas 120 folhas dividem-se proporcionalmente por folhas não pautadas, pautadas e pontilhadas. O seu design minimalista é complementado pelo detalhe metálico no fecho, característico desta linha de produtos e que reforça a sua elegância. Produto fornecido com suporte de esferográfica (não inclusa). Fornecido em caixa presente.

150 x 210 mm | Caixa: 197 x 28 x 262 mm

LSR - 15 x 15 mm



Fecho metálico personalizável

3 tipos de páginas

INKUOTE COLLECTION

Para aqueles que não dispensam escrever em papel

Encontre mais produtos INKUOTE

 .108



103



Geometric Notebook
93596



O GEOMETRIC é um caderno A5 com capa dura em c. sintético e com 128 folhas pautadas. O design de sua capa foi inspirado em figuras geométricas baseadas em padrões de ilusão ótica. A banda elástica, que permite fechar o caderno, o marcador de livros e o suporte de esferográfica (não inclusa) reforçam a utilidade deste caderno. Mais do que um caderno, é um suporte para comunicação de emoções. Algo muito pessoal e único. Fornecida em caixa presente.

140 x 210 mm | Caixa: 175 x 25 x 265 mm

HTS - 40 x 30 mm

**INKUOTE
COLLECTION**



103

**A5 Tiles Notebook
93737**

O TILES é um caderno A5 com capa dura em c.sintético com 128 folhas pautadas no seu interior. Todo este bloco foi idealizado com base em elementos culturais, neste caso concreto os azulejos portugueses. A banda elástica que permite fechar o caderno, o marcador de livros e o suporte de esferográfica (não inclusa), reforçam a utilidade deste caderno. Mais do que um caderno, é um suporte para comunicação de emoções. Algo muito pessoal e único. Fornecido em caixa presente.

140 x 210 mm | Caixa: 175 x 25 x 265 mm

HTS – 85 x 30 mm





Papel proveniente de uma gestão florestal sustentável

Fibra de palha

Uma combinação que respeita o meio ambiente e reforça o compromisso com a sustentabilidade.

160



Placa em metal para personalização a laser

A

A



ECÓlogic

Neruda — 93275

A5



Caderno A5 com capa dura em palha natural. Incluso uma placa em metal, própria para personalização, para adicionar à capa. Contém 96 folhas pautadas em papel cor marfim proveniente de gestão florestal sustentável. Fornecido em envelope de cartão.

150 x 210 mm | Placa: 30 x 15 mm

LSR – 25 x 10 mm

104

103



Combinação de materiais: palha e algodão



ECÓlogic

Rousseau — 93268

A5



Caderno A5 com capa dura em palha e algodão canvas. Contém 96 folhas pautadas, fita separadora, elástico e suporte para esferográfica (não inclusa).

150 x 210 mm

TRS – 100 x 110 mm



Papel proveniente de uma gestão florestal sustentável

Com bolso interior

111

Pele reciclada

A pele reciclada pode ser feita a partir de móveis, roupa ou sapatos usados, bem como de sobras de pele de outros produtos.



103

111



NEW

EcoLogic



Matisse — 93087



Caderno A5 em couro reciclado com 96 folhas pautadas cor marfim, em papel proveniente de gestão florestal sustentável. Suporte para esferográfica (não incluída), elástico e fita separadora em preto. Contém bolso interior. Fornecido em envelope preto de cartão.



140 x 210 mm

TR5 - 85 x 120 mm





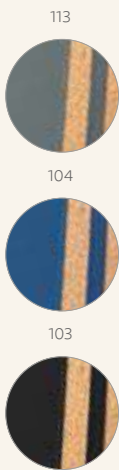

113



ECÓlogic

 **Tordo** — 93593

 Caderno A5 com capa dura em cortiça e PU e 96 folhas pautadas em cor marfim. Contém elástico, fita separadora e suporte para esferográfica (não inclusa). Fornecido em bolsa de non-woven.

↕ 140 x 210 mm

↗ HTS – 70 x 60 mm



160



ECÓlogic

 **Portel A5** — 93730

 Caderno A5 com capa dura em cortiça, 80 folhas não pautadas em cor marfim, fita separadora, elástico e suporte para esferográfica (não inclusa). Fornecido em bolsa de non-woven.

↕ 137 x 215 mm |

Embalagem: 185 x 240 mm

↗ TRS – 100 x 180 mm



ECÓlogic

 **Portel A6** — 93731

 Caderno A6 com capa dura em cortiça, 80 folhas não pautadas em cor marfim, fita separadora, elástico e suporte para esferográfica (não inclusa). Fornecido em bolsa de non-woven.

↕ 97 x 145 mm |

Embalagem: 133 x 170 mm

↗ TRS – 75 x 120 mm



160

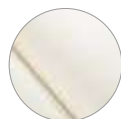

ECÓlogic

 **Almodovar** — 93489

 Caderno A5 em cortiça com capa dura e 80 folhas não pautadas em cor marfim.

↕ 127 x 180 mm

↗ TRS – 80 x 120 mm



160

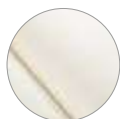

ECÓlogic

 **Adams A5** — 93719

 Caderno capa dura A5 em cortiça com 80 folhas não pautadas em cor marfim e fita separadora.

↕ 140 x 210 mm

↗ TRS – 110 x 180 mm



160



ECÓlogic

 **Adams A6** — 93720

 Caderno capa dura A6 em cortiça com 80 folhas não pautadas em cor marfim e fita separadora.

↕ 90 x 142 mm

↗ TRS – 60 x 90 mm



Cortiça

A combinação de materiais naturais permite criar blocos únicos e sustentáveis.



Papel proveniente de uma gestão florestal sustentável



NEW

ECOlogic



Freud — 93578



Conjunto de bloco de notas A5 e esferográfica em cortiça. Bloco com 96 folhas com linhas pautadas cor marfim, em papel proveniente de gestão florestal sustentável. Esferográfica de escrita a azul. Fornecido em caixa presente de papel craft.



140 x 210 mm

SCR - 150 x 150 mm



Tratamento antibacteriano

Para um ambiente de trabalho mais seguro.



NEW

 **Coben** — 93474

 Caderno A5 em PP com tratamento antibacteriano, segundo a certificação ISO22196. Contém 80 folhas pautadas em papel reciclado branco.

 140 x 213 mm

 SCR – 90 x 180 mm



rPET + Tratamento Antibacteriano



Papel proveniente de uma gestão florestal sustentável



123

A

Tratamento antibacteriano

A



Mondrian — 93577

Caderno A5 em PET reciclado com tratamento antibacteriano, segundo a certificação ISO 20743. Contém 80 folhas pautadas cor marfim, em papel proveniente de gestão florestal sustentável, elástico e fita separadora.

140 x 210 mm

TR5 – 90 x 150 mm



Papel proveniente de uma gestão florestal sustentável

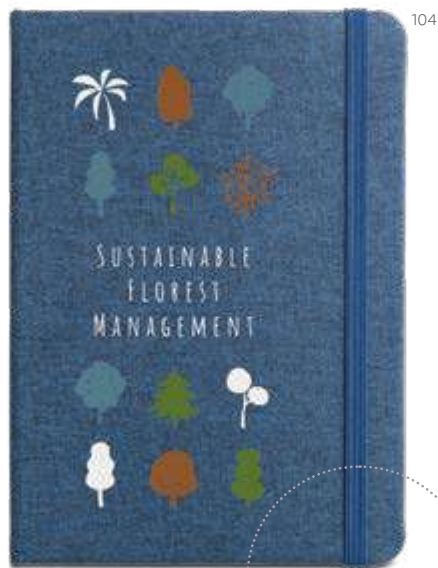

104

Produzido a partir de plástico reciclado



Boyd — 93276

Caderno A5 com capa dura em rPET. Contém 96 folhas pautadas em papel cor marfim proveniente de gestão florestal sustentável, fita separadora, elástico e bolso em papel na parte traseira da capa.

140 x 210 mm

TR5 – 80 x 120 mm



104

105

133



Linho

O linho é um dos tecidos mais ecológicos que existe, para além disso suas fibras são duráveis e fortes.



ECÓlogic



Nerval — 93270



Caderno com capa dura em linho (230 g/m²). Cantos redondos e 96 folhas pautadas. Esferográfica não inclusa.



140 x 210 mm

TR5 — 110 x 180 mm

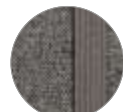
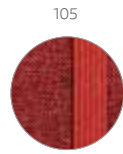

A5 Hugo — 93591

Caderno A5 com capa dura forrada em tecido poliéster e 80 folhas pautadas em cor marfim. Contém elástico e fita separadora.

137 x 210 mm

TR5 — 90 x 180 mm

Tecido tipo jeans

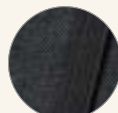
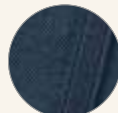
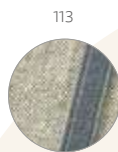

A5 Denim — 93594

Caderno A5 com capa dura forrada em tecido tipo jeans e 96 folhas pautadas. Contém elástico, fita separadora, bolso interior e suporte para esferográfica (não inclusa).

140 x 210 mm

TR5 — 90 x 180 mm

A5 Carrey — 93725

Caderno A5 em canvas (poliéster) com capa dura. Contém 96 folhas não pautadas em cor marfim, fita separadora, elástico e suporte para esferográfica (não inclusa). Fornecido em bolsa de non-woven.

148 x 210 mm | Bolsa: 185 x 240 mm

TR5 — 95 x 140 mm



123



NEW

A5 Moraes — 93714

Conjunto esferográfica e caderno A5. A esferográfica é em alumínio com clipe de ferro e é de mecanismo twist com escrita a azul. O caderno A5 tem capa rígida, fita separadora, elástico, bolso interior e 80 folhas pautadas de cor marfim. Conjunto fornecido em caixa de oferta.

Esferográfica: Ø10 x 138 mm |
Caderno: 137 x 210 mm | Caixa: 190 x 240 x 30 mm

SCR – 100 x 190 mm



103

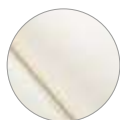

A5 Gullar — 93499

Kit de caderno A5 e esferográfica em cartão e alumínio. Caderno capa dura com 96 folhas não pautadas de cor marfim. Esferográfica de escrita a preto. Fornecidos em caixa almofadada.

Caderno: 137 x 210 mm |
Esferográfica: Ø11 x 136 mm | Caixa: 190 x 240 x 30 mm

SCR – 150 x 190 mm



103



A5 Chaucer — 93497

Caderno A5 em c. sintético com capa dura e 96 folhas não pautadas. Incluso fita separadora, elástico e suporte para esferográfica. Incluso esferográfica de metal. Fornecida com caixa presente.

139 x 216 mm | Caixa: 145 x 220 x 15 mm

SCR – 70 x 150 mm

Capas multifunções perfeitas para uma boa organização



A5 **Pessoa** — 93734

Capa em tecido em poliéster, com caderno A5 removível com 80 folhas não pautadas. Com bolso interior e suporte para esferográfica (não inclusa). Fornecida em embalagem de non-woven.

160 x 220 mm | Bolsa: 205 x 250 mm

TRS – 80 x 60 mm

• Fecho magnético



• Fecho magnético

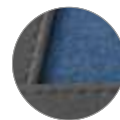

A5 **Lispector** — 93724

Caderno A5 em c. sintético, com capa dura e fecho magnético. Contém suporte para esferográfica (não inclusa), 96 folhas não pautadas cor marfim e fita separadora. Fornecido em bolsa de non-woven.

148 x 210 mm | Bolsa: 185 x 240 mm

TRS – 70 x 180 mm

A5 **Russel** — 93788

Capa em c. sintético e tecido em poliéster com caderno A5 removível com 80 folhas não pautadas. Contém fecho magnético, bolso exterior, bolso interior e suporte para esferográfica (não inclusa). Fornecida em embalagem de non-woven.

155 x 215 mm | Bolsa: 205 x 250 mm

TRS – 140 x 170 mm



A5 Moriah — 93799

Caderno A5 com capa dura em c. sintético e 96 folhas pautadas. Suporte para esferográfica (não inclusa).

140 x 210 mm

HTS – 80 x 40 mm

A5 Kafka — 93712

Caderno A5 em c. sintético, capa dura e 80 folhas não pautadas. Contém elásticos com capacidade para suportar esferográfica (não inclusa), celular e cartões e um elástico para fechar o bloco de notas. Fornecido em bolsa de non-woven.

150 x 210 mm | Bolsa: 185 x 240 mm

SCR – 35 x 160 mm

Combine seu caderno de anotações A5 preferido com sua esferográfica de eleição e ofereça um presente totalmente exclusivo.

Exemplos:



Cadernos:

.26 à .39

Esferográficas:

.112 à .141

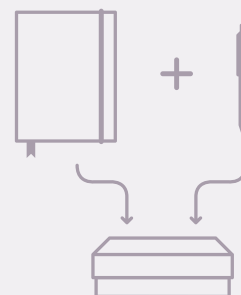

A5 Ozma — 91972

Caixa em cartão para 1 caderno A5 e 1 esferográfica com interior almofadado. Caderno e esferográfica não inclusos.

Caixa: 190 x 240 x 30 mm

SCR – 150 x 190 mm

Para que tenha sempre onde apontar

Dos blocos mais simples aos mais originais, é importante ter onde registrar as suas melhores ideias.



Com suporte para esferográfica



A5

Shakespeare — 93789

Caderno A5 com capa dura em c. sintético e 140 folhas não pautadas em cor marfim. Fornecido em bolsa de non-woven. Esferográfica não inclusa.

145 x 210 mm | Bolsa: 185 x 240 mm

SCR - 80 x 150 mm



Com suporte para esferográfica



A5

Shaw — 93795

Kit de caderno A5 e esferográfica em c. sintético com 80 folhas não pautadas, fita separadora e elástico. Esferográfica de escrita azul. Fornecido com caixa presente em PP com elástico.

Esferográfica: Ø10 x 137 mm | Bloco: 140 x 210 mm | Caixa: 155 x 214 x 13 mm

SCR - 100 x 180 mm

Cadernos com bolso interior e suporte para esferográfica



103



Carre — 93595



Caderno A5 com capa dura em c. sintético e 80 folhas pontilhadas em cor marfim. Contém elástico, fita separadora, bolso interior e suporte para esferográfica (não inclusa).

137 x 210 mm

DUV - 100 x 190 mm



106

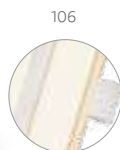

106



103



Chamberi A5 Ln — 93728



Caderno A5 com capa dura. Contém suporte para esferográfica, bolso interior e 80 folhas pautadas em cor marfim.

137 x 210 mm

SCR - 110 x 190 mm



114



114



123



Rodari — 93739



Caderno A5 com capa dura e 80 folhas não pautadas em cor marfim. Contém bolso interior e suporte para esferográfica (não inclusa).

137 x 210 mm

DUV - 100 x 180 mm



B

• **Efeito laser colorido**

Grave a laser e combine sua criatividade e combine sua criatividade com a cor do elástico! Combinações que valorizam sua marca!



B



105



A5 Roth — 93592

Caderno A5 com capa dura em PU térmico e 80 folhas pautadas. Contém elástico, fita separadora, bolso em papel na parte traseira da capa e suporte para esferográfica (não inclusa).

140 x 210 mm
LSR - 90 x 140 mm



123

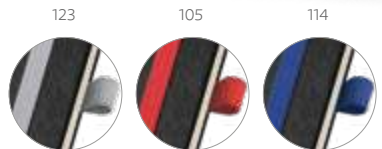

A5 Bouvier — 93729

Caderno A5 com capa dura. Contém suporte para esferográfica, bolso interior e 80 folhas pautadas em cor marfim.

137 x 210 mm
SCR - 120 x 190 mm



103

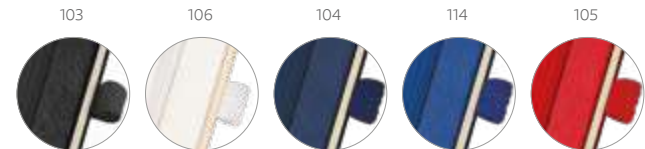

A5 Chamberi A5 — 93491

Caderno A5 com 80 folhas não pautadas em cor marfim e capa dura. Contém bolso interior, fita separadora, elástico e suporte para esferográfica (não inclusa).

137 x 210 mm
SCR - 100 x 190 mm

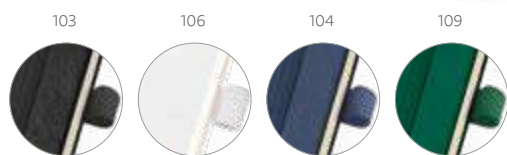
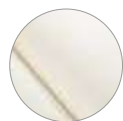

B6 Chamberi B6 — 93727

 Caderno B6 com capa dura. Contém suporte para esferográfica, bolso interior e 80 folhas não pautadas em cor marfim.

± 120 x 180 mm

✂ SCR – 100 x 160 mm



A6 Chamberi A6 — 93726

 Caderno A6 com capa dura. Contém suporte para esferográfica, bolso interior e 80 folhas não pautadas em cor marfim.

± 97 x 145 mm

✂ SCR – 70 x 130 mm



A5 Corbin — 93717

 Caderno A5 em c. sintético com capa dura. Contém 80 folhas pautadas, fita separadora, elástico e suporte para esferográfica (não inclusa).

± 140 x 210 mm

✂ SCR – 100 x 200 mm

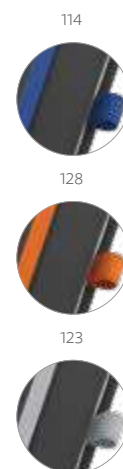

A6 Ruiz — 93722

 Caderno A6 com capa dura em c. sintético e 80 folhas pautadas.

± 90 x 140 mm

✂ SCR – 70 x 130 mm

Capas fluorescentes

O caderno que precisa para dar mais brilho às suas anotações.



Folhas com borda em preto



A5 **Watters** — 93269

Caderno A5 com capa dura em PU fluorescente. Contém 96 folhas pautadas brancas com a borda em preto, fita separadora e elástico.

140 x 210 mm

TR5 – 90 x 180 mm



109

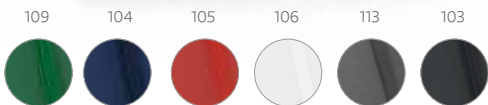

A5 Atwood A5 — 93492
 Caderno A5 em c. sintético com capa dura e 80 folhas não pautadas.
 140 x 210 mm
 SCR - 100 x 190 mm



105

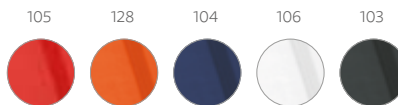

B6 Atwood B6 — 93723
 Caderno B6 com capa dura em c. sintético e 80 folhas não pautadas.
 120 x 170 mm
 SCR - 100 x 150 mm



128

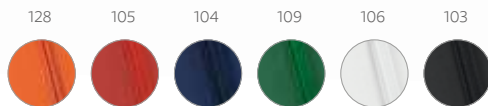

A6 Atwood A6 — 93493
 Caderno A6 em c. sintético com capa dura e 80 folhas não pautadas.
 90 x 140 mm
 SCR - 45 x 110 mm



104

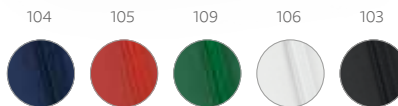

A6 Grimm — 93721
 Caderno A6 com capa dura em c. sintético e 80 folhas pautadas.
 90 x 140 mm
 SCR - 70 x 130 mm

Um Arco-Íris
de opções para
tirar notas
em qualquer
momento do dia



pocket

Meyer — 93425

Caderno de bolso com 80 folhas não pautadas,
capa dura em c. sintético, fita separadora e elástico.

90 x 140 mm

DUV – 70 x 120 mm

Cadernos de papel reciclado com argolas



119

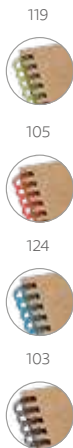

119

105

124

103

ECÓlogic



Garden — 93708

Caderno B6 espiral com 60 folhas pautadas de papel reciclado e capa dura em cartão com suporte para esferográfica (não inclusa).

140 x 180 mm

SCR – 80 x 50 mm



114

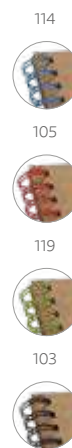

114

105

119

103

ECÓlogic



Marlowe — 93707

Caderno de bolso espiral com 60 folhas pautadas de papel reciclado e capa dura em cartão com elástico.

100 x 140 mm

SCR – 50 x 120 mm



109

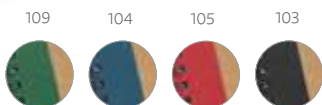

109

104

105

103

ECÓlogic



Asimov — 93715

Caderno B6 espiral com 60 folhas não pautadas de papel reciclado, capa dura em papel craft e suporte para esferográfica. Incluso esferográfica.

130 x 177 mm

SCR – 70 x 160 mm



104

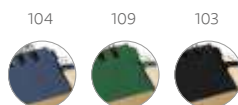

104

109

103

ECÓlogic



Ringord — 93427

Caderno de bolso espiral com 60 folhas não pautadas de papel reciclado, capa dura em cartão e suporte para esferográfica. Incluso esferográfica.

105 x 145 mm

TRS – 80 x 90 mm



119

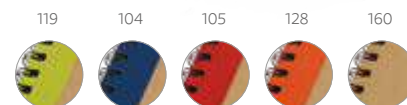

119

104

105

128

160

ECÓlogic



Cornish — 93428

Caderno A6 em cartão com capa dura e 60 folhas não pautadas de papel reciclado.

105 x 145 mm

SCR – 45 x 120 mm



Papel pedra

- Textura suave
- Impermeável
- Resistente
- Ecológico

Conjogue o seu caderno **Rock** com a esferográfica **Beta Bamboo** na página 137.

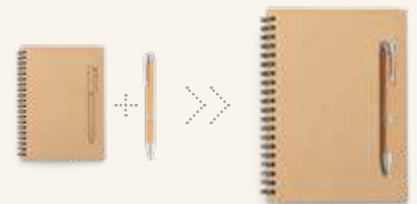

A



Capa dura em bambu

70 folhas em papel reciclado



160



160

Com suporte magnético para esferográfica

A

ecologic

- Dickens A6** — 93486
- A6 Caderno A6 espiral com capa dura em bambu, 70 folhas pautadas de papel reciclado e suporte para esferográfica. Esferográfica em bambu inclusa.
- 105 x 148 mm
- LSR - 55 x 118 mm

ecologic

- Dickens A5** — 93485
- A5 Caderno A5 espiral com capa dura em bambu, 70 folhas pautadas de papel reciclado e suporte para esferográfica. Esferográfica em bambu inclusa.
- 135 x 180 mm
- LSR - 85 x 140 mm

ecologic

- Rock** — 93419
- B6 Caderno B6 espiral com capa dura em papel craft e 70 folhas não pautadas em papel pedra de 120 g/m². Imã na capa que funciona como um suporte de esferográfica (não inclusa).
- 130 x 180 mm
- SCR - 70 x 160 mm



Escolhas mais simples, mas igualmente sustentáveis.



160



Com bolso interior

NEW

EcoLogic



Kostova — 93439



Caderno A5 com 40 folhas pautadas de papel reciclado e capa em cartão com bolso interior.



144 x 210 mm

SCR - 100 x 150 mm

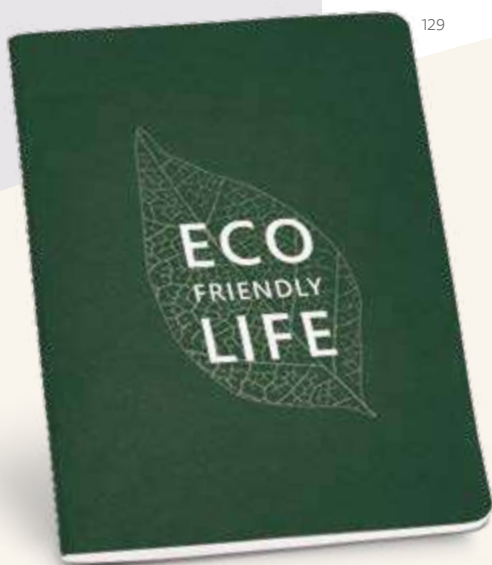

129



160

104

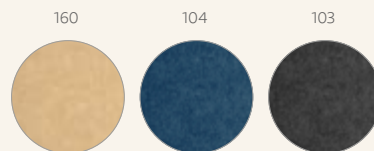
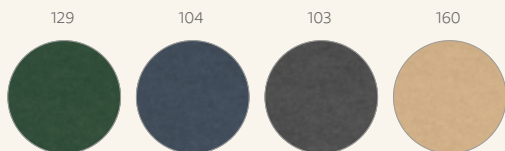

EcoLogic



Ecowin — 93495



Caderno A5 com 40 folhas pautadas e capa flexível em cartão.



140 x 210 mm

SCR - 120 x 190 mm



Bulfinch — 93461



Caderno B7 com 30 folhas não pautadas de papel reciclado e capa em cartão.



93 x 125 mm

SCR - 70 x 100 mm

Folhas costuradas
na lombada



ECologic

Alcott A4 — 93272

Caderno A4 com capa em cartão (250 g/m²) e cantos redondos. Contém 40 folhas não pautadas, costuradas, em papel reciclado proveniente de gestão florestal sustentável.

210 x 300 mm

SCR – 130 x 180 mm



ECologic

Alcott A5 — 93273

Caderno A5 com capa em cartão (250 g/m²) e cantos redondos. Contém 40 folhas não pautadas, costuradas, em papel reciclado proveniente de gestão florestal sustentável.

140 x 210 mm

SCR – 100 x 120 mm



ECologic

Alcott A6 — 93274

Caderno A6 com capa em cartão (250 g/m²) e cantos redondos. Contém 40 folhas não pautadas, costuradas, em papel reciclado proveniente de gestão florestal sustentável.

100 x 145 mm

SCR – 70 x 100 mm

Incluso lápis com borracha na ponta



ECologic



Bronte — 93422

Caderno A7 com 70 folhas não pautadas de papel reciclado, capa dura em cartão e elástico. Incluso lápis com borracha na ponta.

82 x 105 mm
SCR – 40 x 80 mm

ECologic



Flaubert — 93709

Caderno de bolso com 80 folhas não pautadas de papel reciclado e capa dura em cartão. Contém elástico e fita separadora.

100 x 140 mm
SCR – 60 x 110 mm



Lewis — 93426

7 blocos adesivados com 25 folhas cada e capa em cartão.

80 x 105 x 9 mm
SCR – 50 x 80 mm

Tazy — 93735

Porta cartões em craft com elástico, acompanha 6 blocos adesivados com 22 folhas cada.

104 x 65 x 5 mm
PDP – 30 x 50 mm



A



160

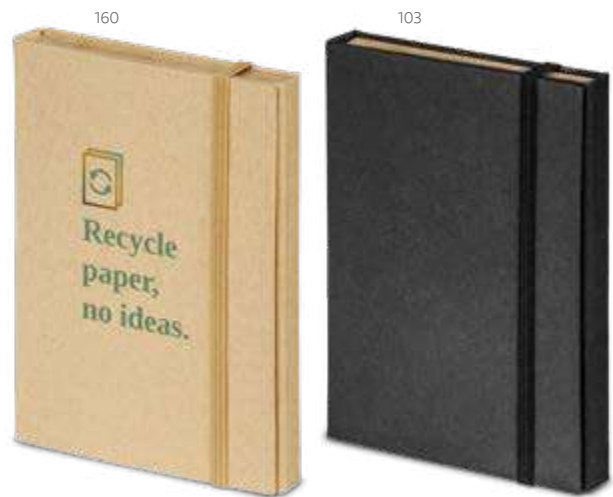

160

103



160

104

103

ECologic



Cooper — 93791



6 blocos adesivados com 25 folhas cada. Incluso caderno com 50 folhas não pautadas e esferográfica em papel craft.



100 x 150 mm

TR5 - 70 x 90 mm

ECologic



Eliot — 93792



Kit para escritório em cartão. Composto por caderno (80 folhas pautadas em papel reciclado), 6 blocos adesivados (25 folhas cada), 1 régua de 12 cm, 1 esferográfica em papel craft e suporte para cartões de visita.



110 x 153 mm

SCR - 60 x 130 mm



A

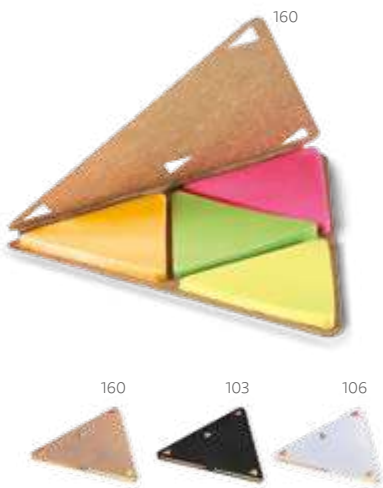

EcoLogic

Faulkner — 93794

4 blocos adesivados triangular com 25 folhas cada e com capa em cartão.

▮ 91 x 91 mm

▮ TRS - 35 x 30 mm



EcoLogic

Peter — 93718

6 blocos adesivados espiral com 25 folhas cada e capa em papel craft.

▮ 75 x 70 mm

▮ SCR - 50 x 35 mm



Stooky — 93421

5 blocos adesivados com 20 folhas cada.

∓ 80 x 60 x 3 mm

↗ SCR – 60 x 30 mm



James — 93448

7 blocos adesivados com 25 folhas cada e capa em cartão. Incluso régua de 12 cm com escala impressa.

∓ 159 x 50 x 3 mm

↗ SCR – 130 x 12 mm



Yeats — 53569

Porta crachá com clipe metálico com mecanismo extensível até aos 900 mm. Com presilha transparente e botão para adicionar bolsa porta-cartões. O mecanismo retrátil permite apresentar seu cartão ou credencial com segurança e comodidade.

∓ Ø32 x 9 mm

↗ PDP – 15 x 15 mm



Milton — 93476

∓ Caderno A7 espiral com 80 folhas não pautadas e capa semi-rígida em PP.

∓ 78 x 108 mm

↗ SCR – 30 x 60 mm



160

A

ECologic



Serpa — 92069



Pasta A4 em cortiça, com um bloco de 20 folhas não pautadas em cor marfim, suporte para esferográfica (não inclusa) e elástico. Fornecida em embalagem de non-woven.



239 x 307 x 17 mm | Bolsa: 285 x 350 mm

TR5 - 150 x 190 mm



A



160

Esferográfica inclusa

ECologic



Poe — 92046



Pasta A4 em cartão (450 g/m²) com um bloco de 20 folhas não pautadas de papel reciclado e suporte para cartão de visita.



Incluso esferográfica.
230 x 320 x 15 mm

SCR - 170 x 200 mm



160

ECologic



Puzo — 93463



Pasta porta-documentos A4 em cartão (400 g/m²) com dois bolsos no interior.

230 x 307 mm

SCR - 180 x 180 mm



• Flexível e direcionável

• Com carregador wireless

B



160

B

ecologic

Lezzo — 58517

Luminária de mesa em ABS e fibra de palha de trigo com carregador wireless. A haste é flexível para ajustar a direção da luz e contém 20 LEDs que permitem uma iluminação até 3 níveis de intensidade. No topo da luminária encontra-se um botão touch para ligar, desligar e ajustar os níveis de iluminação. O carregador sem fios é de carregamento rápido, tendo uma potência até 10W, com entradas 5V/2A e 9V/1.67A. No local onde o equipamento é colocado tem um círculo com silicone para evitar que se mova. Incluso cabo micro USB de 1 m. Fornecido em caixa presente de papel craft.

160 x 268 x 85 mm

PDP - Ø40 mm

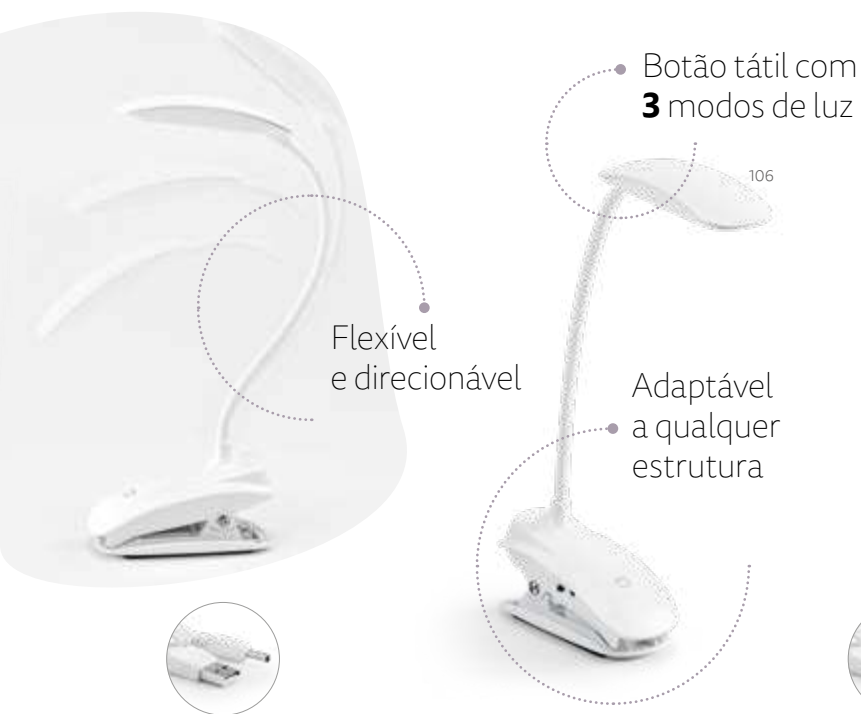

• Botão tátil com 3 modos de luz

• Flexível e direcionável

• Adaptável a qualquer estrutura

106

Conexão com smartphone e coluna de transmissão bluetooth.

• 18 LED's de alto brilho

106

Nesbit II — 54743

Luminária de mesa portátil em ABS e com LED COB. A luminária tem mola, braço flexível e botão tátil com 3 modos de luz (fraco, médio e forte). Autonomia até 20 horas. Incluso cabo USB de 1 metro para carregamento.

115 x 55 x 380 mm

PDP - 50 x 20 mm



Graham — 54734

Luminária de mesa com caixa de som em ABS. Com 18 LEDs de alto brilho, botão tátil e braço flexível. Transmissão por bluetooth e ligação stereo 3,5 mm com 5W/4Ω. Autonomia até 6 h e conexão à playlist do dispositivo móvel. Incluso cabo USB para carregar. Fornecida em caixa presente.

100 x 225 x 100 mm | Caixa: 110 x 235 x 105 mm

PDP - 50 x 12 mm



Bateria portátil com indicação de status de carregamento



Fecho flexível em silicone



• Suporte para celular



• Placa retroiluminada

A5 Oscar II — 52075

-  Pasta A5 em c. sintético com bateria portátil embutida (lítio). A bateria tem capacidade para 4.000 mAh, tempo de vida \geq 500 ciclos com entrada/saída 5V/1A e cabo USB/micro USB para carregar a bateria. No interior, contém um caderno removível com 64 folhas pautadas de cor marfim, um suporte para esferográfica (não inclusa) e elásticos para organização e suporte para smartphone. No exterior, uma placa com acabamento emborrachado, LED interior e botão on/off. Fornecida em caixa presente.

▮ 165 x 225 x 25 mm | Placa: 55 x 35 mm | Caixa: 180 x 240 x 35 mm

➤ LSR – 30 x 25 mm



103



A4 Christie — 92058

-  Pasta A4 em c. sintético e microfibr com 4 argolas de 20 mm e caderno com 20 folhas pautadas. Pen drive não inclusa.

▮ 265 x 340 x 45 mm

➤ TRS – 100 x 200 mm



103



A4 Paszo — 92044

-  Pasta A4 em c. sintético e microfibr. A pasta contém vários bolsos interiores, um bloco de 20 folhas pautadas e suporte para esferográfica (não incluída). Placa disponível para personalização.

▮ 245 x 325 x 40 mm | Chapa: 16 x 45 mm

➤ TRS – 150 x 250 mm



- Papel proveniente de uma gestão florestal sustentável



103



Emerge A5 Folder — 93581

6,5"

A5

LED

Pasta A5 em 300D rPET com carregador wireless embutido. A bateria tem capacidade para 5.000 mAh, potência de 10W, entrada/saída 5V/2.1A e cabo USB tipo C para carregar a bateria. A pasta contém no seu interior um bolso para smartphone até 6.5", três espaços para cartões, quatro luzes LED, botão on/off, suportes para esferográfica (não incluída), celular e cabo USB, um bloco de notas com capa em cartão preto e 64 folhas pautadas de cor marfim, em papel proveniente de gestão florestal sustentável. Na frente existe ainda uma impressão oval em preto para indicar a área de carga do wireless. Fornecido em caixa presente.

165 x 225 x 25 mm

PDP - 40 x 15 mm

Com carregador wireless



A4 Bielo — 92038

Pasta A4 em c. sintético, com bolso frontal e fecho. No interior tem vários bolsos e suporte para esferográfica (não inclusa). Contém um bloco com 20 folhas pautadas e calculadora dual-power de 8 dígitos, com pilha LR1130 inclusa.

250 x 345 x 20 mm

SCR – 130 x 130 mm



A4 Bocage — 92045

Pasta A4 em c. sintético e 1680D. Fecho magnético e bloco com 20 folhas pautadas. Esferográfica não inclusa.

245 x 325 x 15 mm | Chapa: 45 x 15 mm

LSR – 30 x 10 mm



A4 Clark — 92041

Pasta A4 em 600D com fecho elástico. A pasta contém um bloco de 20 folhas pautadas, 3 bolsos interiores e suporte para esferográfica (não inclusa).

240 x 325 x 15 mm

TRS – 180 x 100 mm

Pastas em linho sintético



A4 Salinger — 92068

Pasta A4 em linho sintético e c. sintético com placa metálica com acabamento emborrachado. No interior, contém um bloco (20 folhas pautadas), suporte para esferográfica (não inclusa) e outros compartimentos para acessórios (não inclusos).

259 x 336 x 27 mm | Placa: 50 x 30 mm

LSR - 40 x 25 mm



104



123



103



104

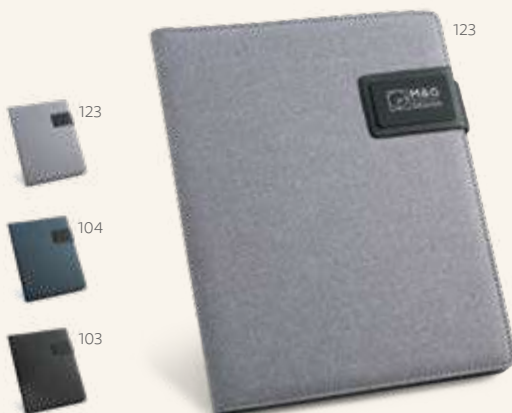

123



123



104



103



123



104



103



123



A5 Pynchon — 92066

Pasta A5 em linho sintético e c. sintético com fecho magnético. No interior, contém um bloco (20 folhas pautadas), suporte para esferográfica (não inclusa) e outros compartimentos para acessórios (não inclusos).

183 x 252 x 18 mm | Placa: 50 x 30 mm

LSR - 40 x 25 mm



A4 Riordan — 92067

Pasta A4 em linho sintético e c. sintético com fecho magnético. O interior contém um caderno de 20 folhas pautadas, suporte para esferográfica (não inclusa), bolso para smartphone e suportes para cabos ou outros acessórios (não inclusos). Placa metálica com acabamento emborrachado.

233 x 310 x 18 mm | Placa: 50 x 30 mm

LSR - 40 x 25 mm



124



124



105



123

A4 Fitzgerald — 92040

 Pasta A4 em c. sintético e 800D com o interior em microfibra. A pasta contém um elástico para fechar e no seu interior inclui um bloco de 20 folhas pautadas, 3 bolsos e suporte para esferográfica (não inclusa).

☒ 245 x 315 x 15 mm

☒ TRS - 150 x 250 mm



103

Irulan — 92630

Embalagem para pastas A4 em non-woven (90 g/m²).

☒ 390 x 290 mm

☒ TRS - 200 x 280 mm



Tecnologia





ekston®

Good things are always there

Prolongar instantes e experiências únicas através da tecnologia. A qualidade superior e a estética contemporânea da ekston® traduzem-se em produtos de performance excepcional que nos acompanham para todo o lado - uma extensão de experiências que exalta emoções e desafia os limites da tecnologia.

Saiba mais online

ekston.com



RELÓGIOS INTELIGENTES



Inox **Thiker I**
57431

103



O THIKER I é um sofisticado relógio inteligente resistente à água com bracelete em aço inox e transmissão por bluetooth 4.2 (compatível com versões iguais ou superiores Android 5.0 e iOS 9.0). O THIKER I é um aliado para o dia-a-dia através de múltiplas funcionalidades: pedômetro, acesso a notificações e conexão à playlist do dispositivo móvel, monitorização do sono, frequência cardíaca, geolocalizador, despertador, entre outras. Tem uma resolução de tela de 240 x 240 px, capacidade de 230 mAh e autonomia em uso até 72 horas e em standby até 7 dias. Fornecido em caixa presente.



┌ 26 x 47 x 8 mm | Caixa: 120 x 120 x 70 mm

└ DUV – 35 x 70 mm



CARACTERÍSTICAS:

- Resistente à água
- Sensor batimento cardíaco
- Monitorização do sono
- Conexão à playlist do dispositivo móvel
- Despertador
- Notificações do dispositivo móvel



Thiker II
97431

101



O THIKER II é um moderno relógio inteligente com bracelete em c. sintético de alta qualidade, que se adequa a diferentes ocasiões devido ao seu elegante design. Com transmissão via bluetooth 4.2 (compatível com versões iguais ou superiores Android 5.0 e iOS 9.0) e várias úteis funcionalidades como: pedômetro, acesso a notificações e conexão à playlist do dispositivo móvel, monitorização do sono, frequência cardíaca, geolocalizador, despertador, entre outras. O THIKER II tem uma resolução de tela de 240 x 240 px, capacidade de 230 mAh e autonomia em uso até 72 horas e em standby até 7 dias. Fornecido em caixa presente.



┌ 26 x 47 x 8 mm | Caixa: 120 x 120 x 70 mm

└ SCR – 70 x 35 mm



CARACTERÍSTICAS:

- Resistente à água
- Sensor batimento cardíaco
- Monitorização do sono
- Conexão à playlist do dispositivo móvel
- Despertador
- Notificações do dispositivo móvel



Metronome
97429

103



O Metronome é um relógio inteligente moderno e sofisticado com detalhes que lhe atribuem um design intemporal e simultaneamente inovador. Com um tela de 240 x 240 dpi e 1.3", o GPS integrado e a sua resistência à água elevam a singularidade deste relógio inteligente, tornando-se um aliado essencial no dia-a-dia. Tem ainda outras funcionalidades como o sensor de batimento cardíaco, monitorização do sono, notificações e conexão à playlist do dispositivo móvel via bluetooth 4.0 (compatível com versões iguais ou superiores Android 5.0 e iOS 9.0). Capacidade de 450 mAh e autonomia em uso até 48 horas e em standby até 7 dias. Fornecido em caixa presente.



┌ 26 x 50 x 10 mm | Caixa: 120 x 120 x 70 mm

└ DUV – 35 x 70 mm



CARACTERÍSTICAS:

- Resistente à água
- Sensor batimento cardíaco
- Monitorização do sono
- Conexão à playlist do dispositivo móvel
- Notificações do dispositivo móvel
- GPS integrado



FONES DE OUVIDO



107

Descry 97922

Os DESCRY são uns elegantes fones de ouvido wireless em metal e ABS. Suas características técnicas oferecem um objeto de elevada funcionalidade. Contêm uma transmissão por bluetooth 5.0 e têm um alcance até 10 m. Suas funcionalidades incluem: microfone, botão para atender chamadas e conexão à playlist do dispositivo móvel. O estojo de carregamento está incluso, é compatível com conector micro USB e tem uma capacidade de 500mAh. Os fones têm uma potência de 20Hz-20kHz e potência de 5mW (32Ω). A sua autonomia em uso é até 3 h e em standby até 300 h. Fornecidos em caixa presente.

∓ 31 x 78 x 38 mm | Caixa de carregamento: 79 x 40 x 32 mm | Caixa: 128 x 110 x 58 mm

∓ PDP – 50 x 10 mm



CARACTERÍSTICAS:

- Microfone
- Botão para atender chamadas
- Conexão à playlist do dispositivo móvel
- Caixa de carregamento

103

Wiretap 97926

Os WIRETAP são fones de ouvido wireless com transmissão por bluetooth 5.0 em metal e ABS de design arrojado e distinto. Ao permitir o isolamento de som e ao serem resistentes à água, os WIRETAP distinguem-se pela sua qualidade e pelas suas funcionalidades que incluem microfone, botão para atender chamadas e conexão à playlist do dispositivo móvel. Os fones têm um alcance de 10 m e frequência de 20-20kHz e potência 5mW (32Ω). A sua autonomia em uso é até 6h e em standby até 100h. O estojo de carregamento tem uma capacidade até 500 mAh, e é compatível com carregador por indução e conector micro USB. Fornecidos em caixa presente.

∓ 45 x 76 x 29 mm | Caixa: 126 x 124 x 49 mm

∓ PDP – 25 x 10 mm



CARACTERÍSTICAS:

- Microfone
- Botão para atender chamadas
- Conexão à playlist do dispositivo móvel
- Caixa de carregamento
- Resistente à água



103

Groovy 97928



Os GROOVY são fones de ouvido com microfone, confortáveis e elegantes, em c. sintético, metal e ABS. Os GROOVY são wireless dobráveis, práticos e ideais para o dia-a-dia com uma capacidade de bateria de 300 mAh e autonomia até 15 h. A transmissão é por bluetooth 4.2 com um alcance até 10 metros. A potência são 100 mW (32Ω) e frequência 20Hz-20kHz. Seus botões permitem controlar o volume, atender chamadas e interagir com a playlist do dispositivo móvel. Incluso cabo para carregar. Fornecidos em caixa presente.

📏 200/225 x 215 x 73 mm | Caixa: 265 x 250 x 65 mm

📦 PDP - 30 x 30 mm



CARACTERÍSTICAS:

- Dobráveis
- Microfone
- Controle de volume
- Botão para atender chamadas
- Conexão à playlist do dispositivo móvel
- Inclui cabo

FONES DE OUVIDO



103

Hearkeen 97919



Os HEARKEEN são fones de ouvido versáteis em ABS e silicone, perfeitos para diversos momentos do dia-a-dia. Devido ao seu design versátil, podem ser usados em ambientes mais profissionais, ou na prática esportiva. A transmissão por bluetooth 5.0, elevam a praticidade destes fones, com um alcance sem fios até 10 m. Têm uma frequência de 20Hz-20kHz e potência de 5mW(16Ω). Suas funcionalidades incluem botão para atender chamadas, controle de volume e conexão à playlist do dispositivo móvel. A capacidade da bateria é de 90mAh e a autonomia em uso é até 8h e em standby é até 6 dias. Incluso cabo. Fornecido em caixa presente.

↳ Auriculares (cada): 33 x 16 x 24 mm | Comprimento da faixa do pescoço: 455 mm | Caixa: 201 x 220 x 40 mm
 ↗ PDP – 20 x 5 mm



CARACTERÍSTICAS:

- Microfone
- Botão para atender chamadas
- Controle de volume
- Conexão à playlist do dispositivo móvel



107

Vibration 97923



Os VIBRATION são fones de ouvido, com fios, em metal e ABS de design moderno que se destacam pelo seu acabamento metalizado nos vários detalhes do produto. Tem uma frequência de 20Hz-20kHz (16Ω), microfone e botão para atender chamadas. Incluso cabo de 1,3 m (Jack 3,5 mm). Fornecidos em caixa presente.

↳ 20 x 18 x 20 mm | Caixa: 88 x 97 x 45 mm
 ↗ LSR – 14 x 3 mm



CARACTERÍSTICAS:

- Microfone
- Botão para atender chamadas
- Conexão à playlist do dispositivo móvel

CAIXA DE SOM



103

Blare 97257



A BLARE é uma caixa de som com microfone de design moderno e discreto em ABS. A caixa é um objeto que se torna um parceiro para todos os momentos devido às suas características técnicas e funcionais como botão para atender chamadas e conexão à playlist do dispositivo móvel. A BLARE tem transmissão por bluetooth 5.0, alcance até 10 m e frequência de 90Hz-20kHz. A sua capacidade é de 500 mAh, 3W/4Ω e tem autonomia até 6 h. Incluso cabo para carregar e entrada AUX para Jack 3,5mm. Fornecida em caixa presente.

┆ 60 x 63 x 70 mm | Caixa: 120 x 139 x 83 mm

┆ PDP – 20 x 30 mm



CARACTERÍSTICAS:

- Microfone
- Botão para atender chamadas
- Conexão à playlist do dispositivo móvel
- Inclui cabo



133

Thunder 97258



A THUNDER é uma caixa de som com microfone em tecido texturado e ABS de design elegante e acabamentos detalhados. Com transmissão bluetooth 5.0 e alcance até 10 m, é um objeto que se enquadra na perfeição num ambiente elegante e sofisticado. A THUNDER tem uma capacidade de 1 200 mAh, potência de 2x3W (3Ω) e autonomia até 5h. A frequência é de 150-180kHz. Contém entrada AUX para Jack 3,5mm. Fornecida em caixa presente.

┆ 73 x 196 x 54 mm | Caixa: 275 x 123 x 74 mm

┆ SCR – 40 x 15 mm



CARACTERÍSTICAS:

- Microfone
- Botão para atender chamadas
- Controle de volume
- Conexão à playlist do dispositivo móvel

+ CARREGADORES WIRELESS BATERIAS PORTÁTEIS



103

LED Magnet 97920



O MAGNET é um carregador wireless robusto, de design moderno em zinco e acrílico. Este carregador é compatível com smartphones que têm tecnologia de carregamentos sem fios, ideal para usar comodamente em casa ou no escritório. Incluso indicador de carga LED e tem uma potência de carregamento máxima de 10W. Com cabo USB-C de 1 metro incluso. Fornecido em caixa presente.

108 x 96 x 15 mm | Caixa: 157 x 179 x 34 mm
LSR – 20 x 5 mm



CARACTERÍSTICAS:

- Compatível com smartphones que têm tecnologia de carregamentos sem fios

133

LED Horde 97921



O HORDE é um carregador wireless que funde liga de zinco e tecido num cruzamento perfeito que culmina num objeto de design elegante e sofisticado. O HORDE é compatível com smartphones que têm tecnologia de carregamentos sem fios, tornando-se um aliado para o dia-a-dia. Contém indicador de carga LED e tem uma potência de carregamento máxima de 15W. Com cabo USB-C de 1 metro incluso. Fornecido em caixa presente.

101 x 87 x 16 mm | Caixa: 169 x 154 x 34 mm
LSR – 30 x 3 mm



CARACTERÍSTICAS:

- Compatível com smartphones que têm tecnologia de carregamentos sem fios

107

LED **Think 97916**

A THINK é uma versátil bateria portátil com uma base de carregamento em ABS e PC que permite simultaneamente ser usada como um carregador wireless. A THINK é um objeto de design arrojado e dadas as suas características técnicas tanto pode ser usado em viagens (como bateria portátil) ou como carregador wireless. Bateria em polímero de lítio com indicador de carga LED. Possibilita o carregamento de até 2 dispositivos em simultâneo, com entrada USB tipo C e saídas USB tipo C e USB tipo A. Capacidade de 10 000 mAh e potência de carregamento wireless de 10W. Fornecida em caixa presente, com cabo de 1 m incluído.

┌ 145 x 90 x 97 mm | Caixa: 212 x 195 x 58 mm
 ↗ PDP – 50 x 30 mm



CARACTERÍSTICAS:

- Carrega 2 dispositivos em simultâneo
- Indicador de carga LED
- Compatibilidade universal
- Bateria polímero de lítio



133

LED **Trencher 97925**

A TRENCHER é uma bateria portátil forrada a tecido numa estrutura em ABS com acabamento em borracha que se distingue pelo seu design moderno, elegante e simultaneamente, intimista. Bateria em polímero de lítio com indicador de carga LED. Possibilita o carregamento de até 2 dispositivos em simultâneo com entrada DC 5V/2.1A e saída DC 5V/1-2.1A. Prática e moderna bateria portátil com capacidade de 10 000 mAh e potência de carregamento de 5V. Fornecida em caixa presente, com cabo USB tipo C incluso.

┌ 140 x 70 x 16mm | Caixa: 212 x 112 x 29 mm
 ↗ SCR – 45 x 15 mm



CARACTERÍSTICAS:

- Carrega 2 dispositivos em simultâneo
- Indicador de carga LED
- Compatibilidade universal
- Bateria polímero de lítio



103

LED **Crowd 97917**

A Crowd é uma bateria portátil em ABS de design elegante e inovador pensada de forma a ser um objeto intuitivo e facilitador no dia-a-dia. Bateria em polímero de lítio com indicador de carga LED. Possibilita o carregamento de até 2 dispositivos em simultâneo com entrada DC 5V/2.0A e saída DC 5V/1-2.1A. Bateria prática para levar para qualquer lugar com capacidade de 5 000 mAh e potência de carregamento de 5V. Fornecida em caixa presente, com cabo micro USB incluso.

┌ 98 x 64 x 14 mm | Caixa: 148 x 144 x 34 mm
 ↗ DUV – 35 x 45 mm



CARACTERÍSTICAS:

- Carrega 2 dispositivos em simultâneo
- Indicador de carga LED
- Compatibilidade universal
- Bateria polímero de lítio





Coleção Bambu

O melhor da tecnologia aliada ao bambu: um material natural e amigo do ambiente.



B

A



A

NEW

ecologic



 **Tilly** — 97095

 Caixa de som portátil em ABS reciclado e bambu. Com potência de 3W e transmissão por bluetooth 5.0 e função de rádio. Tempo de reprodução até 5h com uma bateria de 1200 mAh. Fornecido em caixa presente de papel craft.

 135 x 40 x 65 mm

 LSR – 60 x 40 mm

Função de rádio



B

NEW

ecologic



 **Mayer** — 97098

 Caixa de som portátil em ABS reciclado e bambu. Com potência de 3W e transmissão por bluetooth 5.0 e função de rádio. Tempo de reprodução até 4h com uma bateria de 500 mAh. Fornecido em caixa presente de papel craft.

 70 x 70 x 37 mm

 LSR – 50 x 12 mm

Função de rádio



ECologic

Fitch Eco — 57909

Bateria portátil com carregador wireless em bambu. Bateria de lítio com capacidade de 5.000mAh e tempo de vida \geq 500 ciclos. Contém entrada/saída de 5V/2A, indicador de carga, 1 porta micro USB, 1 porta USB tipo C e 1 porta USB. Potência de saída wireless, no máximo, de 5W. Incluso cabo USB / micro USB para carregar. Compatível com smartphones com tecnologia de carregamento sem fios. Fornecido em caixa presente de papel craft.

∓ 140 x 70 x 12 mm

↗ LSR - 120 x 50 mm

ECologic

Kohn 5.0 — 57915

Bateria portátil em bambu com bateria de lítio com capacidade de 5.000 mAh e tempo de vida \geq 500 ciclos. Entrada 5V/2A e saída 5V/1-2A com 1 porta micro USB, 1 porta USB tipo C e 1 porta USB. Inclui cabo USB / micro USB para carregar e contém indicador de carga. Fornecido em caixa presente de papel craft.

∓ 120 x 51 x 15 mm

↗ LSR - 80 x 30 mm



Darwin II — 57390

Relógio em MDF com calendário, alarme e termômetro. Incluso 4 pilhas AAA, 1 pilha CR2032 e cabo USB. Fornecido em caixa presente.

∓ 150 x 70 x 44 mm | Caixa: 170 x 92 x 54 mm

↗ SCR - 120 x 25 mm



ECologic

Glashow Eco — 57256

Caixa de som com microfone em bambu. Transmissão por bluetooth 3.0, ligação stereo 3,5 mm e leitor de cartões TF e potência de 3W (4Ω). Bateria com capacidade até 300 mAh e autonomia até 3 horas. Função para atender chamadas, controle de volume, conexão à playlist do dispositivo móvel e rádio FM. Incluso cabo USB / micro USB para carregar e cabo de áudio (Jack/Jack). Fornecida em caixa presente de papel craft.

∓ Ø60 x 52 mm

↗ PDP - 20 x 25 mm





Suporte para esferográficas



ECologic

Leavitt II — 57940

Carregador wireless de bobina dupla em bambu com suporte para esferográficas. Potência de carregamento rápida de 10W e com entradas 5V/2A e 9V/1.67A. Incluso cabo de carregamento USB tipo C de 1m. Fornecido em caixa presente de papel craft.

▮ 77 x 71 x 118 mm

▮ LSR – 60 x 80 mm



Atalla — 97539 / 97540

▮ .97



ECologic

Ecopower — 57910

Carregador wireless em bambu. Entradas 5V/2A e potência máxima de carregamento de 5W. Incluso cabo USB/micro USB de 1m para carregar. Compatível com smartphones com tecnologia de carregamento sem fios.

▮ 92 x 92 x 9 mm

▮ LSR – 70 x 70 mm



ECologic

Motto — 57911

Organizador de mesa em bambu e ABS. Incluso carregador wireless, hub USB e suporte para celular. Entrada 5V/1.5A. Potência de saída, no máximo, de 5W. 1 porta USB e 1 porta USB tipo C. Incluso cabo USB/tipo C, de 90 cm, para carregar. Compatível com smartphones com tecnologia de carregamento sem fios. Fornecido em caixa presente de papel craft.

▮ 255 x 135 x 14 mm

▮ LSR – 120 x 60 mm



160



ECologic



Maxwell — 57932

Suporte para celular com carregador wireless em fibra de palha de trigo e ABS. Com uma potência de carregamento rápida de 10W e com entradas 5V/2A e 9V/1.67A. Incluso cabo de carregamento micro USB de 1 m. Fornecido em caixa presente de papel craft.

∓ 70 x 112 x 87 mm

➤ PDP – 40 x 30 mm



160



ECologic



Piyon — 57936

Caixa de som portátil em fibra de palha de trigo e ABS com alça em silicone para facilitar o transporte, potência de 3W e transmissão por bluetooth 5.0. Tempo de reprodução de 4h30, com uma bateria de 500 mAh. Incluso cabo micro USB. Fornecido em caixa presente de papel craft.

∓ 70 x 70 x 34 mm

➤ PDP – 40 x 40 mm



160



ECologic



Cuvier II — 57929

Carregador wireless em ABS e fibra de palha de trigo. A potência de carregamento é de 5W, com entrada 5V/2A. A base contém um círculo em silicone para o equipamento não se mova enquanto carrega. Incluso cabo micro USB de 1 m. Fornecido em caixa presente de papel craft.

∓ Ø70 x 10 mm

➤ PDP – Ø30 mm



Coleção de Palha de Trigo

Produtos tecnológicos numa versão mais sustentável.



ECÓlogic



Galois — 57930

Caixa de som portátil em fibra de palha de trigo e ABS com microfone. Potência de 3W e transmissão por bluetooth 5.0. Com tempo de reprodução de 2 horas e uma bateria de 300 mAh. Incluso cabo micro USB. Fornecido em caixa presente de papel craft.

∅62 x 48 mm

PDP – 15 x 20 mm



ECÓlogic



Lezzo — 58517



Luminária de mesa em ABS e fibra de palha de trigo com carregador wireless. A haste é flexível para ajustar a direção da luz e contém 20 LEDs que permitem uma iluminação até 3 níveis de intensidade. No topo da luminária encontra-se um botão touch para ligar, desligar e ajustar os níveis de iluminação. O carregador sem fios é de carregamento rápido, tendo uma potência até 10W, com entradas 5V/2A e 9V/1.67A. No local onde o equipamento é colocado tem um círculo com silicone para evitar que se mova. Incluso cabo micro USB de 1 m. Fornecido em caixa presente de papel craft.

160 x 268 x 85 mm

PDP – Ø40 mm

Flexível e direcionável



Com carregador wireless

160



Tecnologia sustentável

O uso de matérias naturais estendeu-se também ao universo tecnológico, criando peças únicas e mais amigas do ambiente.



A

ECÓlogic

Marconi — 57939

Fones de ouvido dobráveis wireless em fibra de palha de trigo e ABS. Potência de 32mW e transmissão bluetooth 5.0 com alcance até 10m. Bateria com capacidade de 400mAh e tempo de reprodução até 13 horas. Incluso porta AUX, slot para cartão TF/SD e cabo de carregamento micro USB. Botões de controle com +/- e ligar/desligar. Fornecido em caixa presente de papel craft.

📏 Auscultadores (fechados): 185 x 185 x 74 mm |
Caixa: 120 x 90 x 160 mm

📏 PDP – 20 x 40 mm



Com microfone

ECÓlogic

Fourier Tw — 57938

Fones de ouvido True Wireless em fibra de palha de trigo e PP, com transmissão por bluetooth 5.0 até 10m de distância e tempo de reprodução até 3 horas (standby até 10h). Cada fone tem um botão multifunções e microfone integrado, facilitando atender chamadas em modo mãos-livres, e indicador luminoso LED. O estojo de carregamento tem uma bateria de 300 mAh e indicador de status de carregamento e bateria. Incluso um cabo de carregamento micro USB. Fornecido em caixa presente de papel craft.

📏 80 x 38 x 32 mm

📏 PDP – 25 x 10 mm

O aliado certo para o trabalho remoto



Controle de volume

B

Conexão USB A

Autonomia até **12h**



147



113

B

NEW

Hopper — 57935

 Fones de ouvido em ABS e PU com microfone, transmissão por bluetooth 5.0 e potência de 30 mW. A bateria tem uma capacidade de 300 mAh e tempo de reprodução de 12 horas. Produto com cabo de carregamento micro USB incluso. Fornecido em caixa de oferta.

195 x 165 x 88 mm | 210 mm

PDP – 20 x 10 mm



Kilby — 97088

Fone de ouvido ajustável com microfone em ABS e PP. Inclui um controle de som com 4 botões: aumentar/diminuir volume, desligar microfone e sem som. Frequência de resposta de 20Hz-20KHz, impedância 32Ω, cabo de 1,85 m e conexão por USB A. Fornecidos em caixa presente.

170 x 185 x 75 mm

X

Permite emparelhamento com 2 dispositivos móveis em simultâneo



Fone com estrutura almofadada



Fones de ouvido dobráveis



103



Edwin Bk — 57355

Fone de ouvido ajustáveis em ABS, com acabamento emborrachado e transmissão por bluetooth. Autonomia até 5 h. Função para atender chamadas, controle de volume e conexão à playlist do dispositivo móvel. Permite emparelhamento com 2 dispositivos móveis em simultâneo. Incluso cabo USB / micro USB para carregar. Fornecido em caixa presente.

157 x 165 x 42 mm | Caixa: 161 x 200 x 55 mm

PDP – 30 x 10 mm



105

Botão para atender chamadas



Bannon — 57365

Fone de ouvido dobrável e ajustável em ABS com estrutura almofadada, transmissão por bluetooth e leitor de cartões TF. Autonomia até 4 h. Função para atender chamadas, controle de volume, conexão à playlist do dispositivo móvel e rádio FM. Incluso cabo micro USB para carregar. Fornecido em caixa presente.

Dobrados: 165 x 135 x 70 mm | Caixa: 150 x 150 x 70 mm

PDP – 30 x 15 mm



Spirited — 97205
 .364



106
 Fone magnético

• Banda de pescoço

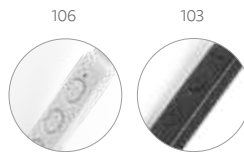

 **Medley** — 57914

Fone de ouvido em PC. Transmissão por bluetooth com banda para pescoço com autonomia até 7 horas. Função para atender chamadas, controle de volume e conexão à playlist do dispositivo móvel. Incluso cabo USB / micro USB para carregar. Fornecido em bolsa em non-woven.

± 190 x 200 mm
 ↗ PDP – 6 x 30 mm



114



103

A

 **Wilkins** — 97341

Fone de ouvido desportivo em ABS e silicone com transmissão por bluetooth. Autonomia até 3 h. Função para atender chamadas e conexão à playlist do dispositivo móvel. Incluso cabo micro USB para carregar. Fornecido com bolsa em non-woven.

± 150 x 135 x 50 mm
 ↗ PDP – 40 x 10 mm



103

• Fone magnético



106

103

 **Ottoflex** — 57913

Fone de ouvido em PC. Transmissão por bluetooth 4.1 com autonomia até 3 horas. Função para atender chamadas, controle de volume e conexão à playlist do dispositivo móvel. Incluso cabo USB / micro USB para carregar. Fornecido em bolsa em EVA.

± 80 x 65 x 32 mm
 ↗ DUV – 40 x 30 mm

Com microfone
incorporado



119

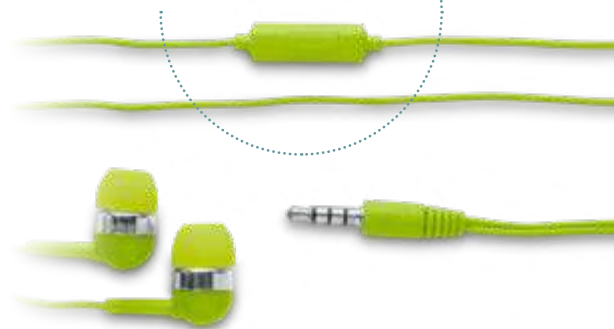

119

114

105

106

103

NEW

Osler — 97092

Fone de ouvido com microfone incorporado e cabo de 1,20 m com ligação stereo 3,5 mm. Inclui 2 pares extra de adaptadores de fone em silicone (dois tamanhos diferentes). Fornecidos em caixa de PS e ABS.

Caixa: 70 x 70 x 18 mm

SCR - 50 x 50 mm



114



105



106



103

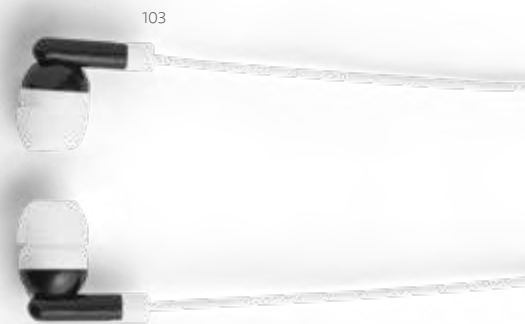

103



Farday — 57360

Fone de ouvido com cabo de 1,25 m com ligação stereo 3,5 mm. Fornecido em caixa de PS/ABS.

Caixa: 60 x 64 x 16 mm

SCR - 25 x 25 mm

Práticos e fáceis de levar para qualquer lado



NEW

Kandel — 97912

Fone de ouvido wireless stereo em ABS. Transmissão por bluetooth com autonomia até 6 horas. Função para atender chamadas, controle de volume e conexão à playlist do dispositivo móvel. Inclui cabo USB / micro USB para carregar. Fornecidos em caixa com função de carregador.

📏 71 x 55 x 28 mm | Auricular: 47 x 21 x 21 mm

🔪 PDP – 25 x 20 mm



106



103



A



NEW

Klebs — 97085

Fone de ouvido True Wireless em ABS com microfone e caixa de carregamento de 250mah. Transmissão por bluetooth 5.1, autonomia até 1.5h, frequência 20Hz-20KHz, 98 dB e impedância de 32Ω. Cada fone tem um botão multifunções e a caixa tem uma porta micro USB para ser carregada. Fornecidos em caixa.

📏 Auricular: 47 x 19 x 8 mm | Caixa: 55 x 64 x 26 mm

🔪 PDP – 20 x 20 mm

Presilha em silicone para transporte



103



114



103



123



123

Rubin — 57934

Fones de ouvido wireless stereo em ABS com transmissão por bluetooth 5.0 e tempo de reprodução até 3 horas. O estojo de carregamento, com uma bateria 250 mAh, é também em ABS e contém uma presilha em silicone que permite transportar e carregar os fones de forma fácil e cómoda. Produto com cabo de carregamento micro USB incluso. Fornecido em caixa de oferta.

📏 77 x 36 x 30 mm

🔪 PDP – 50 x 12 mm

Rubin Wh — 57937

Fones de ouvido wireless stereo em ABS com transmissão por bluetooth 5.0 e tempo de reprodução de 3 horas. O estojo de carregamento, com uma bateria 250 mAh, é também em ABS e contém uma presilha em silicone que permite transportar e carregar os fones de forma fácil e confortável. Produto com cabo de carregamento micro USB incluso. Fornecido em caixa presente.

📏 77 x 36 x 30 mm

🔪 PDP – 40 x 10 mm

As caixas de som também vêm acompanhando as novas tendências, utilizando tecidos de qualidade e de variadas cores para dar o toque que faltava no seu novo espaço de trabalho



Alça para transporte



A

Gent — 57395

Caixa de som com microfone em ABS, tecido em poliéster e acabamento emborrachado. Transmissão por bluetooth, ligação stereo 3,5 mm e leitor de cartões TF. Potência de 3W/4Ω. Função para atender chamadas, controle de volume, conexão à playlist do dispositivo móvel e rádio FM. Incluso cabo USB para carregar. Fornecida em caixa presente.

120 x 80 x 40 mm | Caixa: 142 x 85 x 45 mm

TRS – 60 x 20 mm

Ecclus — 57385

Caixa de som com microfone em ABS e tecido em poliéster. Com gancho e acabamento emborrachado. Transmissão por bluetooth, potência de 3W/4Ω e autonomia até 3 h. Função para atender chamadas, controle de volume e conexão à playlist do dispositivo móvel. Incluso cabo para carregamento. Fornecida em caixa presente.

Ø90 x 40 mm | Caixa: 115 x 95 x 45 mm

PDP – 20 x 7 mm



B



B

Grubbs Bk — 57933

Caixa de som portátil em ABS com acabamento em borracha e tecido na parte frontal. De design sofisticado, esta caixa de som tem um tempo de reprodução de 2 horas, com transmissão por bluetooth 5.0 e potência de 3W. Adicionalmente tem também a funcionalidade de carregador wireless, com uma potência de 5 W, com entrada 5V/2A e bateria de 300 mAh. Incluso cabo de carregamento micro USB. Fornecida em caixa presente.

108 x 56 x 54 mm
PDP – 35 x 15 mm



Chion — 97396

Caixa de som com microfone em ABS, tecido em poliéster e acabamento emborrachado. Transmissão por bluetooth, ligação stereo 3,5 mm e leitor de cartões TF. Potência de 3W/4Ω. Função para atender chamadas, controle de volume, conexão à playlist do dispositivo móvel e rádio FM. Incluso cabo USB para carregar. Fornecida em caixa presente.

140 x 80 x 45 mm | Caixa: 160 x 82 x 60 mm
PDP – 50 x 8 mm



Harris — 97397

Caixa de som com microfone em ABS, tecido em poliéster e acabamento emborrachado. Transmissão por bluetooth, ligação stereo 3,5 mm e leitor de cartões TF. Com 2 x 3W/4Ω. e autonomia até 3 h. Função para atender chamadas, controle de volume, conexão à playlist do dispositivo móvel e rádio FM. Incluso cabo USB para carregar. Fornecida em caixa presente.

155 x 230 x 55 mm | Caixa: 170 x 260 x 70 mm
TRS – 60 x 110 mm



- Holly** — 57335
- Caixa de som com microfone em ABS, com transmissão por bluetooth, ligação stereo 3,5 mm e leitor de cartões TF, com 3W/4Ω e autonomia até 3 h. Função para atender chamadas, controle de volume e conexão à playlist do dispositivo móvel. Com apoio antideslizante para celular. Incluso cabo USB para carregar. Fornecida em caixa presente.
- ∓ Ø85 x 66 mm | Caixa: 93 x 93 x 85 mm
 ↗ PDP – 20 x 10 mm



- Euclidean** — 57340
- Caixa de som com microfone em ABS e acabamento emborrachado. Transmissão por bluetooth, potência de 3W/4Ω e autonomia até 3 h. Função para atender chamadas, controle de volume e conexão à playlist do dispositivo móvel. Incluso cabo USB para carregar. Fornecida em caixa presente.
- ∓ 150 x 56 x 58 mm | Caixa: 155 x 60 x 60 mm
 ↗ PDP – 30 x 5 mm



- Perry** — 57253
- Caixa de som com microfone em ABS e acabamento emborrachado. Transmissão por bluetooth e leitor de cartões TF. Com 3W/4Ω e autonomia até 2h. Função para atender chamadas, controle de volume e conexão à playlist do dispositivo móvel. Incluso cabo USB / micro USB para carregar.
- ∓ Ø59 x 55 mm
 ↗ PDP – 25 x 8 mm



- Bow** — 97328
- Caixa de som à prova de água em ABS e acabamento emborrachado com ventosa. Transmissão por bluetooth e potência de 3W/4Ω. Autonomia até 3 h. Função para atender chamadas, controle de volume e conexão à playlist do dispositivo móvel. Incluso cabo para carregamento. Fornecida em caixa presente.
- ∓ Ø85 x 50 mm | Caixa: 88 x 88 x 55 mm
 ↗ PDP – 25 x 7 mm



Personalizável com logótipo iluminado

103



A

 **Edison Bk** — 57255

 Caixa de som portátil, com luz LED no interior, em ABS e acabamento emborrachado. (personalizável com logótipo iluminado). Transmissão por bluetooth 4.2 e potência de 3W (4Ω). Bateria com 300 mAh e autonomia superior a 2h. Incluso cabo 2 em 1: USB / micro USB para carregamento e micro USB/3.5 jack. Fornecida em caixa.

∓ 59 x 59 x 51 mm

↗ LSR – 30 x 15 mm



 **Symfony** — 57927

 Caixa de som com transmissão por bluetooth e microfone. Com potência de 3W e transmissão por bluetooth 4.0 com alcance de 10m. A capacidade da bateria é de 500 mAh e o tempo de carregamento de 2-3 horas. Tem autonomia até 8 horas, microfone incorporado para chamadas e conferências. Tem botão start/stop e capacidade para rádio FM. Compatível com todos os dispositivos e permite transmissão por bluetooth. Inclui cabo USB/DC 5 V/jack. Fornecida em caixa presente.

∓ Ø60 x 50 mm | Caixa 97 x 87 x 95 mm

↗ LSR – 20 x 20 mm



 **Florey II** — 57252

 Caixa de som com microfone em alumínio, com transmissão por bluetooth e leitor de cartões TF com 3W/4Ω. Autonomia até 5h. Função para atender chamadas, controle de volume, conexão à playlist do dispositivo móvel e rádio FM. Incluso cabo micro USB para carregar. Fornecida em caixa presente.

∓ Ø71 x 42 mm | Caixa: 80 x 80 x 60 mm

↗ LSR – 20 x 15 mm

Caixa esterilizadora que permite a eliminação de bactérias



Carregador wireless de carregamento rápido



LED Germout — 58519



Caixa esterilizadora em ABS e PC com combinação entre radiação UVC e UVA que permite a eliminação de um número significativo de bactérias. A caixa possui 2 leds UV no interior com uma potência total de 2W, e foi especialmente desenhada para a eliminação de bactérias em objetos de uso diário, como: chaves, celulares, smartphones, máscaras, óculos, comandos, jóias, e outros pequenos utensílios. Eficiência de 70% com apenas 1 ciclo de 5 minutos, e 99,9% com dois ciclos de 5 minutos. Possui um sensor de segurança que desliga de imediato as lâmpadas assim que é aberta a caixa. A parte superior da caixa incluso um carregador wireless de carregamento rápido (10W), com entrada de 5V/3A e porta de carregamento USB tipo C. Incluso cabo de 1 metro. Fornecida em caixa presente.

📏 210 x 120 x 55 mm | Interior: 190 x 95 x 20 mm |

Caixa: 240 x 130 x 71 mm

🔪 SCR – 150 x 70 mm



Lagrange — 97087

Óculos de realidade virtual em ABS para celulares de 4,7" a 6,5" Com elásticos laterais e superior e lentes ajustáveis. Compatíveis com Android e iOS e com qualquer aplicação disponível em Play Store e AppStore para realidade virtual.

📏 200 x 130 x 110 mm

🔪 PDP – 55 x 15 mm



Iluminação interativa e sofisticada para o local de trabalho



Flexível e direcionável

Botão tátil com **3** modos de luz

Adaptável a qualquer estrutura



Nesbit II — 54743

Luminária de mesa portátil em ABS e com LED COB. A luminária tem mola, braço flexível e botão tátil com 3 modos de luz (fraco, médio e forte). Autonomia até 20 horas. Incluso cabo USB de 1 metro para carregamento.

115 x 55 x 380 mm

PDP - 50 x 20 mm

Conexão com smartphone e coluna de transmissão bluetooth.

18 LED's de alto brilho



Graham — 54734

Luminária de mesa com caixa de som em ABS. Com 18 LEDs de alto brilho, botão tátil e braço flexível. Transmissão por bluetooth e ligação stereo 3,5 mm com 5W/4Ω. Autonomia até 6 h e conexão à playlist do dispositivo móvel. Incluso cabo USB para carregar. Fornecida em caixa presente.

100 x 225 x 100 mm | Caixa: 110 x 235 x 105 mm

PDP - 50 x 12 mm



Emerge Collection

Pastas multifunções que vão tornar sua vida mais prática e sustentável.



Papel proveniente de uma gestão florestal sustentável



• Com carregador wireless



103



Emerge A5 Folder — 93581

Pasta A5 em 300D rPET com carregador wireless embutido. A bateria tem capacidade para 5.000 mAh, potência de 10W, entrada/saída 5V/2.1A e cabo USB tipo C para carregar a bateria. A pasta contém no seu interior um bolso para smartphone até 6.5", três espaços para cartões, quatro luzes LED, botão on/off, suportes para esferográfica (não incluída), celular e cabo USB, um bloco de notas com capa em cartão preto e 64 folhas pautadas de cor marfim, em papel proveniente de gestão florestal sustentável. Na frente existe ainda uma impressão oval em preto para indicar a área de carga do wireless. Fornecido em caixa presente.

165 x 225 x 25 mm

PDP - 40 x 15 mm



Tecnologia sustentável

A melhor tecnologia, aliada ao material mais sustentável do momento.

A



113



NEW

EcoLogic



Renewal Battery — 97094

Bateria portátil 100% rPET, com bateria de lítio, capacidade de 5.000 mAh e entrada/saída de 5V/2A. Inclui uma porta para microUSB, uma porta USB-C e duas portas USB. Fornecida em caixa presente de papel craft.

⊥ 65 x 98 x 10 mm

↗ TRS – 80 x 40 mm



113



NEW

EcoLogic



Renewal Charger — 97093

Carregador wireless 100% rPET. A potência de carregamento é de 10W, com entradas 5V/1.6A e 9V/1.5A. Inclui cabo de 1 m. Fornecido em caixa presente de papel craft.

⊥ 100 x 62 x 10 mm

↗ TRS – 80 x 40 mm

Carregamento Wireless

Leve para todo o lado sem precisar de cabos.



103



103

106

113

Aldrin X — 57904

 Bateria portátil em ABS com acabamento emborrachado que permite o carregamento do dispositivo por indução. Bateria de lítio com capacidade de 10.000 mAh e tempo de vida \geq 500 ciclos. Com entrada/saída 5V/2.1A e potência de carregamento de 5W. Indicador de carga e portas USB, micro USB e USB tipo C. Incluso cabo USB / micro USB para carregar a bateria. Compatível com smartphones com tecnologia de carregamento sem fios. Fornecida em caixa presente.

\pm 135 x 75 x 20 mm | Caixa: 150 x 95 x 25 mm

 PDP - 45 x 30 mm



103



106



Inclui ventosas para facilitar o uso durante a viagem



Azofi — 97079

 Bateria portátil e carregador wireless em alumínio com LED indicador de carga. Bateria polímero de lítio com capacidade de 4.000 mAh. Entrada 5V/2A e saída 5V/2A e potência de carregamento: 5W. Incluso cabo USB / micro USB para carregar a bateria. Fornecido em caixa presente.

\pm 126 x 71 x 14 mm

 PDP - Ø25 mm



Cassini 4.0 — 57078

Bateria portátil e carregador wireless em alumínio com bateria de polímero de lítio. Contém uma capacidade de 4.000 mAh e tempo de vida de ≥ 500 ciclos. Entrada 5V/2A e saída 5V/2A, com LED indicador de carga. Incluso cabo USB / micro USB para carregar a bateria. Fornecida em caixa presente.

123 x 70 x 10 mm

LSR - 35 x 25 mm



Coulomb 4.0 — 57344

Bateria portátil slim em alumínio. Bateria de lítio com capacidade de 4.000 mAh, tempo de vida ≥ 500 ciclos e com entrada/saída 5V/1A. Incluso cabo USB / micro USB para carregar a bateria. Fornecida em caixa presente.

110 x 68 x 10 mm

LSR - 90 x 50 mm



Energia sem limites!

Deixe de se preocupar com a bateria dos seus dispositivos! A alta capacidade destas baterias permite vários carregamentos e compatibilidade com vários dispositivos. Para além disso, podem ir com você para qualquer lugar sem ocupar muito espaço.



Capacidade de **16.000** mAh

Indicador de carga e LED

Raman Bk — 57905

Bateria portátil em ABS, com LED. Contém bateria de lítio com capacidade de 16.000 mAh e tempo de vida superior a 1.000 ciclos. Tem entrada 5V/2.1A, saída 5V/1-2.1A, indicador de carga, 2 portas USB e 1 porta micro USB. A bateria tem proteção para sobrecarga, curto circuito e sobreaquecimento. Incluso cabo USB/micro USB para carregamento. Fornecida em caixa presente.

156 x 80 x 23 mm | Caixa: 175 x 100 x 30 mm

SCR – 55 x 100 mm



Zack 7.2 — 57351

Bateria portátil em alumínio. Bateria de lítio com capacidade de 7.600 mAh e tempo de vida ≥ 500 ciclos. Com entrada 5V/1A, saída 5V/1-2.1A e 2 portas USB. Incluso cabo USB/micro USB para carregar a bateria. Fornecida em caixa presente.

150 x 74 x 12 mm | Caixa: 165 x 80 x 20 mm

LSR – 120 x 50 mm



Lumina X — 97945

Bateria portátil em ABS com LED. Bateria de lítio com capacidade de 10.000 mAh e tempo de vida ≥ 500 ciclos. Com entrada 5V/1A, saída 5V/1-2.1A e 2 portas USB. Incluso cabo USB/micro USB para carregar a bateria.

150 x 70 x 11 mm

SCR – 130 x 50 mm



Emlyn — 97384

Bateria portátil em alumínio. Bateria de lítio com capacidade de 8.000 mAh, tempo de vida ≥ 500 ciclos e com entrada/saída 5V/1A. Incluso cabo USB/micro USB para carregar a bateria. Fornecida em caixa presente.

90 x 77 x 22 mm | Caixa: 110 x 85 x 25 mm

LSR – 70 x 50 mm



Energia limpa

Recarregue a sua bateria sem ligar na tomada. Aproveite o sol e desfrute das boas energias.



103



Day — 97371



Bateria portátil solar em ABS com painel solar e LED. Bateria de lítio com capacidade de 2.000 mAh, entrada/saída 5V/1A e 2 portas USB. Incluso cabo USB / micro USB para carregar a bateria. Fornecida em caixa presente.

143 x 77 x 16 mm | Caixa: 165 x 80 x 20 mm

SCR - 50 x 20 mm



103



103

127



Ceres — 97314



Bateria portátil em alumínio com painel solar e LED. Bateria de lítio com capacidade de 8.000 mAh e tempo de vida \geq 500 ciclos. Com entrada 5V/1A, saída 5V/1-2.1A e 2 portas USB. Incluso cabo USB / micro USB para carregar a bateria. Fornecida em caixa presente.

155 x 75 x 10 mm | Caixa: 175 x 100 x 30 mm

LSR - 100 x 50 mm



113



123



Omar 2.0 — 57391

Bateria portátil em ABS. Bateria de lítio com capacidade de 2.000 mAh, tempo de vida ≥ 500 ciclos e com entrada/saída 5V/1A. Incluso cabo USB/ micro USB para carregar a bateria. Fornecida em caixa presente.

112 x 42 x 25 mm | Caixa: 173 x 96 x 30 mm

SCR – 60 x 15 mm



127

103

Lambda 4.0 — 97943

Bateria portátil em alumínio. Bateria de lítio com capacidade de 4.000 mAh, tempo de vida ≥ 500 ciclos e com entrada/saída 5V/1A. Incluso cabo USB/ micro USB para carregar a bateria. Fornecida em caixa presente.

91 x 56 x 24 mm

LSR – 80 x 32 mm

Inclui cabo USB/ micro USB



106



103



103



106

Hubble — 97076

Bateria portátil em ABS. Bateria polímero de lítio com capacidade de 4.000 mAh, tempo de vida ≥ 500 ciclos, entrada 5V/1A e saída 5V/1A. 1 porta USB. Incluso cabo USB/ micro USB para carregar a bateria. Fornecida em caixa presente.

102 x 52 x 22 mm

PDP – 55 x 25 mm



103



106

Barium 4.0 — 97942

Bateria portátil em ABS. Bateria de lítio com capacidade de 4.000 mAh, tempo de vida ≥ 500 ciclos e com entrada/saída 5V/1A. Incluso cabo USB/ micro USB para carregar a bateria.

100 x 55 x 25 mm

SCR – 90 x 45 mm



A



106

Inclui ventosas •



Gagarin — 97394

Bateria portátil em ABS com ventosas na base. Bateria de lítio com capacidade de 4.000 mAh, tempo de vida \geq 500 ciclos e com entrada/saída 5V/1A.

Incluso cabo USB / micro USB para carregar a bateria.

⌘ Bateria: 123 x 50 x 14 mm | Base: 65 x 58 x 10 mm

➤ DUV – 80 x 40 mm



104

103

106

A



104

106

103

Sagan — 97077

Bateria portátil em ABS e aço inox com tela touch e indicador de carga. Bateria polímero de lítio com capacidade de 4.000 mAh e tempo de vida \geq 500 ciclos. Entrada 5V/1A e saída 5V/1A. Incluso cabo USB / micro USB para carregar a bateria. Fornecido em caixa presente.

⌘ 116 x 65 x 7 mm

➤ PDP – 55 x 25 mm



Leo 2.2 — 57323

Bateria portátil em alumínio. Bateria de lítio com capacidade de 2.200 mAh, tempo de vida ≥ 500 ciclos e com entrada/saída 5V/1A. Incluso cabo USB/ micro USB para carregar a bateria.

▮ 95 x 23 x 22 mm

▮ LSR – 80 x 13 mm



Leo 1.8 — 97376

Bateria portátil em alumínio. Bateria de lítio com capacidade de 1.800 mAh, tempo de vida ≥ 500 ciclos e com entrada/saída 5V/1A. Incluso cabo USB/ micro USB para carregar a bateria.

▮ 95 x 23 x 22 mm

▮ LSR – 85 x 13 mm



Boole 1.5 — 97946

Bateria portátil em ABS. Bateria de lítio com capacidade de 1.500 mAh, tempo de vida ≥ 500 ciclos e com entrada/saída 5V/1A. Incluso cabo USB/ micro USB para carregar a bateria. Fornecida em caixa presente.

▮ 100 x 28 x 23 mm

▮ PDP – 50 x 15 mm



Bit — 97162 / 97941 / 97944

Bateria portátil em ABS. Tempo de vida ≥ 500 ciclos e com entrada/saída 5V/1A. Incluso cabo USB/ micro USB para carregar a bateria.

97162: capacidade 1.000 mAh

97941: capacidade 1.600mAh

97944: capacidade 2.000 mAh

▮ 96 x 22 x 24 mm

▮ TP – 97 x 944 mm



Transforme seu pen drive em um presente exclusivo com a caixa de presente



Simon 8Gb — 97434

Pen Drive UDP mini com 8GB em alumínio. Fornecida em caixa em PP.

☒ 33 x 12 x 6 mm | Caixa: 68 x 25 x 15 mm

🔪 PDP – 25 x 8 mm

ecologic

Atalla — 97539 / 97540

Pen drive em bambu. 97539: capacidade 8GB 97540: capacidade 16GB

☒ 59 x 19 x 12 mm

🔪 TP – 97 x 540 mm



Signy — 97348

Caixa para pen drive em cartão.

☒ 115 x 60 x 26 mm

🔪 SCR – 90 x 45 mm



Penrose — 97517 / 97528 / 97529

Pen drive com memória COB em alumínio.

97517: capacidade 8GB

97528: capacidade 16GB

97529: capacidade 32GB

☒ 12 x 37 x 5 mm

🔪 TP – 97 x 529 mm



Weinberg — 97527 / 97543

Pen drive em c. sintético.

97527: capacidade 8GB

97543: capacidade 16GB

☒ 80 x 21 x 16 mm

🔪 TP – 97 x 543 mm



Mosfet — 97525 / 97541

Pen drive em c. sintético.

97525: capacidade 8GB

97541: capacidade 16GB

☒ 58 x 27 x 12 mm

🔪 TP – 97 x 541 mm

Conjuge com os carregadores rápidos

57906 / 57907 / 57908



Steven — 57154

Estação de carregamento USB em ABS com 5 saídas 5V/4A. Incluso cabo com 1,5 m.

∓ 65 x 110 x 80 mm

➤ PDP – 20 x 50 mm



Redy — 57362

Adaptador USB. ABS. Com 2 saídas 5V/1-2.1A.

∓ 62 x 42 x 23 mm

➤ DUV – 30 x 30 mm



Caine — 57326

Kit de adaptadores USB em ABS. Incluso adaptador de corrente DC 110V/220V e adaptador para carro DV 12-24V. Fornecido com bolsa EVA.

∓ Bolsa: 112 x 80 x 45 mm

➤ TRS – 70 x 45 mm



Newton II — 57312

Kit de adaptadores USB em ABS. Incluso adaptador de corrente DC 110V/220V e adaptador para carro DV 12-24V. Fornecido com bolsa EVA.

∓ Bolsa: Ø75 x 36 mm

➤ SCR – Ø40 mm

SUPER FAST

Conjogue com o adaptador

57362

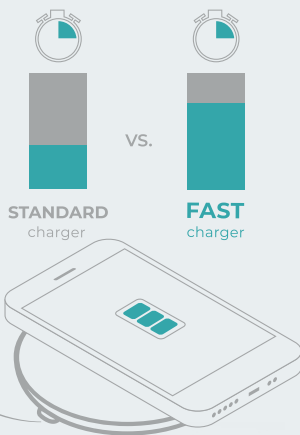

Jolly — 57907

Carregador wireless rápido em ABS e alumínio. Com entradas 5V/2A e 9V/1,67A e potência de carregamento 5W, 7.5W e 10W. Incluso cabo USB / micro USB para carregar. Compatível com smartphones com tecnologia de carregamento sem fios. Fornecido em caixa presente.

⊞ Carregador: Ø100 x 9 mm | Cabo: 1000 mm
 ↗ PDP – 50 x 30 mm



Burnell Bk — 57908

Carregador wireless rápido em ABS com acabamento emborrachado. Entradas 5V/2A e 9V/1,67A. Potência máxima de carregamento de 10W. Incluso cabo USB / micro USB de 1 m para carregar. Compatível com smartphones com tecnologia de carregamento sem fios. Fornecido em caixa.

⊞ Ø99 x 9 mm | Cabo: 1000 mm
 ↗ LSR – Ø50 mm

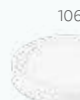
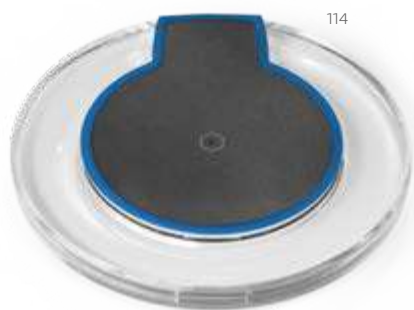

Hyper — 57906

Carregador wireless rápido em ABS e silicone. Tem entrada 5V/2A e 9V/1.67A. Potência máxima de carregamento de 5W, 7.5W e 10W. Incluso cabo USB / micro USB para carregar. Compatível com smartphones com tecnologia de carregamento sem fios. Fornecido em caixa presente.

⊞ Ø69 x 10 mm
 ↗ PDP – Ø40 mm



106



Carson — 57346

Carregador wireless em ABS e que permite carregamento do dispositivo por indução. Tem entrada 5V/2A e potência de carregamento de 5W. Incluso cabo USB / micro USB para carregar. Compatível com smartphones com tecnologia de carregamento sem fios.

⊞ Ø100 x 10 mm
 ↗ PDP – 40 x 25 mm



103



Alencar — 97399

Mouse wireless dobrável 2.4G. em ABS com acabamento emborrachado. Incluso 2 pilhas AAA. Fornecido em caixa transparente.

∓ 60 x 112 x 20 mm | Caixa: 75 x 130 x 44 mm

➤ **DUV** – 40 x 90 mm



105



105

114



106

103



Blackwell 2.4 — 57304

Mouse wireless 2.4G. em ABS. Incluso 2 pilhas AAA. Fornecido em caixa transparente.

∓ 57 x 113 x 20 mm | Caixa: 64 x 120 x 36 mm

➤ **PDP** – 30 x 20 mm



119



114



113

Crick 2.4 — 57398

Mouse wireless 2.4G. em ABS com Acabamento emborrachado. Incluso 2 pilhas AAA.

∓ 65 x 105 x 20 mm

➤ **PDP** – 40 x 8 mm



104



104

106

103



119



119

114

105

106

103



106



106

Jannes — 97318

Hub USB 2.0. com 4 portas para conectar até 4 dispositivos móveis.

∓ 52 x 41 x 12 mm

➤ **DUV** – 40 x 20 mm

Gardner — 97357

Hub USB 2.0 em ABS com 4 portas.

∓ Ø52 x 18 mm

➤ **PDP** – Ø35 mm

Emmy — 97153

Cabo USB 3 em 1 em ABS e PVC. Adequado para carregar dispositivos móveis. Dispõe de um conector USB tipo C e um conector 2 em 1, compatível com entradas micro USB e sistema operacional iOS. Fornecido em caixa de PP.

∓ Caixa: Ø53 x 20 mm

➤ **PDP** – Ø35 mm

Adaptador 5 em 1

Para que nunca lhe falte nenhuma ligação.



IOS e USB-C



Micro USB



Tipo A



NEW

ecologic



Rubins — 97091

Cabo retrátil 5 em 1 em ABS e bambu. Uma das extremidades é USB-C com adaptador para USB-A, enquanto que na outra extremidade existe uma ponta especial 2 em 1 micro-usb e iOS com adaptador para USB-C. Entrada/saída: 5V/1A. Fornecido em caixa presente de papel craft.

∓ 40 x 130 mm | Cabo esticado: 40 x 850 mm

LSR - Ø30 mm



106

A



103



127

NEW

Minsky — 97090

Conjunto de adaptadores em alumínio composto por: 1 adaptador de USB-A para USB-C e 1 adaptador de USB-C para USB-A. Tecnologia USB 2.0. Fornecido em caixa individual em PP.

∓ 37 x 40 x 18 mm

DUV - 20 x 20 mm



119



Shelley — 93320

Porta cartões para celular em silicone com autocolante no verso.

∓ 57 x 87 x 3 mm

✂ SCR – 35 x 35 mm



128



106



Carver — 93321

Porta cartões para celular em silicone com autocolante no verso e suporte para smartphone.

∓ 57 x 96 x 5 mm

✂ PDP – 50 x 10 mm



103



Nicolaus — 94446

Porta cartões em silicone com cordão e suporte para celular.

∓ Porta-cartões: 57 x 86 x 4 mm | Lanyard: 420 mm

✂ SCR – 35 x 35 mm



109



Bell — 93264

Porta cartões para celular em PVC com autocolante.

∓ 56 x 89 x 1 mm

✂ SCR – 40 x 45 mm





Bloqueio RFID

Garanta a segurança dos seus cartões e evite o roubo de dados.



Muller — 93332

Porta cartões em alumínio com bloqueio de RFID e fita elástica em poliéster. O porta cartões tem acabamento mate e capacidade para 12 cartões. Seu formato compacto e funcionalidade de bloqueio RFID permitem que seja guardado de forma cómoda e segura em bolsos.

▮ 90 x 58 mm

▮ LSR – 50 x 20 mm



Franck — 93331

Porta cartões para celular em PU com bloqueio de RFID, com capacidade para dois cartões. O porta cartões tem fita ajustável em PU e autocolante no verso.

▮ 102 x 63 x 3 mm

▮ PDP – 40 x 10 mm



Block — 93334

Porta-cartões para celular em PU com bloqueio de RFID, capacidade para 1 cartão e autocolante no verso.

▮ 92 x 62 x 3 mm

▮ SCR – 45 x 45 mm



Poppy — 93265

Porta cartões em PU com bloqueio de RFID e fita em poliéster para retirar facilmente seus cartões. Com capacidade para guardar até 2 cartões.

▮ 92 x 65 mm

▮ SCR – 45 x 45 mm

Direção mais segura

Com os suportes de celular para carro.



Uler — 57338
Porta celular para carro em ABS.
┆ 50 x 97 x 28 mm
┆ PDP – Ø15 mm



Wallis — 97366
Porta celular para carro em ABS.
┆ 40 x 78 x 25 mm
┆ PDP – 33 x 9 mm



Hooke — 97367
Suporte para celular em ABS e TPR.
┆ Fechado: 89 x 30 x 9 mm
┆ SCR – 45 x 25 mm



Georges — 97150
Suporte de anel para celular em ABS com autocolante no verso.
┆ 35 x 40 x 6 mm
┆ PDP – 25 x 6 mm

Proteja a sua privacidade com os nossos protetores para webcam

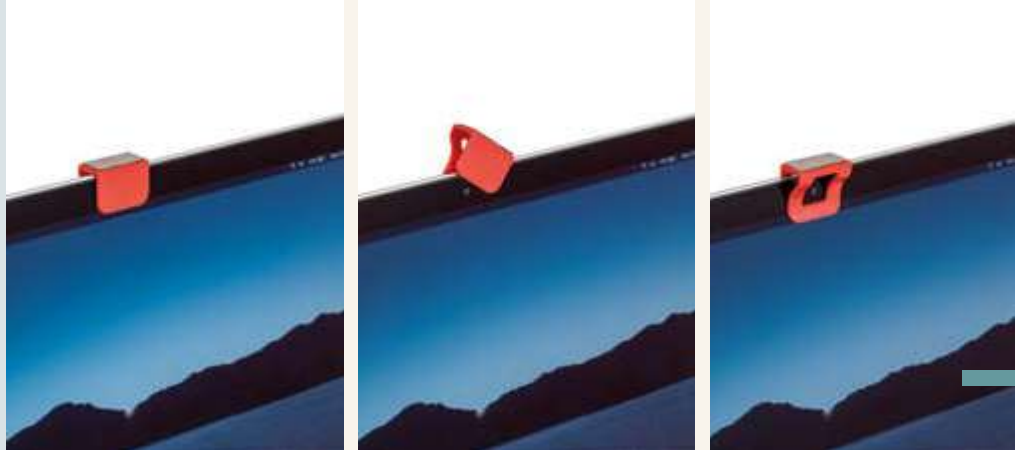

NEW

Moniz — 97950

Protetor de webcam em formato clip com limpador de tela. Adequado para tablet e notebook.

▮ 24 x 12 x 22 mm |
Limpador de tela: 22 x 10 mm

➤ PDP – 20 x 8 mm



Rosat — 97952

Protetor para webcam em PP com tampa deslizante e autocolante no verso. Formato universal para smartphone, tablet, notebook e computador de secretária.

▮ 42 x 17 x 2 mm | Aberto: 65 x 17 x 2 mm

➤ PDP – 22 x 7 mm



Galilei — 97951

Protetor para webcam em PP com tampa deslizante e autocolante no verso. Formato universal para smartphone, tablet, notebook e computador de secretária.

▮ 32 x 13 x 1,5 mm | Aberto: 43 x 13 x 1,5 mm

➤ PDP – 25 x 8 mm



103



103

104



14"

Seattle — 92290

Pasta para notebook em soft shell de alta densidade para notebook até 14" com bolso frontal com zíper.

▮ 370 x 280 x 30 mm

▮ TRS – 220 x 100 mm

14"

Avery — 92352

Bolsa em soft shell para notebook até 14".

▮ 355 x 280 x 30 mm

▮ TRS – 260 x 190 mm



Escrita

INKUOTE COLLECTION

Para aqueles que não dispensam escrever em papel

Transpor para o papel pensamentos e ideias - o culto da escrita à mão. Instrumentos de escrita que combinam diferentes texturas num design moderno e elegante. A fluidez da tinta como ritmo da inspiração. A INKUOTE como mentora das palavras soltas e acertadas.

A

103



Sign I 81206

Inox



A SIGN I é uma elegante esferográfica em metal, com acabamento preto mate, clipe em aço inox. A SIGN I é um objeto sofisticado e de design minimalista que tem recarga Dokumental Ink® e escrita azul. Fornecida em caixa presente.

∅10 x 135 mm | Caixa: 53 x 187 x 28 mm

LSR - 40 x 5 mm

B

103



Sign II 81207

Inox



O SIGN II é um elegante roller em metal, com acabamento preto mate e clipe em aço inox. O SIGN II tem recarga Dokumental Ink® e que escrita preta. Fornecido em caixa presente.

∅10 x 135 mm | Caixa: 53 x 173 x 28 mm

LSR - 40 x 5 mm

C

103



Autograph 81205

Inox



O AUTOGRAPH é um conjunto sofisticado de esferográfica e roller. O roller é em metal com acabamento preto mate e tampa com clipe em aço inox e a esferográfica é em metal, com acabamento preto mate e clipe em aço inox. Neste minimalista e requintado conjunto a esferográfica e roller têm recarga Dokumental Ink® com escrita azul. Fornecida em caixa presente.

∅10 x 135 mm | Caixa: 75 x 30 x 190 mm

LSR - 40 x 5 mm

D

127



Stain 81208

Inox



O STAIN é um roller em metal, texturado e tampa com clipe em aço inox. O roller STAIN foi desenhado com inspiração em linhas geométricas. Contém recarga Dokumental Ink® e escrita preta. Fornecido em caixa presente.

∅10 x 135 mm | Caixa: 53 x 173 x 28 mm

LSR - 40 x 4 mm



A

B



INKUOTE COLLECTION

A



Neo
81001

127 103 143



A NEO é uma esferográfica vanguardista e ergonômica em alumínio, com mecanismo twist, que foi concebida a pensar nos profissionais que fazem do caderno e do tablet o seu escritório. A ponteira touch, em silicone, permite reforçar a sua utilidade e o corpo laqueado com acabamento matt/brilhante confere muita elegância. A esferográfica tem recarga em metal e tinta Dokumental® preta. Fornecida em caixa presente.

∅ 11 x 138 mm | Caixa: 55 x 30 x 190 mm

LSR - 50 x 5 mm

B



Hook Matte
81003

147 127



A esferográfica HOOK Matte é elegante e sofisticada, que dificilmente passa despercebida. Trata-se de uma esferográfica em bronze, com mecanismo twist, cromagem brilhante e clipe com mola em ferro, que lhe garante força e flexibilidade. A ponteira em bronze com cromagem brilhante e o corpo com duplo acabamento (interior platinado e exterior laqueado mate) reforçam, não só o design elegante, como a qualidade da HOOK Matte. Tem recarga em metal G2, com tinta Dokumental® azul. Fornecida em caixa presente.

∅ 11 x 138 mm | Caixa: 187 x 53 x 28 mm

LSR - 45 x 6 mm

A



A





B

A

B



ROLLER



ESFEROGRÁFICA + ROLLER



ESFEROGRÁFICA



103



103



103



Ezekiel Roller — 81196

Roller em metal com clipe e acabamento em dourado. Fornecida em estojo em papel craft.

∓ Ø11 x 140 | Caixa: 180 x 57 x 25 mm

➤ LSR - 40 x 6 mm



Ezekiel Set — 81210

Conjunto de esferográfica com mecanismo twist e roller em metal com clipe e detalhes em dourado. Fornecido em estojo almofadado.

∓ Ø11 x 140 | Caixa: 180 x 57 x 25 mm

➤ LSR - 40 x 6 mm



Ezekiel — 81195

Esferográfica em metal com mecanismo twist, clipe e apontamentos em dourado. Fornecida em estojo em papel craft.

∓ Ø11 x 139 | Caixa: 180 x 43 x 22 mm

➤ LSR - 40 x 6 mm



A



Banho de ouro de 18 quilates

A



Versailles — 81146

Conjunto de roller e esferográfica em metal. Elementos com banho de ouro de 18 quilates. Esferográfica: Até 1,5 km de escrita. Fornecido em estojo almofadado.

∅12 x 136 mm |
 Estojo: 185 x 75 x 31 mm
 LSR – 35 x 5 mm

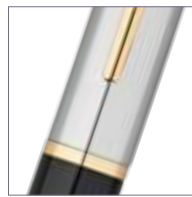

Banho de ouro de 18 quilates



Louvre — 91489

Esferográfica em metal. Clipe, anel e ponteira com banho de ouro de 18 quilates. Até 1,5 km de escrita. Fornecida em estojo almofadado.

∅12 x 139 mm |
 Estojo: 179 x 56 x 30 mm
 LSR – 25 x 6 mm



Para brindes mais completos e elegantes

Os conjuntos de esferográficas e rollers são a escolha certa.



Benton — 51842

Conjunto de roller e esferográfica em metal, ambos com clipe e escrita a preto. A esferográfica é de mecanismo twist e permite Até 1,5 km escrita. Incluso estojo almofadado.

∅13 x 136 mm | Estojo: 185 x 75 x 31 mm

LSR – 30 x 6 mm



Douro — 91816

Conjunto de roller e esferográfica com mecanismo twist, ambos em metal e com clipe. Esferográfica até 2 km de escrita. Fornecido em estojo almofadado.

∅12 x 132 mm | Estojo: 170 x 70 x 30 mm

LSR – 30 x 6 mm



B



 **Warhol** — 51836

Conjunto de roller e esferográfica em metal, ambos com clipe e escrita preta. Esferográfica com mecanismo twist. Até 1,5 km de escrita. Incluso estojo almofadado.

∓ Ø13 x 135 mm |
 Estojo: 185 x 75 x 31 mm
 ⚡ LSR – 30 x 6 mm



147



B



 **Orlando** — 81193

Conjunto de roller e esferográfica em metal com clipe. Fornecido em estojo almofadado.

∓ Esferográfica: Ø13 x 136 mm |
 Roller: Ø13 x 135 mm |
 Caixa: 192 x 34 x 85 mm
 ⚡ LSR – 40 x 6 mm



107

115



ROLLER



ESFEROGRÁFICA + ROLLER



ESFEROGRÁFICA



103



106



106



103



106



106



103



Caliop Roller — 81198

Roller em metal com clipe com detalhe brilhante na ponta. Fornecido em estojo de oferta. Escrita azul.

✂ Esferográfica: Ø10 x 136,5 mm |
Caixa: 182 x 22 x 42 mm

✂ LSR – 25 x 3 mm



Caliop Set — 81199

Conjunto de roller e esferográfica em metal com mecanismo twist e clipe com detalhe brilhante na ponta. Fornecido em estojo almofadado.

✂ Esferográfica: Ø10 x 133 mm |
Roller: Ø10 x 137 mm | Caixa: 180 x 57 x 25 mm

✂ LSR – 40 x 6 mm



Caliop — 81197

Esferográfica em metal com mecanismo twist e clipe com detalhe brilhante na ponta. Fornecida em estojo papel craft.

✂ Ø10 x 133 mm |
Caixa: 180 x 43 x 22 mm

✂ LSR – 25 x 3 mm

Caneta sem tinta

A alternativa mais inovadora às tradicionais esferográficas: permite apagar e tem uma ponta com escrita infinita.

Austen —
51917
📄 .158

NEW

Monet — 91792

Caneta sem tinta em alumínio com ponta de liga metálica com grafite capaz de durar por muito tempo. Não é necessário afiar e pode apagar o que escrever. Fornecida em caixa craft preta.

📏 Ø8 x 153 mm

🔪 PDP - 50 x 6 mm



Conjunto de roller e esferográfica



Ponteira touch e mecanismo twist



Doublette — 91844

Conjunto de roller e esferográfica em metal com ponteira touch e clipe. Esferográfica com mecanismo twist e até 1,5 km de escrita. Fornecida em estojo almofadado.

Esferográfica: Ø11 x 128,6 mm | Roller: Ø11 x 131,4 mm | Estojo: 175 x 55 x 25 mm

LSR – 35 x 5 mm



Haley — 91899

Conjunto de roller e esferográfica em alumínio com clipe. Esferográfica até 1,5 km de escrita. Fornecido em estojo almofadado.

Esferográfica: Ø11 x 138 mm | Estojo: 175 x 55 x 25 mm

LSR – 35 x 5 mm



103



127

Conjunto de esferográfica e lapiseira



Esferográfica



Lapiseira



Plock — 91834

Conjunto de esferográfica e lapiseira em alumínio. Esferográfica até 1,5 km de escrita. Lapiseira com grafite 0.5 mm. Incluso estojo.

Esferográfica: Ø11 x 137 mm | Estojo: 165 x 50 x 24 mm

LSR – 70 x 6 mm



107 106 103



 **Bern** — 91428

Roller em metal com clipe. Escrita a preto.
Fornecido em estojo presente almofadado.
∓ Ø12 x 136 mm | Estojo: 175 x 55 x 25 mm
▸ LSR - 30 x 7 mm



A



 **Blazon** — 81147

Roller em metal com suave relevo no corpo.
Fornecido em estojo presente almofadado.
Escrita preta.
∓ Ø11 x 137 mm | Estojo: 179 x 55 x 30 mm
▸ LSR - 35 x 5 mm





 **Silverio** — 81170
 Esferográfica em metal com corpo brilhante e clipe. Fornecida em estojo almofadado.
 ∅10 x 131 mm |
 Caixa: 182 x 22 x 42 mm
 LSR – 35 x 6 mm



 **Plata** — 91008
 Esferográfica em metal até 2 km de escrita. Incluso embalagem de veludo.
 ∅10 x 140 mm |
 Embalagem de veludo: 160 x 30 mm
 LSR – 30 x 5 mm

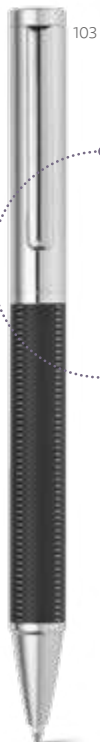

Mecanismo twist



 **Montreal** — 51348
 Esferográfica em metal com mecanismo twist e clipe. Até 2 km de escrita. Incluso embalagem de veludo.
 ∅11 x 138 mm |
 Embalagem de veludo: 160 x 30 mm
 LSR – 40 x 7 mm



Mecanismo twist



 **Deli** — 91814
 Esferográfica em metal. Até 1,5 km de escrita. Incluso embalagem de veludo.
 ∅12 x 135 mm |
 Embalagem de veludo: 160 x 30 mm
 LSR – 30 x 5 mm



Elegância multifuncional

Muito mais do que escrever, estas esferográficas têm várias funções para que nada fique por fazer.



A



Lapoint — 81201



Esferográfica multifunções em metal com clipe. Esferográfica com mini lanterna LED, apontador laser e ponteira touch. Incluso 3 pilhas LR41. Fornecida em estojo metálico com forro de veludo.



∅10 x 125 mm | Caixa: 178 x 38 x 19 mm

LSR – 80 x 25 mm



127



Ponteira laser

Ponteira touch

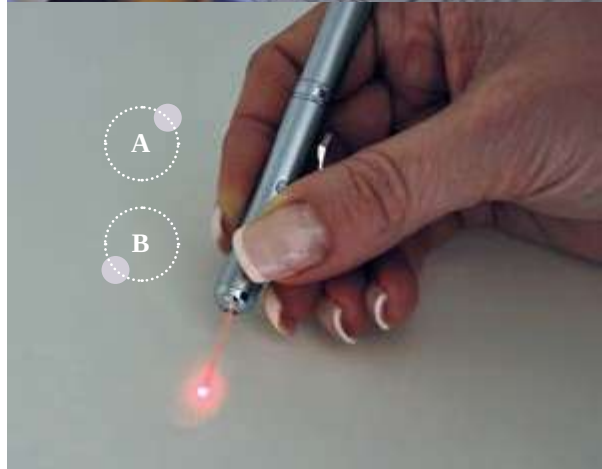

Ponteira laser e LED



B



Ebre — 91821



Esferográfica em metal. Com ponteira laser e LED. Incluso 3 pilhas LR41. Até 1,5 km de escrita. Fornecida em estojo com forro de veludo.



∅10 x 131 mm | Estojo: 170 x 50 x 20 mm

LSR – 35 x 5 mm



127



3 cores distintas



Lapiseira



Sketch — 91843



Esferográfica multifunções em metal com diferentes possibilidades de escrita: lapiseira com grafite 0,5 mm, escrita a vermelho, azul ou preto. Esferográfica até 2 km de escrita. Fornecida em estojo almofadado.



∅10 x 132 mm | Estojo: 150 x 43 x 24 mm

LSR – 50 x 5 mm



103



Mecanismo twist

A

B



112

A

112 167 137 106



Clare — 81156

Esferográfica em alumínio com mecanismo twist e clipe. Disponível em elegantes cores. Até 2 km de escrita.

∅10 x 140 mm

PDP = 50 x 6 mm



137

B

137 124 127 103



Lea — 51125

Esferográfica em alumínio com acabamento matt. Até 1,5 km de escrita.

∅10 x 137 mm

LSR = 50 x 6 mm



Ponteira touch e mecanismo twist



NEW



Julie — 81144

Esferográfica em metal com ponteira touch. Fornecida com estojo de oferta desmontado.

∅10 x 141 mm |
Estojo: 150 x 15 x 19 mm

LSR – 35 x 5 mm

Ponteira touch e mecanismo twist



Touch — 51437

Roller em metal com corpo brilhante e detalhes em cromado. O detalhe da ponteira touch torna este brinde sofisticado e adaptável às novas tecnologias. Escrita preta. Fornecido com estojo presente desmontado.

∅9 x 141 mm |
Estojo: 150 x 15 x 19 mm

LSR – 40 x 5 mm

Ponteira touch



Wass Touch — 81005

Esferográfica em alumínio com mecanismo twist com ponteira touch em silicone. Até 2 km de escrita. Fornecida em caixa presente.

∅10 x 142 mm |
Caixa: 175 x 41 x 20 mm

LSR – 40 x 5 mm

Ponteiras Touch

Concebidas para quem adora o mundo digital, estas esferográficas ajudam-no a manter os seus ecrãs limpos e sem marcas.

Ponteira touch e mecanismo twist



Mecanismo twist



 **Script** — 91494
Esferográfica em alumínio com mecanismo twist, ponteira touch e clipe. Até 1,5 km de escrita.
∅ 11 x 135 mm
LSR – 60 x 5 mm

 **Sinatra** — 51837
Esferográfica em alumínio com mecanismo twist, ponteira touch e clipe. Até 2 km de escrita. Incluso embalagem de veludo.
∅ 11 x 138 mm | Embalagem de veludo: 160 x 30 mm
LSR – 25 x 5 mm



 **Shanghai** — 91476
Esferográfica em alumínio com ponteira touch. Até 2 km de escrita.
∅ 11 x 140 mm
LSR – 70 x 6 mm



 **Halos** — 91629
Esferográfica em alumínio com ponteira touch. Até 1,5 km de escrita.
∅ 9 x 138 mm
LSR – 60 x 5 mm



 Tratamento antibacteriano
ISO 22196



A

Mecanismo twist

NEW

 **Kaylum** — 91791

Esferográfica em alumínio com tratamento antibacteriano, segundo a certificação ISO22196. Mecanismo twist, clipe e ponteira touch.

∅ 7 x 132 mm

LSR — 45 x 5 mm



Mecanismo twist

 **Miro** — 91444

Esferográfica em alumínio com mecanismo twist, clipe e ponteira touch.

∅ 8 x 137 mm

LSR — 45 x 4 mm



Mecanismo twist

 **Zoe** — 91624

Esferográfica em alumínio com mecanismo twist, clipe e ponteira touch.

∅ 8 x 135 mm

LSR — 50 x 5 mm





106



 **Daney** — 81155
 Roller em alumínio com clipe.
 Escrita preta.
 ∓ Ø10 x 136 mm
 ⚡ PDP – 50 x 6 mm



147



 **Lyme** — 91338
 Esferográfica em alumínio.
 Até 1,5 km de escrita.
 ∓ Ø12 x 138 mm
 ⚡ LSR – 40 x 7 mm



127



103

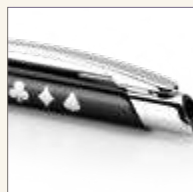

 **Serrat** — 91392
 Esferográfica em alumínio.
 Até 1,5 km de escrita.
 ∓ Ø9 x 140 mm
 ⚡ LSR – 90 x 5 mm



127



147



103

 **Edge** — 81126
 Esferográfica em alumínio com clipe flexível.
 Até 1,5 km de escrita.
 ∓ Ø10 x 147 mm
 ⚡ LSR – 60 x 6 mm

Mecanismo
twist



Wass — 81000

Esferográfica em alumínio com mecanismo twist, clipe em ferro com cromagem brilhante. Até 2 km de escrita. Fornecida em caixa presente.

∅10 x 138 mm | Caixa: 175 x 41 x 20 mm

LSR - 40 x 5 mm



Mecanismo
twist

Lesley Metallic — 81185

Esferográfica em metal com clipe.

∅7 x 129 mm

LSR - 40 x 4 mm





104

A

104 106 103

Lando Roller — 81191

Roller em alumínio com clipe.
Escrita azul.

∅ 11 x 140 mm
LSR – 45 x 7 mm

Mecanismo twist

106

106 103 104

Lando — 81190

Esferográfica em alumínio com mecanismo twist e clipe.

∅ 11 x 140 mm
LSR – 35 x 6 mm

127

127 106 103 104

Avila — 91492

Esferográfica em alumínio com clipe de metal.
Até 1,5 km de escrita.

∅ 9 x 139 mm
LSR – 60 x 5 mm



Alps — 91333

Esferográfica em alumínio até 2 km de escrita.
Incluso embalagem de veludo.

∅ 11 x 136 mm |
Embalagem de veludo: 160 x 30 mm
LSR - 60 x 5 mm



Mare — 91434

Esferográfica em alumínio.
Até 1,5 km de escrita.

∅ 10 x 133 mm
LSR - 70 x 7 mm



Dante — 91491

Esferográfica em alumínio com clipe de metal e grip.
Até 1,5 km de escrita.

∅ 10 x 136 mm
LSR - 50 x 5 mm





A



Joan — 91694

Esferográfica em alumínio com acabamento mate e botão com acabamento brilhante. Corpo com duplo acabamento.

∅ 10 x 140 mm

LSR – 70 x 6 mm

Efeito laser colorido

Grave a laser e combine sua criatividade com a cor do botão! Combinações que valorizam sua marca!



A

Gravação a laser mostra a cor do botão



Inky — 91847

Esferográfica em alumínio. Até 1,5 km de escrita.

∅ 11 x 139 mm

LSR – 65 x 5 mm



Acabamento emborrachado



Olaf Soft — 81192

Esferográfica em alumínio com acabamento emborrachado e clipe.

∅10 x 137 mm

LSR - 55 x 6 mm



Acabamento emborrachado



Poppins — 51140

Esferográfica em alumínio com corpo colorido e acabamento emborrachado. Até 1,5 km de escrita.

∅10 x 137 mm

LSR - 50 x 5 mm



Acabamento emborrachado



Beta Soft — 81141

Esferográfica em alumínio e acabamento emborrachado. Até 1,5 km de escrita.

∅10 x 137 mm

LSR - 55 x 6 mm

Torne a sua oferta ainda mais especial

A experiência de receber um presente é mais marcante se existir um momento de expectativa e curiosidade. Reforce a ligação à sua marca e demonstre toda a sua dedicação!



Lello — 91973

Estojo em cartão para 1 esferográfica.
Fornecido desmontado.

☒ 150 x 15 x 19 mm

✂ SCR – 120 x 10 mm



Vila — 91960

Embalagem em veludo para 1 esferográfica.
Esferográfica não inclusa.

☒ 160 x 30 mm

✂ TRS – 90 x 15 mm



Abe — 91968

Embalagem em cartão para 1 esferográfica.

☒ 155 x 40 mm

✂ SCR – 120 x 25 mm

Speare — 91969

Estojo em cartão para 1 esferográfica. Interior com elegante almofada em veludo.

☒ 170 x 50 x 28 mm

🔪 SCR - 140 x 35 mm



Casie — 91955

Estojo em cartão para 1 esferográfica. Interior com elegante almofada em veludo.

☒ 175 x 55 x 25 mm

🔪 SCR - 140 x 40 mm

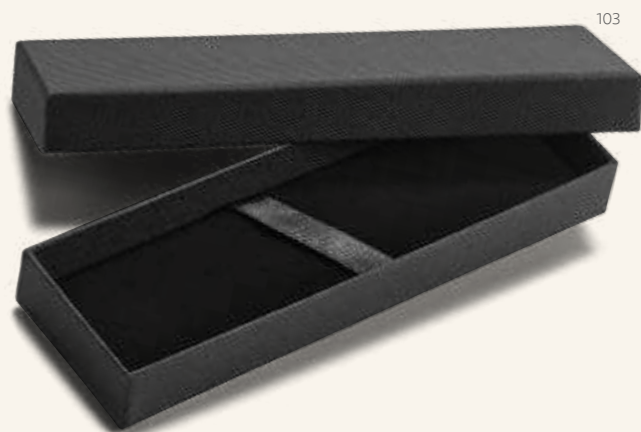

Pendulo — 91970

Estojo em papel craft para 1 esferográfica.

☒ 180 x 43 x 22 mm

🔪 SCR - 150 x 25 mm





A

B



A

ECologic



Cork — 81401



Esferográfica em cortiça e metal inspirada no sobreiro com mecanismo twist e clipe. Até 1,5 km de escrita. Fornecida em estojo almofadado com detalhe em cortiça.

∅11 x 137 mm | Estojo: 180 x 56 x 30 mm

LSR - 40 x 6 mm



Lavre — 93324

.232



B

ECologic



Natura — 91647



Esferográfica em cortiça e alumínio com clipe. Até 1,5 km de escrita. Fornecida com embalagem presente em cartão.

∅9 x 139 mm | Bolsa: 155 x 40 mm

LSR - 85 x 5 mm

Ajudar o ambiente, uma esferográfica de cada vez

A nossa gama de esferográficas ECOlogic apresenta uma grande variedade de materiais sustentáveis, combinando o respeito pelo ambiente com a funcionalidade.

• Clipe de grandes dimensões para personalização

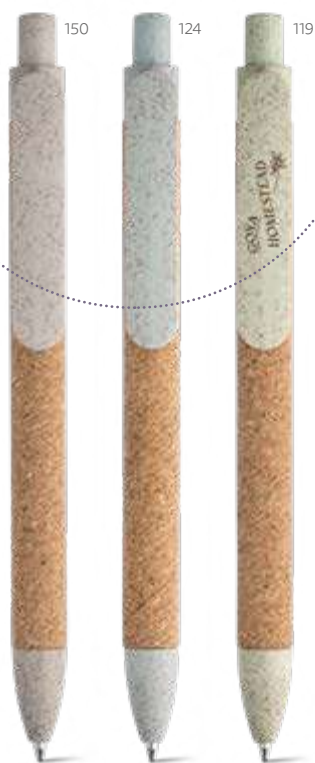

C

NEW

ECOlogic

 **Goya** — 91795

 Esferográfica em cortiça com clipe e elementos coloridos em fibra de trigo e PP.

∅ 11 x 140 mm

LSR - 85 x 5 mm





Bambu e fibra de palha de trigo

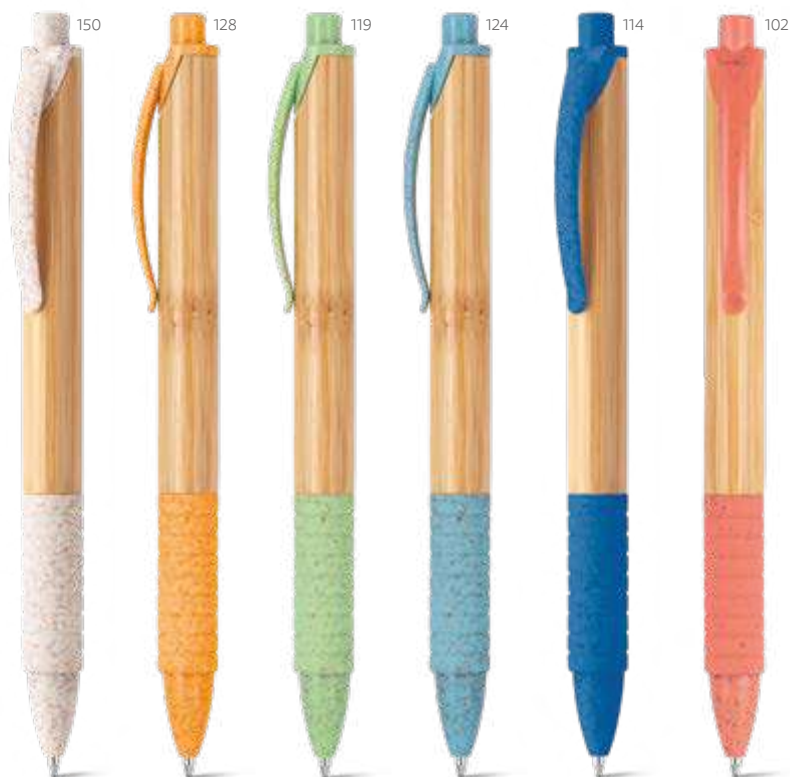

Ecologic



Kuma — 81013



Esferográfica em bambu com clipe, antideslizante e elementos coloridos em fibra de trigo e ABS. Até 1,5 km de escrita.

∅ 11 x 142 mm

PDP – 50 x 6 mm

Conjugué a durabilidade do bambu com uma escrita sustentável



A

A

NEW

ECÓlogic

 **Bahia** — 91820

 Esferográfica em bambu com mecanismo twist e clipe em metal. Fornecida em estojo de bambu. Esferográfica amiga do ambiente.

∓ Ø11 x 140 mm | Estojo: 170 x 40 x 25 mm

✂ LSR – 35 x 6 mm



160



160

ECÓlogic

 **Elliot** — 81009

 Esferográfica em bambu com clipe de metal. Até 1,5 km de escrita.

∓ Ø11 x 137 mm

✂ PDP – 50 x 6 mm



160

ECÓlogic

 **Nicole** — 81010

 Esferográfica em bambu com clipe de metal. Até 1,5 km de escrita.

∓ Ø13 x 143 mm

✂ PDP – 35 x 6 mm



160

ECÓlogic

 **Beta Bamboo** — 81011

 Esferográfica em bambu com clipe de metal. Até 1,5 km de escrita.

∓ Ø11 x 141 mm

✂ PDP – 50 x 6 mm



160



ECÓlogic



Greeny — 81162



Conjunto de esferográfica e lapiseira em bambu. Esferográfica até 1,5 km de escrita. Lapiseira com grafite 0.7. Fornecida em estojo de cartão.



∅ 11 x 138 mm | Estojo: 171 x 53 x 23 mm

SCR – 60 x 20 mm



160



ECÓlogic



Hera — 81163



Esferográfica em bambu com clipe em metal. Até 1,5 km de escrita.

∅ 11 x 138 mm

PDP – 50 x 7 mm



108 119 114 128 150 103



ECÓlogic

 **Benjamin** — 81012

 Esferográfica em bambu com ponteira touch e clipe em metal. Os elementos coloridos são em fibra de trigo e ABS. Até 1,5 km de escrita.

∅11 x 139 mm

➤ PDP – 60 x 6 mm



114 119 105 150 103



ECÓlogic

 **Volter** — 81014

 Esferográfica em bambu e clipe em metal. Os elementos coloridos são em fibra de trigo e ABS. Até 1,5 km de escrita.

∅11 x 142 mm

➤ PDP – 60 x 6 mm





Slow down and enjoy
the simple pleasures in life



A



103

A

ECologic



Leaf — 91846

Conjunto de esferográfica e lapiseira em papel craft com clipe e ponteira de plástico. A lapiseira é de 0.5 mm. Fornecido com uma bolsa em cartão.

∅10 x 138 mm | Bolsa: 175 x 55 mm

PDP – 50 x 5 mm



160

ECologic



Masai — 91383

Esferográfica em papel craft com clipe de plástico. Até 1,5 km de escrita.

∅10 x 140 mm

PDP – 50 x 7 mm



160

ecologic

 **Bambu** — 91378

 Esferográfica em bambu com clipe de plástico.

∅11 x 142 mm

LSR – 80 x 6 mm



103



106



109

NEW

ecologic

 **Pati** — 81153

 Esferográfica em bambu com antideslizante e com clipe e ponteira de plástico.

∅11 x 142 mm

PDP – 50 x 7 mm



Interior em papel de jornal reciclado

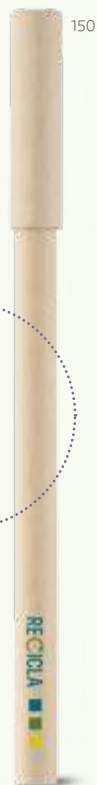

150

NEW

ecologic

 **Recicla** — 91290

 Esferográfica com tampa em papel craft e interior em papel de jornal reciclado. Esferográfica amiga do ambiente.

∅6 x 145 mm

PDP – 60 x 5 mm

NEW

ecologic

 **Bio** — 91291

 Esferográfica em madeira com tampa transparente. Esferográfica amiga do ambiente.

∅10 x 150 mm

PDP – 60 x 6 mm



150



**Design inovador e arrojado
com o selo de qualidade
Made in Italy**

Writing instruments
since 1970

**Todas as esferográficas
com pelos menos
1.500m de escrita
e tinta dokumental®.**



Evo

A leveza das suas linhas e as cores sóbrias em que se apresentam transmitem uma confiança ímpar. Protagonistas ilustres em qualquer espaço, vão fazer incidir na sua marca elegância e prestígio.



Evo Mm — 31013

Esferográfica com acabamento metalizado e ponteira de metal. Tinta Dokumental® até 2,5 km de escrita.

∅ 9 x 140 mm

✎ PDP – 50 x 5 mm



• Acabamento metalizado



 **Wave Mm** — 31010

Esferográfica com acabamento metalizado e tinta Dokumental® até 2 km de escrita.

∅ 9 x 140 mm

 PDP - 50 x 5 mm



• Acabamento brilhante



 **Wave Cc** — 31011

Esferográfica com acabamento brilhante e tinta Dokumental® até 2 km de escrita.

∅ 9 x 140 mm

 PDP - 50 x 5 mm

• Acabamento frost



 **Wave Frost** — 31012

Esferográfica com acabamento frost e tinta Dokumental® até 2 km de escrita.

∅ 9 x 140 mm

 PDP - 50 x 5 mm



Esferográficas produzidas a partir de ABS 100% reciclado

ECOlogic

Tilt Eco — 31020

Esferográfica reciclada eco com acabamento matt e tinta Dokumental® até 2 km de escrita.

∅10 x 135 mm

PDP – 40 x 6 mm

ECOlogic

New Star Eco — 31022

Esferográfica reciclada eco com acabamento matt e tinta Dokumental® até 2 km de escrita.

∅10 x 140 mm

PDP – 45 x 5 mm



Tilt Bc — 31018

Esferográfica com acabamento brilhante, ponteira colorida e tinta Dokumental® até 2 km de escrita.

∅10 x 135 mm

PDP – 40 x 6 mm

Ponteira frost colorida



Tilt Bt — 31019

Esferográfica com acabamento brilhante, ponteira frost colorida e tinta Dokumental® até 2 km de escrita.

∅10 x 135 mm

PDP – 40 x 6 mm

• Top Pen •

**Design e diversidade
que marcam a diferença.**

Ideais para grandes campanhas.

As esferográficas Top Pen conjugam um design moderno e cores arrojadas com uma ótima relação qualidade-preço. Todos os nossos modelos são ergonômicos, proporcionando uma escrita suave e confortável.

Com as generosas áreas de personalização destas esferográficas, a sua marca tem tudo o que precisa para brilhar!

**Todas as esferográficas com pelo menos
1.200m de escrita.**





Ross — 81106

Esferográfica em ABS com acabamento brilhante.
Ponteira cromada e clipe de grande dimensão.
Até 1,5 km de escrita.

∅12 x 142 mm

▀ SRC – 40 x 25 mm



A

104 102 105 128 108 119 109 124 103



Caribe — 51256

Esferográfica em ABS com grip, acabamento brilhante e ponteira cromada. Até 1,5 km de escrita.

∅10 x 138 mm

PDP - 40 x 6 mm



B

124 104 128 105 109 103



Caribe White — 81104

Esferográfica em ABS com grip e acabamento brilhante. Ponteira cromada. Até 1,5 km de escrita.

∅11 x 140 mm

PDP - 40 x 6 mm



Acabamento translúcido e mecanismo twist



119 104 132 105 103



 **Sally Frost** — 81108

Esferográfica em ABS com acabamento translúcido e mecanismo twist. Até 1,5 km de escrita.

∅10 x 136 mm

SRC – 40 x 23 mm

109 124 104 105 128 103



 **Dara** — 81100

Esferográfica em ABS com acabamento brilhante. Até 1,5 km de escrita.

∅9 x 140 mm

SRC – 45 x 20 mm



Acabamento brilhante e mecanismo twist

124 104 105 108 119 106 103





 **Sally** — 81107

Esferográfica em ABS com acabamento brilhante e mecanismo twist. Até 1,5 km de escrita.

∅10 x 136 mm

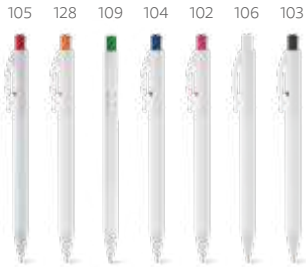
SRC – 40 x 23 mm



 **Lana White** — 81123
 Esferográfica em ABS com acabamento brilhante e mecanismo colorido.
 Até 1,5 km de escrita.
 ∅ 9 x 141 mm
 SRC – 45 x 15 mm



 **Lana** — 81122
 Esferográfica em ABS com acabamento brilhante.
 Até 1,5 km de escrita.
 ∅ 9 x 141 mm
 SRC – 45 x 15 mm



• Acabamento translúcido

 **Lana Frost** — 81124
 Esferográfica em ABS com acabamento translúcido.
 Até 1,5 km de escrita.
 ∅ 9 x 141 mm
 SRC – 45 x 15 mm



• **Corpo triangular**



Roy — 81121

Esferográfica em ABS com grip, acabamento brilhante e corpo triangular. Até 1,5 km de escrita.

∅ 9 x 141 mm

➤ PDP – 60 x 5 mm

Esferográficas com tampa com acabamento à sua escolha: frost ou matt



Acabamento frost

Kate — 81116

Esferográfica em PP com acabamento frost. Até 1,5 km de escrita.

∅ 8 x 151 mm

▄ SRC - 45 x 15 mm



Acabamento frost

Amy — 81115

Esferográfica em PP com acabamento frost. Até 1,5 km de escrita.

∅ 8 x 151 mm

▄ SRC - 45 x 15 mm



Acabamento frost

Kate Bk — 81117

Esferográfica em PP com acabamento frost. Até 1,5 km de escrita.

∅ 8 x 151 mm

▄ SRC - 45 x 25 mm

Acabamento
frost

 **Milu Frost** — 81109

Esferográfica em PP
e acabamento frost.
Até 1,5 km de escrita.

∅10 x 142 mm

▀ SRC — 45 x 25 mm



Acabamento
matt

 **Milu** — 81113

Esferográfica em PP
com acabamento matt.
Até 1,5 km de escrita.

∅10 x 142 mm

▀ SRC — 45 x 25 mm



Esferográficas com tampa com acabamento brilhante



Marley — 81118

Esferográfica em PP com acabamento brilhante. Até 1,5 km de escrita.

∅ 8 x 151 mm

SRC - 45 x 15 mm



Jacky Bk — 81120

Esferográfica em PP com acabamento brilhante. Até 1,5 km de escrita.

∅ 8 x 151 mm

SRC - 45 x 15 mm



Jacky — 81119

Esferográfica em PP com acabamento brilhante.
Até 1,5 km de escrita.

∅ 8 x 151 mm

▸ SRC - 45 x 15 mm



Ateneo — 51736

Lápis com borracha.
Grau de dureza: HB.

∅ 7 x 190 mm

➤ PDP – 40 x 5 mm



Ernster — 51721

Lápis apontado com borracha.
Grau de dureza: HB.

∅ 7 x 190 mm

➤ PDP – 40 x 5 mm



Cornwell — 51716

Lápis apontado com borracha.
Grau de dureza: HB.

∅ 7 x 190 mm

➤ PDP – 40 x 5 mm



Barter — 51759

Mini lápis afiado com borracha.
Grau de dureza: HB.

∅ 7 x 100 mm

➤ PDP – 40 x 5 mm



Croco —
51746
P. 371



A



Rizzoli — 51738
Lápis apontado. Grau de dureza: HB.
∅ 8 x 175 mm
PDP - 40 x 5 mm



A

Rhombus — 51932
Kit de escrita composto por régua de 16,5 cm,
2 lápis de grafite, 1 borracha e 1 apontador.
Fornecido com bolsa em cartão.
∅ Bolsa: 190 x 45 x 20 mm
SCR - 170 x 30 mm



A



Aguza —
53621
📄 .375



Schooli —
93607
📄 .377



103



104



106



105



108



128



119



124

A

Siza — 51935
Borracha em TPR com capa protetora em PP.
⊥ 55 x 33 x 13 mm
🔪 PDP – 20 x 15 mm



106



103

Austen — 51917
Borracha branca em TPR.
⊥ 55 x 22 x 12 mm
🔪 SCR – 45 x 10 mm

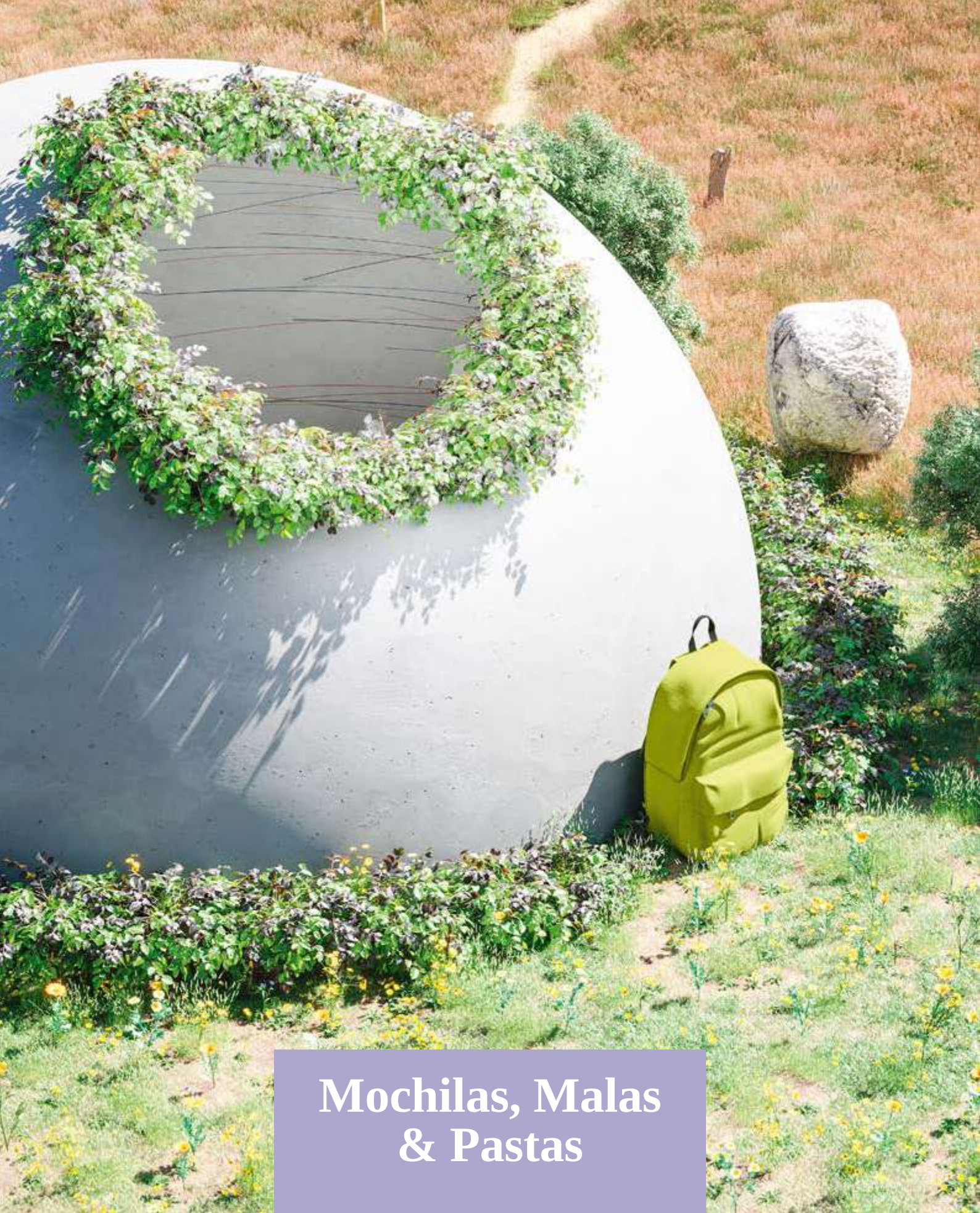

**Mochilas, Malas
& Pastas**



BRANVE®

O magnetismo das personalidades fortes e a capacidade de combinar consigo. De design cosmopolita e carácter vincado, a BRANVE® é contemporaneidade e inovação. Conforto, durabilidade e elegância aliadas à praticidade – para quem procura o luxo da funcionalidade em cada detalhe.

THE BRAND THAT MATCHES

Saiba mais online

branve.com

EUROPEAN
DESIGN

HIGH QUALITY
STANDARDS

Encontre outros produtos BRANVE®

 .20 Escritório

 .108 Escrita

DYNAMIC COLLECTION

Para os dinâmicos com mais estilo

Negócios e lazer podem andar de mãos dadas. Importa manter o ritmo frenético cosmopolita e o segredo é a multifuncionalidade. Ser versátil é saber conjugar o improvável – a robustez e a harmonia, a praticidade e a nobreza de materiais. Na Dynamic, os objetos multiplicam-se mas são, simultaneamente, unos: é energia em movimento.

Encontre o bloco de notas DYNAMIC 93597

 .25



15,6"

Dynamic Backpack I 92682

104



10,5"

A DYNAMIC Backpack é uma mochila urbana que se distingue pela sua versatilidade e dualidade. O seu design eficiente permite-lhe que seja um objeto único e versátil que se multiplica discretamente numa mochila e numa sacola de viagem. A mochila em c.sintético 1680D tem dois bolsos no interior, que permitem proteger seu notebook até 15.6" e seu tablet até 10.5". A espaçosa sacola de viagem permite organizar na perfeição sua roupa para uma viagem de 2 ou 3 dias. Possui bolso antirroubo na parte posterior e fechos com banda elástica com placa em PU. A DYNAMIC Backpack tem ainda um encaixe para trolley que sublinha o seu lado prático e funcional. As duas partes desta mochila, podem ser usadas separadamente ou como uma peça única. Fornecida em sacola de non-woven.

± 300 x 420 x 200 mm | Mochila: 300 x 420 x 75 mm |

Sacola de viagem: 300 x 420 x 130 mm |

Sacola em Non-woven: 550 x 580 x 210 mm

➤ LSR – 40 x 10 mm



Mochila 2 em 1



Compartimentos para portátil, tablet e outros objetos





Fecho inovador ideal para personalizar

Base resistente e duradoura

103

14"

Empire Backpack 92680

10,5"

A mochila EMPIRE é sofisticada e construída em c.sintético texturado de elevada qualidade. O compartimento principal é composto por 2 divisórias almofadadas, compatíveis com notebook até 14" e tablet até 10,5", e diversos bolsos que facilitam a arrumação. Na parte frontal, existe mais um bolso grande. Os fechos laterais têm imã resistente e placas metálicas ideais para personalização. A parte posterior, com sistema de apoio acolchoado para as costas e as alças totalmente almofadadas, garante máximo conforto e os cantos inferiores reforçados asseguram durabilidade. Contém bolsos interiores e fecho. A mochila EMPIRE tem banda para transporte em trolley, o que a torna num objeto versátil e prático tanto para o dia-a-dia como para viagens de negócios. Fornecida em sacola de non-woven.

☒ Mochila: 290 x 370 x 90 mm | Sacola de non-woven: 500 x 500 x 80 mm
☑ LSR - 15 x 15 mm



Fecho inovador ideal para personalizar



Base resistente e duradoura



Base resistente e duradoura



Várias possibilidades para transportar

A

B

15,6" **Empire Suitcase II**
92359

103



A EMPIRE II é uma pasta clássica e sofisticada, que contém dois bolsos idealizados para proteger o seu notebook até 15.6" e o seu tablet até 10.5". O seu design, tal como todos os produtos desta linha, foi pensado ao mais ínfimo pormenor e todos os detalhes fazem com que a pasta EMPIRE II seja o objeto ideal para o dia-a-dia, que não passa despercebido. O acabamento da EMPIRE II é em c.sintético texturado de alta qualidade. A versatilidade que se denota nas diferentes formas de transporte, é igualmente perceptível no seu encaixe para trolley. Fornecida em sacola de non-woven.

✂ EMPIRE SUITCASE II: 380 x 280 x 80 mm |
Sacola em non-woven: 500 x 500 x 80 mm
✂ LSR - 15 x 15 mm

14" **Empire Suitcase I**
92360

103



A EMPIRE I é uma pasta executiva moderna com toque de sofisticação, em polípele texturado de elevada qualidade. Possui um compartimento principal com 2 bolsos almofadados, que permitem guardar seu notebook até 14" e seu tablet até 10.5". As diferentes formas de transportar a pasta tornam-na um objeto versátil, algo que é reforçado pelo seu encaixe para trolley. O fecho inovador com imã que a EMPIRE I tem na lateral elevam a pasta a um objeto único. Todos os pormenores são focados tanto na sua funcionalidade como na sua estética e exemplo disso são os detalhes metálicos usados na alça, que além de assegurarem a qualidade da EMPIRE I, garantem a sua unicidade. Fornecida em sacola de non-woven.

✂ 370 x 270 x 80 mm | Sacola em non-woven: 530 x 500 x 80 mm
✂ LSR - 15 x 15 mm

DIVERSITY COLLECTION

A linha que se adapta à diversidade urbana

A rotina citadina exige flexibilidade. Assumindo um estilo alternativo e arrojado, a linha DIVERSITY está preparada para todas as peripécias do dia a dia, encarando-as com entusiasmo, leveza e a dose certa de sobriedade. Peças trendy para quem está sempre pronto para a mudança.



Material impermeável
e fechos protetores



104



133

14"

10,5"

Urban Backpack 92683

104

133



A URBAN é uma mochila versátil em soft shell de alta densidade e tarpaulin. Desenhada para guardar um notebook até 14" e tablet 10,5". A impermeabilidade da URBAN tornam-na um objeto único. A impermeabilidade surge, tanto no seu tecido, como no design do zíper que protege o interior da mochila. O bolso frontal é espaçoso e de acesso intuitivo e rápido. As alças ajustáveis e a pega de mão, contribuem para a versatilidade da mochila. Fornecida em sacola de non-woven.

‡ Mochila: 400 x 300 x 70 mm |
Sacola de non-woven: 530 x 500 x 80 mm
♣ TRS – 140 x 40 mm

MOTION COLLECTION



Bolso extra



Alças ajustáveis



Alças ajustáveis



15,6" **Motion Backpack**
92681

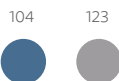

A MOTION é uma mochila com design irreverente e único em 600D e c.sintético de alta qualidade. A mochila tem diversos compartimentos, bolsos no seu interior e dois bolsos almofadados desenhados propositadamente para proteger um notebook de 15.6" e o tablet de 10.5". As alças e parte posterior almofadadas acentuam o conforto desta mochila. O encaixe para trolley é mais uma característica que enfatiza o lado prático desta mochila agilizando o seu transporte. O bolso frontal com pala e os bolsos laterais são igualmente únicos pelo seu desenho, desde a assimetria do bolso frontal ao escondido bolso na lateral que permite guardar uma garrafa de água. Fornecida em sacola de non-woven.

‡ MOTION BACKPACK: 410 x 330 x 150 mm |

Sacola em non-woven: 500 x 500 x 80 mm

♣ SCR – 40 x 10 mm

104 123 **Motion Bag**
92521

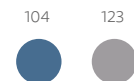

A MOTION BAG é uma sacola de viagem prática e elegante, em 600D catiónico e c.sintético de alta qualidade. O compartimento principal espaçoso é ideal para guardar roupa e outros utilitários necessários para viagens curtas. Possui ainda quatro bolsos no interior e bolso frontal com uma pala de desenho assimétrico, que caracteriza esta linha e lhe confere um design moderno. Fecha com ímã. A praticidade desta sacola é acompanhada por um design pormenorizado e cuidado que conduzem a detalhes como o espaço para colocar a etiqueta de nome, os pés metálicos que protegem a sacola, o desenho do fecho que permite ser controlado por cadeado (não incluso). As alças são desenhadas para serem ajustáveis e confortáveis. Fornecida em sacola de non-woven.

‡ 500 x 300 x 250 mm |

Sacola em non-woven: 700 x 450 x 75 mm

♣ SCR – 40 x 10 mm



A

Viaje em primeira classe

Malas modernas que garantem uma utilização prática, mantendo seus objetos pessoais em segurança.



NEW



Coimbra — 92090

15,6"

Mala de viagem executivo em ABS e 600D com 4 rodas duplas giratórias, interior forrado e pega extensível em alumínio com altura até 460 mm. Compartimento almofadado para notebook até 15,6" e 2 bolsos frontais. Contém fecho de segurança com senha na lateral. Com placa preta de personalização. Capacidade até 33 L e peso de 1,67Kg.

☒ 320 x 540 x 210 mm

☞ LSR – 35 x 15 mm

33 L

103

Placa para personalização



Placa para personalização



35 L

103



Uruguay — 92140

17"

Mala de viagem executivo em ABS com compartimento frontal para notebook 17" e interior forrado. 4 rodas giratórias, pega extensível em alumínio, com mola (altura da pega estendida até 480 mm) e placa metálica removível, para fácil gravação. Mala com capacidade até 35 L e peso de 2,70 kg.

☒ 340 x 545 x 245 mm | Placa: 31 x 31 mm

☞ LSR – 23 x 23 mm



Placa para personalização



31 L

103



Vigo — 92144

Mala de viagem executivo em ABS com interior forrado, com divisória. Fecho de segurança com senha na lateral, 4 rodas giratórias, pega extensível em alumínio, com mola (altura da pega estendida até 500 mm), e placa metálica removível com imã, para fácil gravação. Mala com capacidade até 31 L e peso de 2,25 kg.

☒ 355 x 550 x 200 mm | Placa: 50 x 20 mm

☞ LSR – 37 x 12 mm

33 L



104



103



Perth — 92160

Mala de viagem executivo em ABS e PC com interior forrado, com divisória. Fecho de segurança com senha na lateral, 4 rodas duplas giratórias e pega extensível em alumínio, com mola (altura pega estendida até 510 mm). A mala tem capacidade até 33 L e peso de 2,70 kg.

↕ 335 x 550 x 230 mm

↗ TXP – 160 x 100 mm

34 L



104



103



Placa para personalização



Fecho de segurança



Rodas duplas giratórias

A

Hamburg — 92185

Mala de viagem executiva em ABS com divisória e interior forrado. Fecho de segurança com senha na lateral, 4 rodas duplas giratórias e pega extensível em metal (altura até 530 mm), com mola e placa metálica removível, para fácil gravação. Capacidade até 34 L e peso de 2,50 kg.

↕ 345 x 540 x 220 mm | Placa: 60 x 20 mm

↗ LSR – 30 x 5 mm



A



B



Placa para personalização



127



103



B

33 L

127



 **Bruges 33L** — 92159

Mala de viagem executivo em ABS e PET com interior forrado, com divisória. Fecho de segurança com senha na lateral, 4 rodas duplas giratórias, pega extensível em alumínio, com mola (altura pega estendida até 530 mm) e placa metálica removível, para fácil gravação. Mala com capacidade até 33 L e peso de 2,70 kg.

▮ 335 x 540 x 225 mm | Placa: 60 x 30 mm

➤ LSR – 50 x 22 mm

XXL

90 L

103



Placa para personalização



 **Bruges 90L** — 92297

Mala de viagem executivo em ABS e PET com interior forrado, com divisória. Fecho de segurança com senha na lateral, 4 rodas duplas giratórias, pega extensível em alumínio, com mola (altura pega estendida: 335 mm) e placa metálica removível, para fácil gravação. A mala tem capacidade de 90 L e peso de 4,20 kg.

▮ 500 x 775 x 290 mm | Placa: 60 x 30 mm

➤ LSR – 50 x 22 mm

37 L

127

127

103



Placa para personalização



A



Buenos Aires — 92186

Mala de viagem executivo em ABS com interior forrado, com divisória. Fecho de segurança com senha na lateral, 4 rodas duplas giratórias, pega extensível em metal, com mola (altura pega estendida até 520 mm) e placa metálica removível, para fácil gravação. A mala tem capacidade até 37 L e peso de 2,50 kg.

☒ 355 x 555 x 225 mm | Placa: 29 x 29 mm

🔪 LSR – 25 x 10 mm



A

20 L

103



Placa para personalização



Moura — 92129

15,6"

Mala de viagem para notebook em c. sintético e 1680D com caixa rígida e 2 rodas. Compartimento interior forrado e almofadado para notebook portátil até 15.6". Etiqueta para identificação na parte posterior. Pega extensível em alumínio, com mola (altura da pega estendida até 675 mm) e placa metálica removível com imã, para fácil gravação. Mala com capacidade até 20 L e peso de 2,75 kg.

☒ 430 x 370 x 180 mm | Placa: 50 x 20 mm

🔪 LSR – 37 x 12 mm

123



Kathrine — 92125

Mala de cosméticos em 600D e EVA com fecho duplo. Compartimento frontal semi-rígido e interior forrado com 2 bolsos. A mala tem uma banda para transporte em trolley de viagem e alça ajustável em webbing.

☒ 305 x 250 x 85 mm

🔪 TRS – 150 x 100 mm

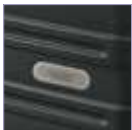

Placa para personalização



Phuket — 92138

Mala de viagem executivo em ABS com interior forrado, com divisória. Fecho de segurança com senha na lateral, 4 rodas giratórias, pega extensível em alumínio, com mola (altura da pega estendida até 435 mm) e placa metálica removível, para fácil gravação. Mala com capacidade até 36 L e peso de 2,80 kg.

▮ 370 x 570 x 220 mm | Placa: 60 x 15 mm

↗ LSR - 48 x 9 mm

Mochilas com trolley



Placa para personalização

A



Parte posterior e alças almofadadas



Pega extensível em metal



Base reforçada



A

Eindhoven — 92145

Mochila trolley para notebook em 600D de alta densidade e poliéster 600D impermeável. Compartimento principal para notebook até 15.6". Bolso frontal com zíper e bolsos laterais com tela. Mochila trolley com protetor de rodas e pega extensível em metal. Parte posterior e alças almofadadas. Incluso placa metálica removível com imã, para fácil gravação.

340 x 430 x 170 mm

TR5 — 80 x 120 mm



15,6"



103



Placa para personalização



Protetor de rodas



113



Alças reforçadas e almofadadas



Protetor de rodas

Note — 92283

Mochila trolley para notebook em 1680D e 300D com 2 rodas. Compartimento principal almofadado para notebook 15.6". Segundo compartimento forrado e com diversos bolsos. Bolso frontal com zíper e bolsos laterais com tela. O trolley tem protetor de rodas, alças almofadadas e pega extensível em metal, com mola (altura da pega estendida até 530 mm). Placa metálica removível com imã, para fácil gravação. Capacidade até 24 L e peso de 1,65 kg.

350 x 460 x 155 mm | Placa: 50 x 20 mm

LSR — 25 x 8 mm



15,6"

Cardiff — 92183

Mochila trolley para notebook em 300D com 2 rodas duplas. Compartimento principal forrado e almofadado, com divisória para notebook até 15.6". A trolley tem 2 bolsos laterais em tela, protetor de rodas, alças almofadadas e pega extensível em alumínio, com mola (altura da pega estendida: 550 mm). Capacidade até 17 L e peso de 1,10 kg.

310 x 430 x 140 mm

TR5 — 130 x 140 mm



15,6"



Estrutura removível com pega extensível



Protetor de rodas



Alças reforçadas e almofadadas



Placa para personalização



Miami — 92293

Mochila trolley para notebook em Nylon 999 impermeável com 2 rodas. Compartimento principal almofadado para notebook até 17". Segundo compartimento forrado e com diversos bolsos. Bolso frontal com zíper e bolsos laterais com tela. O trolley tem protetor de rodas, estrutura removível, parte posterior e alças almofadadas e pega extensível em alumínio, com mola (altura da pega estendida até 550 mm). Placa metálica removível com imã, para fácil gravação. Capacidade até 30 L e peso de 1,70 kg.



350 x 460 x 225 mm | Placa: 50 x 20 mm

LSR – 37 x 12 mm



Placa para personalização



Avenir — 92177

Mochila trolley para notebook em 1680D e 300D com 2 rodas. Compartimento principal forrado e almofadado, com divisória almofadada para notebook até 17". 2 bolsos frontais e 2 bolsos laterais com zíper. O trolley tem protetor de rodas e alças almofadadas. Pega extensível em metal, com mola (altura da pega estendida: 550 mm). Placa metálica removível com imã, para fácil gravação. Capacidade até 22 L e peso 1,80 kg.

330 x 490 x 220 mm | Placa: 50 x 20 mm

LSR – 40 x 10 mm





NEW

Repurpose Backpack — 92080

Mochila para notebook em rPET 600D com alças almofadadas. O compartimento principal tem 2 divisórias almofadadas para notebook até 15.6" e tablet até 10.5". Contém dois bolsos com fecho na parte frontal e um bolso lateral em rede com elástico. Parte posterior almofadada com banda para transporte em trolley.



15,6"



10,5"

300 x 420 x 110 mm
TRS – 140 x 60 mm



Repurpose Cooler — 98427

.310



Repurpose Bag — 92078

.205



NEW

Repurpose Sports — 92079

Bolsa esportiva em rPET 600D com interior forrado e fundo com placa semi-rígida. Compartimento principal e bolso frontal com fecho e dois bolsos laterais, um em rede e outro com fecho. A bolsa tem alça de ombro removível e ajustável em webbing com reforço almofadado.

500 x 300 x 230 mm
TRS – 280 x 50 mm



Repurpose Collection

A coleção que dá uma nova vida aos resíduos plásticos, transformando-os em produtos de qualidade e práticos.

A



C



B



Odin —
94603
♻️ .331





104

Material impermeável



Porta USB com cabo USB e micro USB



Placa para personalização



104

133

103



Spacio — 52675

17"

Mochila para notebook em Nylon 2Tone impermeável com dois compartimentos forrados. O compartimento posterior tem bolso interior com zíper e divisória almofadada para notebook até 17". O compartimento frontal tem diversos bolsos interiores. Mochila com 2 bolsos frontais e 2 bolsos laterais com porta USB e cabo USB / micro USB para ligar a dispositivos móveis (bateria portátil não inclusa). Parte posterior almofadada, com sistema de apoio acolchoado para as costas e alças almofadadas. Placa metálica removível com imã, para fácil gravação.

310 x 470 x 200 mm |

Placa: 50 x 20 mm

LSR – 40 x 12 mm



133

Material impermeável



Boston — 92675

17"

Mochila para notebook em Nylon 2Tone impermeável com 2 compartimentos. Compartimento posterior forrado, com bolso interior com zíper e divisória almofadada para notebook até 17". Compartimento frontal forrado, com diversos bolsos interiores. A mochila tem 2 bolsos frontais e 2 bolsos laterais. Porta USB e cabo USB / micro USB para ligar a dispositivos móveis (bateria portátil não inclusa). Parte posterior almofadada, com sistema de apoio acolchoado para as costas e alças almofadadas.

310 x 470 x 200 mm

TRS – 150 x 100 mm



NEW



Brooklyn — 92081

Mochila para notebook em Nylon 2Tone impermeável com 2 compartimentos e alças almofadadas. O compartimento posterior tem 2 divisórias almofadadas com fecho em velcro para notebook até 17" e tablet até 10.5". Compartimento frontal com diversos bolsos interiores. Contém dois bolsos na parte frontal, tendo um deles bloqueio RFID. Nas laterais existe um bolso para garrafas em elastano e outro para o guarda chuva, com ilhós perfurados para evitar acumulação de água. A parte posterior almofadada tem um bolso oculto e uma banda para transporte em trolley.

17"

10.5"

320 x 450 x 140 mm

TR5 - 150 x 50 mm



123

Material impermeável



Placa para personalização

NEW



Fortaleza — 52081

Mochila para notebook em Nylon 2Tone impermeável com 2 compartimentos e alças almofadadas. O compartimento posterior tem 2 divisórias almofadadas com fecho em velcro para notebook até 17" e tablet até 10.5". Compartimento frontal com diversos bolsos interiores. Contém dois bolsos na parte frontal, tendo um deles bloqueio RFID. Nas laterais existe um bolso para garrafas em elastano e outro para o guarda chuva, com ilhós perfurados para evitar acumulação de água. A parte de trás almofadada tem bolso oculto e banda para transporte em trolley. Placa metálica removível com imã, para fácil gravação.

17"

10.5"

320 x 450 x 140 mm

LSR - 35 x 15 mm



123

2 bolsos frontais



Alça para transporte em trolley



Bolso oculto nas costas com zipper



Entrada USB e Jack 3,5mm

2 bolsos laterais com zíper



NEW

17" **Lyon** — 92320

Mochila para notebook em 900D e Tarpaulin com 2 compartimentos principais com diversos bolsos interiores. Um completamente forrado e acolchoado para computador de grandes dimensões até 17". A mochila tem ainda 2 bolsos frontais, 2 bolsos laterais com zipper e bolso oculto nas costas com zipper. Contém ainda tira de transporte para trolley e entradas USB e Jack 3,5mm. Parte posterior e alças são almofadadas.

330 x 480 x 180 mm

TRS – 100 x 160 mm



2 bolsos frontais



Entrada USB e Jack 3,5mm



Alça para transporte em trolley



Bolso lateral

1 Bolso forrado para notebook

NEW

15,6" **Verona** — 92089

Mochila para notebook em 900D com um compartimento principal com bolso forrado para notebook 15,6" e diversos bolsos interiores. Contém ainda 2 bolsos frontais, 1 lateral e entrada USB. Parte posterior e alças são almofadadas.

310 x 440 x 110 mm

TRS – 140 x 160 mm





Alça para transporte em trolley

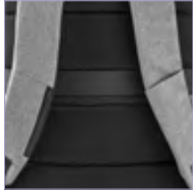

2 Bolsos nas alças, um com zipper



Bolso oculto nas costas com zipper



Entrada USB



Placa para personalização



123

133



Bolso no topo com zíper e bolso lateral



123

NEW

MunIQUE — 92322

Mochila para notebook em 300D com placa de metal preta personalizável e 2 compartimentos principais. Os 2 bolsos almofadados são compatíveis com computador até 17" e com um tablet de 9,7". Tem ainda mais 2 bolsos nas alças (1 com zipper), bolso oculto nas costas da mochila com zipper, bolso no topo com zipper e bolso aberto na lateral com entrada USB. Contém ainda tira de transporte para trolley e alças e parte posterior almofadadas.

17"

9,7"

310 x 480 x 130 mm

TRS – 200 x 50 mm





15,6" **Zippers Plate** — 52280

10,5" Mochila para notebook em 840D jacquard com dois compartimentos forrados. O compartimento posterior tem duas divisórias almofadadas para notebook até 15.6" e tablet 10.5". O compartimento frontal tem diversos bolsos interiores. Mochila com 3 bolsos frontais e 2 bolsos laterais, parte posterior almofadada, com sistema de apoio acolchoado para as costas e alças almofadadas. Placa metálica removível com imã, para fácil gravação.
 320 x 450 x 190 mm | Placa: 50 x 20 mm
 LSR – 40 x 12 mm

15,6" **Zippers Back** — 92280

10,5" Mochila para notebook em 840D jacquard e 300D com 2 compartimentos. Compartimento posterior forrado e almofadado, com 2 divisórias almofadadas para notebook até 15.6" e tablet 10.5". Compartimento frontal forrado, com diversos bolsos interiores. A mochila tem 3 bolsos frontais e 2 bolsos laterais. Parte posterior almofadada, com sistema de apoio acolchoado para as costas e alças almofadadas.
 320 x 450 x 190 mm
 TRS – 140 x 25 mm



15,6" **Tupi** — 92167

Compartimento principal com divisória almofadada para notebook até 15.6". Interior forrado. Mochila com 3 bolsos frontais e 2 bolsos laterais, parte posterior almofadada, com sistema de apoio acolchoado para as costas e alças almofadadas. Placa metálica removível com imã, para fácil gravação.
 330 x 480 x 180 mm | Placa: 50 x 20 mm
 LSR – 37 x 12 mm



Zippers Sport — 92516

Bolsa esportiva executivo em 840D jacquard e 300D e interior forrado. Contém bolsos frontais, fundo com placa semi-rígida e alça de ombro ajustável com reforço almofadado.
 520 x 300 x 220 mm
 TRS – 140 x 50 mm



133

17" **Arky** — 92166

Mochila para notebook em 600D de alta densidade com compartimento forrado, com divisória almofadada para notebook até 17" e diversos bolsos interiores. 2 bolsos laterais em tela e 2 bolsos frontais. Parte posterior almofadada, com sistema de apoio acolchoado para as costas e alças almofadadas. Placa metálica removível com imã, para fácil gravação.

340 x 450 x 175 mm | Placa: 50 x 20 mm

LSR – 37 x 12 mm



103

NEW

15,6" **Angle Bpack** — 92270

Mochila para notebook em c.sintético. Compartimento com divisória almofadada para notebook até 15.6". Interior forrado e almofadado. Contém diversos bolsos interiores. A mochila tem 2 bolsos frontais e uma placa personalizável. A parte posterior é almofadada e tem sistema de apoio acolchoado para as costas e alças almofadadas.

340 x 450 x 130 mm | Placa: 40 x 20 mm

LSR – 30 x 15 mm

Sistema anti-roubo

Zíper oculto para maior segurança



Zíper de acesso escondido



113

Aveiro — 92176

Mochila para notebook em 900D de alta densidade e tarpaulin. Sistema antirroubo: compartimento principal com zíper oculto e parte posterior com 2 bolsos ocultos com zíper, para maior segurança. Compartimento principal forrado e almofadado, com 2 divisórias almofadadas para notebook até 15.6" e tablet 10.5". Diversos bolsos interiores, incluindo bolso almofadado para smartphone. Presilhas para organização de cabos no interior. Bolso lateral exterior com zíper, com acesso a bolso interior ideal para bateria portátil, facilitando o carregamento de diversos dispositivos. Parte posterior almofadada e sistema de apoio acolchoado para as costas. Alças almofadadas, com 1 bolso com zíper.

320 x 440 x 200 mm

TRS – 150 x 200 mm

Bolso exterior lateral para fácil carregamento de equipamentos eletrônicos



104



104



123

A

Traveller — 92674

Mochila para notebook em 600D de alta densidade e tarpaulin com 2 compartimentos. Compartimento posterior forrado, com diversos bolsos interiores e 2 divisórias almofadadas para notebook até 17" e tablet 10.5". Compartimento frontal forrado, ideal para transporte de roupa (ou para lazer). A mochila tem bolso frontal e a parte posterior e alças são almofadadas.

17"

10.5"

300 x 430 x 150 mm

TR5 - 150 x 100 mm



A



111



111



133

B

Adventure — 92174

Mochila para computador em algodão canvas pré-lavado. Compartimento principal forrado, com 2 divisórias almofadadas para computador até 15.6" e tablet até 10.5". A mochila tem bolso frontal e 2 bolsos laterais. Parte posterior e alças são almofadadas. Contém alça para transporte em trolley e placa em c. sintético para personalização.

15.6"

10.5"

300 x 420 x 120 mm | Placa: 60 x 30 mm

TR5 - 45 x 15 mm



B



Entrada USB e Jack 3,5mm



Alça para transporte em trolley



Bolso lateral



2 bolsos forrados para notebook

C

Uplus Carrers



113

C

NEW

Wellington — 92087

15,6"

10,5"

Mochila para notebook em 300D com 1 compartimento principal com 2 bolsos forrados para computador 15,6" e tablet 10,5 e diversos bolsos interiores. Contém ainda bolso frontal, bolso lateral e entradas USB e Jack 3,5mm. Parte posterior e alças são almofadadas.

320 x 410 x 120 mm

TR3 - 180 x 180 mm



Placa para personalização



113

NEW

Haia — 52087

15,6"

10,5"

Mochila para notebook em 300D com placa de personalização. Tem 1 compartimento principal com 2 bolsos forrados para notebook até 15,6" e tablet 10,5" e diversos bolsos interiores. Contém ainda bolso frontal, lateral e entradas USB e Jack 3,5 mm. Parte posterior e alças são almofadadas.

320 x 410 x 120 mm

LSR - 35 x 15 mm



123



14" **Kardon** — 52627

Mochila para notebook até 14" em poliéster 600D. Compartimento principal forrado, com bolso interior e compartimento almofadado próprio para o computador. A mochila tem 2 bolsos frontais com fecho e a parte posterior é almofadada com sistema de apoio acolchoado para as costas e alças almofadadas. Placa metálica removível com imã, para fácil gravação.

☒ 305 x 445 x 130 mm
 ↗ LSR - 37 x 12 mm



103



15" **Rocco** — 92626

Mochila em 840D para notebook até 15". Contém 1 bolso principal com 3 bolsos adicionais e um bolso frontal com vários compartimentos e zíper. Na parte posterior da mochila tem um encaixe para trolley.

☒ 300 x 370 x 60 mm
 ↗ TRS - 150 x 150 mm



123



Placa para personalização

15,6" **Olympia Plate** — 52276

Mochila para notebook em 840D jacquard com dois compartimentos forrados. O compartimento posterior tem divisória almofadada para notebook até 15.6" e o compartimento frontal diversos bolsos interiores. Bolso lateral em tela e bolso frontal. Parte posterior almofadada, com sistema de apoio acolchoado para as costas e alças almofadadas. Placa metálica removível com imã, para fácil gravação.

☒ 305 x 470 x 180 mm | Placa: 50 x 20 mm
 ↗ LSR - 37 x 12 mm



123

15,6" **Olympia** — 92276

Mochila para notebook em 840D jacquard com dois compartimentos. Compartimento posterior forrado, com divisória almofadada para notebook até 15.6". Compartimento frontal forrado, com diversos bolsos interiores. Bolso lateral em tela e bolso frontal. Parte posterior almofadada, com sistema de apoio acolchoado para as costas e alças almofadadas.

☒ 305 x 470 x 180 mm
 ↗ TRS - 130 x 50 mm



17" **Zagazig** — 92677

Mochila para notebook em 900D e c. sintético com 2 compartimentos. Compartimento posterior forrado, com divisória almofadada para notebook até 17" e bolso em tela, com zíper. Compartimento frontal forrado, com diversos bolsos interiores. Parte posterior e alças almofadadas.

330 x 450 x 160 mm

TR5 - 130 x 150 mm



NEW

15,6" **Derby** — 92523

Mochila para notebook em 900D e c. sintético com 2 compartimentos principais e bolso frontal. O compartimento posterior é forrado e tem divisória almofadada para notebook até 15,6" e bolso em tela, com zíper. O compartimento médio também é forrado e contém diversos bolsos interiores. A parte posterior e alças são almofadadas.

330 x 450 x 160 mm

TR5 - 50 x 160 mm

Material impermeável



Bangkok — 92636



Mochila para notebook em 600D de alta densidade e poliéster 600D impermeável. Compartimento principal almofadado para notebook até 15.6". Bolso frontal com zíper e dois bolsos laterais em tela. Parte posterior almofadada, com sistema de apoio acolchoado para as costas e alças almofadadas.

280 x 400 x 110 mm
 TRS - 120 x 180 mm



Lunar — 92164

Mochila para notebook em 600D de alta densidade. Compartimento com 2 divisórias almofadadas para notebook até 15.6" e tablet 9.7". Interior forrado e almofadado. Mochila com 1 bolso frontal e 2 bolsos laterais. Parte posterior almofadada, com sistema de apoio acolchoado para as costas e alças almofadadas.

290 x 390 x 155 mm
 TRS - 100 x 130 mm



Placa para personalização

Manaus — 92163

Mochila para notebook em 1680D e 300D com dois compartimentos para notebook 14" e para tablet 9.7". Interior forrado e almofadado. Bolso frontal com zíper, bolso lateral e placa metálica removível com imã, para fácil gravação.

310 x 400 x 110 mm | Placa: 50 x 20 mm
 LSR - 37 x 12 mm



103



Placa para personalização



Birmingham — 52637



Mochila para notebook em poliéster 600D impermeável com compartimento principal almofadado para notebook até 15.6". Bolso frontal e zípers impermeáveis. Bolso lateral em tela e parte posterior almofadada, com sistema de apoio acolchoado para as costas e alças almofadadas. Placa metálica removível com imã, para fácil gravação.

▮ 280 x 400 x 110 mm

▮ LSR - 40 x 12 mm



114

105

123



Osasco — 92637



Mochila para notebook em poliéster 600D impermeável e zípers impermeáveis. Compartimento principal almofadado para computador até 15.6". Contém um bolso lateral e um bolso frontal. Parte posterior almofadada, com sistema de apoio acolchoado para as costas e alças almofadadas.

▮ 245 x 400 x 115 mm

▮ TRS - 120 x 150 mm



• Material e zíper impermeáveis



• Material e zíper impermeáveis

123



Entrada USB



2 bolsos frontais



Bolso lateral

NEW

Denver — 92321

15,6"

Mochila para notebook em 300D melange. Inclui 1 compartimento principal com bolso interior forrado compatível com computador até 15,6" e diversos bolsos multifuncionais. A mochila tem 2 bolsos frontais, 1 lateral e entrada USB. A parte posterior e alças são almofadadas.

☒ 300 x 410 x 110 mm

☒ TRS - 120 x 120 mm

105



105



114



103



114



114



103



15,6" **Viena** — 92179

Mochila para notebook em 600D de alta densidade. Compartimento principal com divisória almofadada para notebook até 15,6". Bolso frontal com zíper. Parte posterior e alças almofadadas.

☒ 290 x 370 x 110 mm

☒ TRS - 140 x 100 mm



15,6" **Bremen** — 92182

Mochila para notebook em 600D de alta densidade. Compartimento principal com divisória almofadada para notebook até 15,6". Bolso frontal com zíper. Parte posterior e alças almofadadas.

☒ 290 x 370 x 110 mm

☒ TRS - 140 x 100 mm





Entrada USB



Bolso lateral



104



113



133



104



113



133



104



113



NEW

15,6"

Creta — 92085

Mochila para notebook em 300D com 1 compartimento principal com bolso forrado para computador até 15,6" e diversos bolsos interiores. Contém ainda bolso frontal, bolso lateral e entrada USB. Parte posterior e alças são almofadadas.

300 x 420 x 120 mm

TR5 – 150 x 150 mm



NEW

15,6"

Boracay — 52085

Mochila para notebook em 300D com placa de personalização. Tem 1 compartimento principal com bolso forrado para notebook até 15,6" e diversos bolsos interiores. Contém ainda bolso frontal, lateral e entrada USB. Parte posterior e alças são almofadadas.

300 x 420 x 120 mm

LSR – 35 x 15 mm



Placa para personalização

15,6" **Graphs Plate** — 52668

Mochila para notebook em 600D de alta densidade com compartimento com divisória almofadada para notebook até 15.6". Interior forrado e almofadado. Mochila com 2 bolsos frontais, parte posterior e alças almofadadas. Placa metálica removível com imã, para fácil gravação.

☒ 295 x 390 x 100 mm | Placa: 50 x 20 mm

🔪 LSR - 40 x 12 mm



15,6" **Graphs Bpack** — 92668

Mochila para notebook em 600D de alta densidade. Compartimento com divisória almofadada para computador até 15.6". Interior forrado e almofadado. A mochila tem 2 bolsos frontais com parte posterior e alças almofadadas.

☒ 295 x 390 x 100 mm

🔪 TRS - 180 x 140 mm



14" **Graphs Laptop** — 92286

Pasta para notebook em 600D de alta densidade. Compartimento forrado e almofadado, com divisória para notebook até 14". A pasta tem um bolso frontal, alça de ombro ajustável, com reforço almofadado e banda para transporte em trolley.

☒ 370 x 280 x 50 mm

🔪 TRS - 250 x 150 mm



15,6" **Santana** — 92266

Pasta para notebook em 600D 2Tone e 300D com compartimento forrado e divisória almofadada para notebook até 15.6". A pasta tem bolso frontal com diversos compartimentos interiores. No verso contém uma banda para transporte em trolley. Alça de ombro ajustável com reforço almofadado.

☒ 400 x 295 x 75 mm

🔪 TRS - 250 x 120 mm



Shades Bpack — 92170

Mochila para notebook em 600D de alta densidade. Compartimento principal forrado, com 2 divisórias almofadadas para computador até 14" e tablet até 9.7". A mochila tem 1 bolso frontal e 1 bolso lateral. Parte posterior e alças almofadadas.

310 x 400 x 110 mm

TR5 – 100 x 140 mm



Shades Plate — 52170

Mochila para notebook em 600D de alta densidade. Compartimento forrado, com duas divisórias almofadadas para notebook até 14" e tablet 9.7". Com um bolso frontal e lateral, parte posterior e alças almofadadas e placa metálica removível com imã, para fácil gravação.

310 x 400 x 110 mm | Placa: 50 x 20 mm

LSR – 40 x 12 mm



Placa para personalização



Shades Cross — 92173

Pasta à tiracolo em 600D de alta densidade. Compartimento principal forrado, divisória almofadada para tablet 9.7" e com diversos bolsos interiores. A pasta tem ainda bolso frontal e bolso posterior, alça de ombro ajustável e parte posterior almofadada.

220 x 270 x 45 mm

TR5 – 100 x 140 mm



Wiltz — 92168

Mochila para notebook em 600D de alta densidade com 2 compartimentos forrados. Compartimento posterior com diversos bolsos interiores e 2 divisórias almofadadas para notebook até 15.6" e tablet 10.5".

Compartimento frontal ideal para transporte de roupa (ou para lazer). Parte posterior e alças almofadadas. Alça para transporte em trolley.

300 x 450 x 160 mm

TR5 – 200 x 100 mm



105



105



104



133

14"

Kiev — 92622

Mochila para notebook em 600D de alta densidade. Compartimento principal com divisória almofadada para notebook até 14". Bolso frontal com zíper. Parte posterior e alças almofadadas.

☒ 290 x 400 x 140 mm

☑ TRS – 180 x 120 mm



114



114



105



123

15,6"

Brussels — 92169

Mochila para notebook em 600D. Contém bolso frontal com fecho e bolso lateral em tela. Compartimento com divisória para computador até 15.6". Interior forrado e almofadado com bolsos interiores. Alça de ombro ajustável e com reforço.

☒ 290 x 430 x 100 mm

☑ TRS – 180 x 120 mm



133



133



114



103

15,6"

Hexa — 92288

Mochila para notebook em 600D. Compartimento com divisória almofadada para notebook até 15.6". Bolso lateral em tela e bolso frontal. Parte posterior e alças almofadadas. Bateria e fone não inclusos.

☒ 310 x 450 x 120 mm

☑ TRS – 150 x 150 mm



103



103



114



133

Hexa Sport — 92515

Bolsa esportiva em 600D. Fundo com placa semi-rígida, bolso frontal com zíper e bolso em tela. Alça de ombro ajustável, com reforço. Squeeze não incluso.

☒ 460 x 290 x 220 mm

☑ TRS – 200 x 80 mm

Mais divisórias, mais arrumação para levar tudo o que precisa



A



April — 92545

Pochete em 600D de alta densidade. Compartimento principal e um zíper na parte posterior. A bolsa tem alça ajustável em webbing.

▮ 220 x 120 mm

▮ TRS - 120 x 45 mm



113

104

A



Muzeul — 92544

Bolsa de cintura em 300D de alta densidade. Compartimento principal com fecho e bolso interior em rede elástica e bolso na parte posterior de fácil acesso, ideal para guardar os bens com maior segurança. A parte frontal contém um bolso em rede elástica, um bolso com pala, botão para fecho e um elástico na lateral, indicado para pendurar mosquetões ou óculos de sol. A alça é ajustável em webbing com fecho.

▮ 270 x 120 x 65 mm

▮ TRS - 100 x 35 mm



Com apito

Reservatório de água com capacidade até **2L**



Yates —
92799
0.364

Elementos refletivos



 **Mounti** — 92628

Mochila desportiva em 420D com compartimento principal forrado e bolso frontal com zíper. Painel frontal com elementos refletivos. A parte posterior da mala e as alças são almofadadas para garantir um maior conforto para as costas. Ainda na parte posterior contém alça com fecho, para garantir que a mala é ajustada ao tronco, facilitando o seu transporte em movimento e uso prolongado. A mochila inclui um reservatório de água com capacidade até 2 L e canudo. A mochila e o reservatório são fornecidos separadamente.

▮ 265 x 410 x 55 mm

▮ TRS - 100 x 100 mm



103

Girald — 92520

Bolsa esportiva em poliéster 300D com alça de ombro ajustável, fundo com placa rígida, 1 bolso principal e 4 bolsos adicionais.

☒ 640 x 370 x 310 mm

☞ TRS – 230 x 170 mm



113



104

Bago — 92517

Bolsa esportiva em 300D e 1680D. Fundo com placa semi-rígida. Contém um bolso frontal com zíper, um bolso lateral em tela e um bolso lateral para sapatos. Alça de ombro ajustável, com reforço almofadado.

☒ 570 x 330 x 300 mm

☞ TRS – 200 x 100 mm



128



103



104



124



119

Fit — 92511

Bolsa esportiva em 600D com divisória interior e fundo com placa semi-rígida. Bolso frontal e bolso lateral para calçado, ambos com zíper. Alça de ombro ajustável.

☒ 520 x 300 x 255 mm

☞ TRS – 200 x 90 mm



105

Mochilas com cores para todos os gostos



Jaipur —
98408
📄 .313



109



105



104



109

124

104

105

128

108

119

103



105

128

119

104

124

131

103



104



113

Turim — 92471

Mochila em 600D com bolsos laterais em tela e bolso interior. Parte posterior e alças almofadadas.

☒ 250 x 420 x 180 mm

🔪 TRS - 90 x 70 mm

Berna — 92667

Mochila em 600D com bolso frontal com fecho. Parte posterior e alças almofadadas.

☒ 310 x 410 x 120 mm

🔪 TRS - 130 x 80 mm

City — 92665

Mochila em 600D com saída para fone de ouvido. Interior forrado, com bolso e 2 bolsos laterais em rede. Parte posterior e alças almofadadas.

☒ 270 x 400 x 140 mm

🔪 TRS - 120 x 95 mm



Juco: o novo tecido ecológico

A combinação entre o algodão e a juta resulta num material de alta durabilidade e resistência: o Juco. Um tecido sustentável, versátil e cada vez mais presente no nosso dia a dia.



Padova —
92937

 .291



160

NEW



Marbella — 92938

Mochila em juco (275 g/m²) com um compartimento principal e bolso frontal com fecho. Pega em webbing de algodão no topo e alças ajustáveis em algodão bicolor.

📏 270 x 350 x 70 mm

🔪 TRS - 150 x 180 mm



114



Alças reflexivas nas laterais

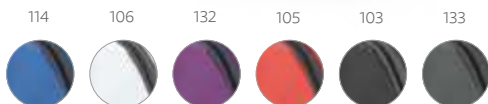

Gauteng — 92638

Mochila dobrável em 210D ripstop com bolso frontal e dois bolsos laterais em tela.

∓ 330 x 400 x 120 mm | Dobrada: 195 x 160 x 25 mm

✂ TRS - 120 x 100 mm



109



Barcelona — 92669

Mochila dobrável em 210D ripstop com bolso frontal. Fornecida desdobrada.

∓ 295 x 415 x 110 mm | Dobrada: 160 x 130 mm

✂ TRS - 160 x 70 mm



133



Carnaby
92910

∓ .307



Toronto — 92568

Sacola esportiva dobrável em 210D ripstop com bolso frontal. Fornecida desdobrada.

∓ Ø240 x 410 mm | Dobrado: 160 x 160 mm

✂ TRS - 100 x 80 mm



114

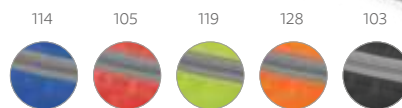

Munich — 92569

Pochete em 210D ripstop com saída para fone de ouvido. Bolsa com zíper e alça ajustável.

∓ 250 x 80 mm

✂ TRS - 200 x 20 mm



Leves e práticas

Acompanham-no para qualquer lugar.



104



103

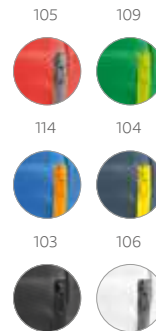

105

109

114

104

103

106



105

Logan — 52635

Mochila em 600D com bolso exterior frontal com zíper. Parte posterior almofadada, com sistema de apoio acolchoado para as costas e alças almofadadas.

▮ 245 x 400 x 115 mm

▮ TRS – 100 x 120 mm

Bertle — 92635

Mochila em 600D com bolso exterior frontal com zíper. Parte posterior almofadada, com sistema de apoio acolchoado para as costas e alças almofadadas.

▮ 245 x 400 x 115 mm

▮ TRS – 90 x 60 mm



114

114

123

Tangram — 92291

Pasta multifunções em 600D. Contém 2 bolsos frontais com zíper e alça de ombro ajustável com reforço.

☒ 380 x 300 x 80 mm

✂ TRS – 150 x 140 mm



105

105

104

103

Seoul — 92257

Pasta multifunções em 600D. Compartimento exterior aberto (forrado) com bolso frontal com zíper. A pasta tem alça de ombro ajustável e alças de mão com reforço.

☒ 400 x 300 x 100 mm

✂ TRS – 200 x 120 mm



103

Frankfurt — 92156

Pasta de congresso em 600D com interior forrado.

☒ 380 x 280 x 50 mm

✂ TRS – 280 x 70 mm



104

104

103

Doha — 92236

Pasta de congresso em 600D com zíper, ideal para transportar documentos.

☒ 390 x 290 x 80 mm

✂ TRS – 280 x 120 mm



160



ecologic



Nisa — 92274

15,6"

Pasta para notebook em cortiça. Compartimento forrado e almofadado, com divisória para notebook até 15.6". A pasta tem um bolso frontal e alça de ombro ajustável, com reforço almofadado. Fornecida em embalagem de non-woven.

410 x 310 x 75 mm | Sacola: 490 x 378 mm

TR5 - 40 x 18 mm



123

Suporte para esferográficas

Chicago — 92258

15,6"

Pasta para notebook até 15.6" em 600D com interior forrado e almofadado. Tem 2 bolsos frontais e alça de ombro ajustável. A pasta tem suporte para esferográficas (não inclusas).

400 x 300 x 80 mm

TR5 - 150 x 150 mm



104

104

103



Garbi — 92197

14"

Pasta para notebook até 14" em poliéster 600D com alça de ombro ajustável e reforçada, 1 bolso principal e 2 bolsos adicionais. Interior forrado e almofadado.

370 x 290 x 60 mm

TR5 - 200 x 150 mm



Milo — 92316

Pasta congresso em 600D com 1 bolso principal e zíper. Indicada para transportar documentos.

☒ 390 x 300 x 40 mm

✂️ TXP – 260 x 150 mm



Kayl — 92357

Pasta de congresso em non-woven (80 g/m²) com 1 compartimento com zíper. Ideal para transportar documentos.

☒ 380 x 300 mm

✂️ TXP – 260 x 150 mm



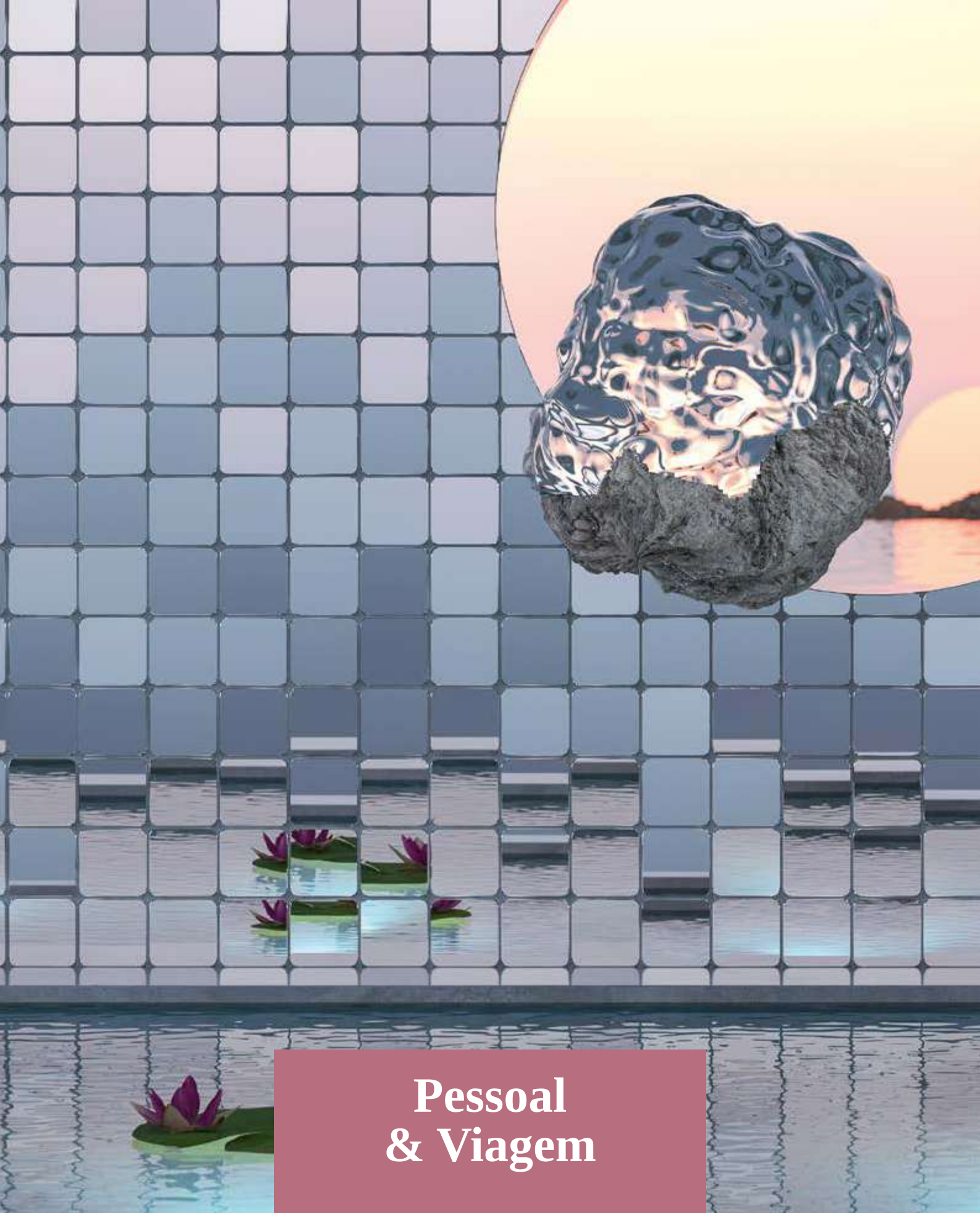

**Pessoal
& Viagem**



Repurpose Collection



Repurpose Backpack — 92080

📏 .174



Repurpose Sports — 92079

📏 .174



Repurpose Cooler — 98427

📏 .315



PET Reciclado

O rPET é muito mais do que plástico reciclado. As suas aplicabilidades são muitas e podem estar presente em vários objetos do dia a dia.



Interior forrado



113

104



NEW

ecologic



Repurpose Bag — 92078

Nécessaire em rPET 600D com interior forrado. Bolso frontal com zíper e pega lateral em webbing.

📏 220 x 120 x 110 mm

🔪 TRS - 140 x 35 mm

Repurpose
our future



Algodão e cortiça: a união perfeita

Materiais extremamente versáteis e resistentes, tornando qualquer objeto mais forte e sustentável.



150

ecologic



Blanchett — 92735

Bolsa de cosméticos 100% algodão (280 g/m²) com detalhes em cortiça no fundo da bolsa e puxador do fecho, que também tem a função de pega para facilitar o transporte. O interior é forrado, sendo de fácil limpeza e rápida secagem, ideal para guardar maquiagem.

▮ 220 x 130 x 80 mm

✂ TRS - 95 x 60 mm



Algodão reciclado

Proveniente do excedente da produção têxtil, este tipo de algodão torna o processo mais sustentável.

160

160



104



103



NEW

ecologic



Millie — 92077

Bolsa multifunções com algodão reciclado (140 g/m²) e zíper.

225 x 120 mm

TR5 - 180 x 80 mm



144



Eliza — 92731

Bolsa de cosméticos em 300D de alta densidade com pega almofadada, interior forrado e bolso interior com zíper.

☒ 200 x 115 x 140 mm

✂ TRS – 140 x 60 mm



131

● Fecho de dois sentidos



Crowe — 92715

Bolsa de cosméticos em microfibra com detalhe em c. sintético e zíper duplo.

☒ 180 x 120 x 100 mm

✂ TRS – 30 x 15 mm



105



Kevin — 92728

Bolsa de cosméticos em 300D de alta densidade com pega, bolso frontal, interior forrado e zíper.

☒ 220 x 115 x 115 mm

✂ TRS – 150 x 50 mm



113



Wayne — 92732

Bolsa de cosméticos em 600D de alta densidade com pega e interior forrado.

☒ 220 x 110 x 110 mm

✂ TRS – 140 x 60 mm



Vários bolsos interiores e gancho no topo

A



116



133



104



105



116

A

Milli — 92148

Bolsa de cosméticos em 600D de alta densidade. O compartimento principal tem zíper duplo e revestimento interior em 210D. Contém vários bolsos interiores e gancho no topo para pendurar.

☒ 250 x 180 x 105 mm

☒ TRS - 100 x 110 mm



103



103



104



105

Cotia — 92723

Bolsa de cosméticos com pega e bolso frontal em 300D.

☒ 240 x 160 x 55 mm

☒ TRS - 150 x 60 mm



104



104



131



103



Willis — 92724

Bolsa de cosméticos em microfibra com vários bolsos interiores e gancho de pendurar.

☒ 200 x 160 x 85 mm

☒ TRS - 120 x 60 mm

Cores metálicas



Loren — 92713

Bolsa multiusos em PVC com zíper, disponível em cores metalizadas. Prática e compacta ideal para uso diário ou em viagem.

☒ 140 x 95 x 70 mm
 ✂ SCR – 100 x 60 mm



Bree — 92852

Bolsa multiusos em non-woven (80 g/m²) e termo-selada.

☒ 300 x 270 x 120 mm
 ✂ TXP – 140 x 140 mm



Weida — 92719

Bolsa de cosméticos em 600D com pega e bolso frontal.

☒ 200 x 115 x 85 mm
 ✂ TRS – 140 x 60 mm



Eastwood — 92730

Bolsa de cosméticos em 600D com pega e interior forrado.

☒ 220 x 120 x 120 mm
 ✂ TRS – 140 x 60 mm



Marie — 92721

Bolsa multiusos em microfibra com zíper.

∓ 130 x 90 x 65 mm

↗ TRS – 80 x 30 mm



Annie — 92717

Bolsa de cosméticos em microfibra e rede com zíper.

∓ 210 x 130 x 85 mm

↗ TRS – 90 x 90 mm



Anjelica — 92716

Bolsa de cosméticos em microfibra e tela.

∓ Ø155 x 145 mm

↗ TRS – 90 x 20 mm



A

Deniro — 92722

Bolsa de cosméticos hermética em PVC. Incluso 3 frascos (2 x 65 ml e 60 ml), 1 vaporizador (80 ml) e 1 funil. Apropriada para transporte em cabine de avião.

☒ 190 x 155 x 40 mm

✂ SCR – 120 x 100 mm

● Inclui frascos

B

Valentina — 92720

Bolsa de cosméticos hermética em PVC. Apropriada para transporte em cabine de avião. Frascos não inclusos.

☒ 165 x 185 x 40 mm |

Capacidade < 1 Litro

✂ SCR – 110 x 110 mm

105

**Ingrid I** — 92733

Bolsa hermética em EVA com fecho.
Apropriado para viagem de avião.

☿ 200 x 125 mm

✂ SCR - 120 x 45 mm

102

**Chastain** — 92737

Bolsa de cosméticos em EVA com fecho de correr e puxador metálico. Apropriado para viagem de avião.

☿ 200 x 145 x 70 mm

✂ SCR - 100 x 50 mm

103

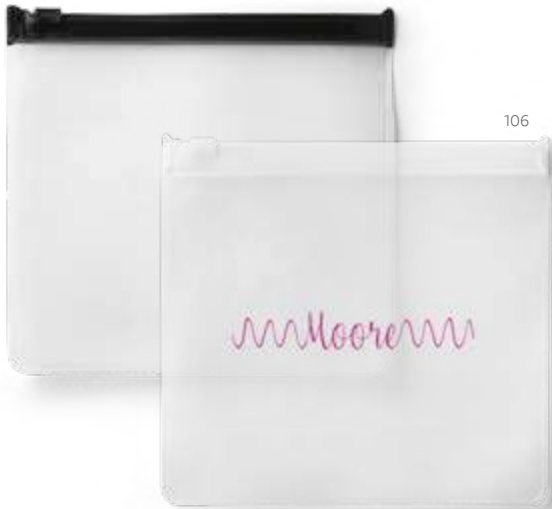

106

Ingrid II — 92734

Bolsa hermética em EVA com fecho.
Apropriado para viagem de avião.

☿ 150 x 160 mm

✂ SCR - 100 x 80 mm

104

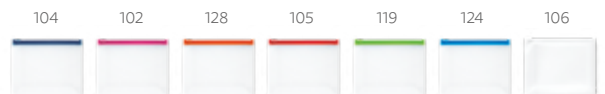
**Margot** — 92741

Bolsa hermética em EVA com fecho de correr.
Apropriado para viagem de avião.

☿ 190 x 150 x 50 mm

✂ SCR - 100 x 50 mm

Temporizador
de **5 minutos**



106

Elora — 94300

Ampulheta de banho em ABS com ventosa que permite a rotação do produto quando colocado na parede. Incluso temporizador de 5 minutos.

☒ 100 x 128 x 35 mm

✂ SCR – 20 x 50 mm



112



112

106

103

Euna — 94852

Kit de 4 lixas. Composto por: 2 lixas abrasivas e 2 lixas polidoras.

☒ 22 x 65 x 17 mm

✂ PDP – 15 x 35 mm



112



112

106

103

Aniston — 94856

Conjunto de 6 lixas para unhas fornecido em caixa de cartão personalizável.

☒ 55 x 61 x 6 mm

✂ PDP – 40 x 30 mm



112



102



110



103



127



112

104

106

103



Nadia — 94843

Conjunto de 4 peças para manicure: cortador de unhas, tesoura, pinça e empurra cutículas. Fornecido em estojo.

☒ 100 x 53 x 20 mm

✂ PDP – Ø20 mm

Lopez — 94857

Conjunto de 4 peças para manicure em bolsa de PVC. Composto por lixa, pinça, corta unhas e empurra cutículas.

☒ 66 x 105 mm

✂ PDP – 40 x 30 mm

Gavis — 94835

Espelho de maquiagem duplo.

☒ 68 x 64 x 11 mm

✂ PDP – 50 x 25 mm

Conjuge a sua Higiene com produtos ECologic



B

A

160

A

NEW **ECologic**



Zena — 94897

Conjunto de manicure em cortiça com cinco peças em aço inoxidável: lixa, tesoura, cortador de unhas, pinça e empurra cutículas. Fornecido em bolsa de papel natural.

∓ 104 x 61 x 17 mm
 ⚡ LSR - 40 x 30 mm



119

105



Streep — 94853

Espelho de maquiagem com formato redondo, prático e com o tamanho ideal para transportar na bolsa.

∓ Ø60 x 5 mm
 ⚡ DUV - 47 x 47 mm

160

B

NEW **ECologic**



Tilbury — 94898

Espelho de bolsa duplo em cortiça com fecho magnético. Fornecido em bolsa de papel natural.

∓ Ø73 x 20 mm
 ⚡ LSR - Ø40 mm



Estar bem com você mesmo!

A organização é fundamental para uma sensação de conforto e bem-estar. Mantenha por perto tudo o que precisa e sinta-se mais tranquilo.



Roberts — 94306
 BPA FREE Porta comprimidos com 4 divisórias com tampa, disponível em várias cores. Food grade.
 60 x 60 x 18 mm
 PDP – 20 x 20 mm



Cortador de comprimidos



Nero — 94307
 BPA FREE Porta comprimidos com tampa, 2 divisórias e cortante. As divisórias são extraíveis e coloridas, facilitando a sua distinção. Food grade.
 94 x 48 x 16 mm
 PDP – 50 x 30 mm



Stiller — 94301
 BPA FREE Caixa de comprimidos com 3 divisórias.
 60 x 35 x 13 mm
 PDP – 40 x 25 mm



7 divisórias para cada dia da semana



Jimmy — 94305
 BPA FREE Porta comprimidos com tampa e 7 divisórias, ideal para separar pelos dias da semana. Food grade.
 85 x 55 x 20 mm
 PDP – 55 x 32 mm



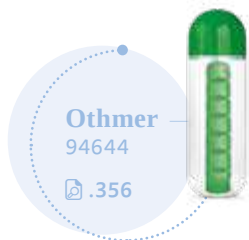

Othmer
94644

📦 .356

Copo de viagem
com caixa para
comprimidos



150

ecologic



Nadal — 94769

Copo de viagem retrátil
em fibra de bambu (50%) e PP (50%)
com capacidade até 210 ml. Incluso caixa
para comprimidos e mosquetão.

📏 Ø65 x 33 mm

🔪 PDP - Ø35 mm



Frasco
recarregável
e reutilizável

Reflask 500 — 94913

Frasco com doseador em PET e PP, com capacidade até 500 ml. Frasco recarregável e reutilizável.

∅ 85 x 150 mm

DUV - 30 x 40 mm



Lyze II — 92725

Frasco PETG de 50 ml com tampa flip top e mosquetão. Indicado para colocar álcool gel.

∅ 45 x 120 mm

STI - 30 x 50 mm



Healty 5L — 94895

Álcool em Gel Galão 5 Litros 70% antisséptico para higienização a seco das mãos e superfícies. Combate 99,9% dos germes e bactérias e hidrata a pele com solução protetora da pele, diminuindo o impacto do ressecamento provocado pelo álcool. Embalagem transparente em PP. Ideal para desinfetar ambientes profissionais. Instruções de uso: Aplicar o produto diretamente no local a ser higienizado, espalhar e deixar secar, sem enxágue. Não utilizar em superfícies sensíveis ao álcool. Armazenamento: Manter o produto em local arejado, longe do calor e do fogo. Dermatologicamente testado e certificado pela ANVISA. Disponível personalização do frasco com logomarca.

∅ 280 x 190 x 140

SCR - 110 x 95 mm



Healty 500 — 94894

Álcool em Gel 500ml 70% antisséptico para higienização a seco das mãos e braços. Combate 99,9% dos germes e bactérias e hidrata a pele com solução protetora da pele, diminuindo o impacto do ressecamento provocado pelo álcool. Embalagem transparente em PP. Ideal para ter no escritório ou em casa. Instruções de uso: Aplicar uma pequena quantidade de Álcool Gel na palma da mão e espalhar até total absorção, sem enxágue. É recomendada a sua utilização para completar a limpeza rotineira das mãos. Dermatologicamente testado e certificado pela ANVISA. Disponível personalização do frasco com logomarca.

∅ 70 x 200 mm

PDP - 45 x 65 mm



Healty 100 — 94893

Álcool em Gel 100ml 70% antisséptico para higienização a seco das mãos e braços. Combate 99,9% dos germes e bactérias e hidrata a pele com solução protetora da pele, diminuindo o impacto do ressecamento provocado pelo álcool. Embalagem transparente em PP. Ideal para levar sempre na bolsa ou mochila e usar em qualquer lugar. Instruções de uso: Aplicar uma pequena quantidade de Álcool Gel na palma da mão e espalhar até total absorção, sem enxágue. É recomendada a sua utilização para completar a limpeza rotineira das mãos. Dermatologicamente testado e certificado pela ANVISA. Disponível personalização do frasco com logomarca.

∅ 36 x 125 mm

PDP - 25 x 60 mm



Healty 60 — 94892

Álcool em Gel 60ml 70% antisséptico para higienização a seco das mãos e braços. Combate 99,9% dos germes e bactérias e hidrata a pele com solução protetora da pele, diminuindo o impacto do ressecamento provocado pelo álcool. Embalagem transparente em PP. Ideal para levar sempre na bolsa ou mochila e usar em qualquer lugar. Instruções de uso: Aplicar uma pequena quantidade de Álcool Gel na palma da mão e espalhar até total absorção, sem enxágue. É recomendada a sua utilização para completar a limpeza rotineira das mãos. Dermatologicamente testado e certificado pela ANVISA. Disponível personalização do frasco com logomarca.

∅ 38 x 90 mm

PDP - 25 x 45 mm



Proteja-se! Mais prevenção, maior segurança

LED Whidy — 94953

Dispenser automático de sabão ou desinfetante em ABS e PP com sensor infravermelho de movimento com LED branco no interior do recipiente e capacidade de 330 ml (sabão ou desinfetante não incluídos). Incluso 4 pilhas AAA. Fornecido em caixa.

123 x 195 x 83 mm

PDP - 15 x 15 mm

330 ml

106



1m

LED Germout — 58519

Caixa esterilizadora em ABS e PC com combinação entre radiação UVC e UVA que permite a eliminação de um número significativo de bactérias. A caixa possui 2 leds UV no interior com uma potência total de 2W, e foi especialmente desenhada para a eliminação de bactérias em objetos de uso diário, como: chaves, celulares, smartphones, máscaras, óculos, comandos, jóias, e outros pequenos utensílios. Eficiência de 70% com apenas 1 ciclo de 5 minutos, e 99,9% com dois ciclos de 5 minutos. Possui um sensor de segurança que desliga de imediato as lâmpadas assim que é aberta a caixa. A parte superior da caixa Incluso um carregador wireless de carregamento rápido (10W), com entrada de 5V/3A e porta de carregamento USB tipo C. Incluso cabo de 1 metro. Fornecida em caixa presente.

210 x 120 x 55 mm | Interior: 190 x 95 x 20 mm | Caixa: 240 x 130 x 71 mm

SCR - 150 x 70 mm

Carregador wireless
de carregamento
rápido



106





Em alumínio



A

NEW

Emil — 98111

Identificador de bagagem em alumínio com cordão. Ideal para malas de viagem.

▮ 80 x 42 x 2 mm

▮ LSR – 60 x 15 mm



Findo — 98124

Identificador de bagagem em PP. Ideal para malas de viagem.

▮ 87 x 50 x 4 mm

▮ PDP – 50 x 20 mm



Desfrute e viaje relaxado



Travelx — 98197

Kit de viagem composto por almofada de pescoço, máscara para dormir, tampões para ouvidos (não é um equipamento de proteção individual) e 1 par de meias. Fornecido com bolsa em 190T.

☒ Bolsa: 150 x 200 mm

☑ TRS - 100 x 100 mm



Dozy — 98113

Máscara para dormir em 190T com interior almofadado.

☒ 185 x 90 mm

☑ TRS - 100 x 35 mm



Strada — 98180

Almofada de pescoço inflável em PVC aveludado. Fornecida em bolsa.

☒ Vazio: 425 x 275 mm | Bolsa: 175 x 115 mm

☑ TRS - 100 x 25 mm



127



Cobb — 98117

Kit de limpeza de sapatos com 6 peças:
1 cera incolor para sapatos, 1 flanela
amarela, 2 escovas em madeira,
1 calçadeira e 1 embalagem lata.

∓ Ø98 x 56 mm

↗ LSR – Ø65 mm



106



106

102

Bilbo — 94879

Kit de costura prático e leve para levar em viagem.
Composto por 3 alfinetes, 3 agulhas, 1 pinça, 1 tesoura,
1 enfia linha, 1 alfinete, 2 botões, 2 colchetes e 6 rolos
de linhas de várias cores. Fornecido em estojo.

∓ 70 x 21 x 65 mm

↗ DUV – 60 x 45 mm



103

Gwenno — 92851

Bolsa para sapatos em non-woven
(80 g/m²) com cordões.

∓ 360 x 420 mm

↗ TXP – 250 x 250 mm



103

NEW

Neeson — 98093

Anti-estresse em espuma PU em formato de bola de futebol.

∓ ∅63 mm

➤ PDP – 10 x 10 mm



106

NEW

Lohan — 98091

Anti-estresse em espuma PU em formato de carro.

∓ 52 x 93 x 47 mm

➤ PDP – 40 x 10 mm



128

NEW

Hous — 98057

Anti-estresse em espuma PU em formato de casa.

∓ 70 x 80 x 70 mm

➤ SCR – 50 x 25 mm



105

Deep — 98012

Anti-estresse em espuma PU em formato de coração.

∓ 65 x 70 x 50 mm

➤ PDP – 25 x 15 mm

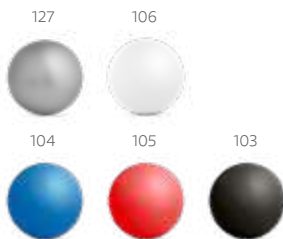

Chill — 98054

Anti-estresse em espuma PU em formato de bola, disponível em várias cores.

∓ ∅50 mm

➤ DUV – 25 x 20 mm



127

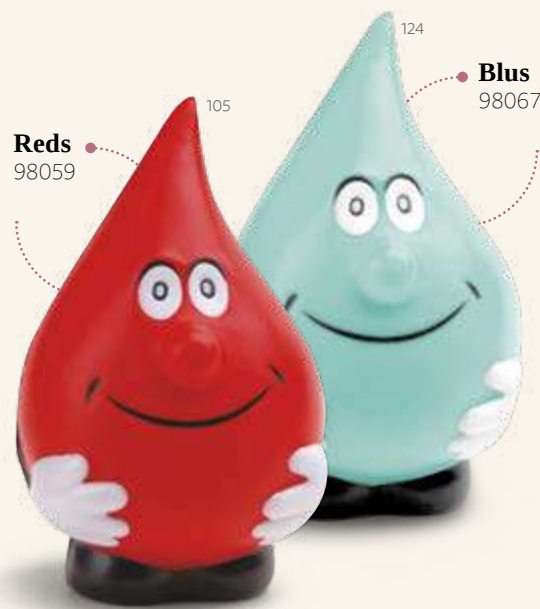

Reds
98059

105

124

Blus
98067

Blus — 98067

Reds — 98059

Anti-estresse em espuma PU em formato de gota.

∓ 65 x 110 x 65 mm

➤ PDP – 25 x 15 mm



112



112



105



124



106



103

Trotte — 95103

Kit de higiene para cachorro em PP. Contém 20 sacos higiênicos em PE. Porta-saco em formato de osso.

↕ Fechada: 111 x 21 x 15 mm

↗ PDP – 30 x 20 mm



108



Florian — 98514

Banda elástica refletora em poliéster com ajuste.

↕ 610 x 40 mm

↗ TRS – 100 x 6 mm

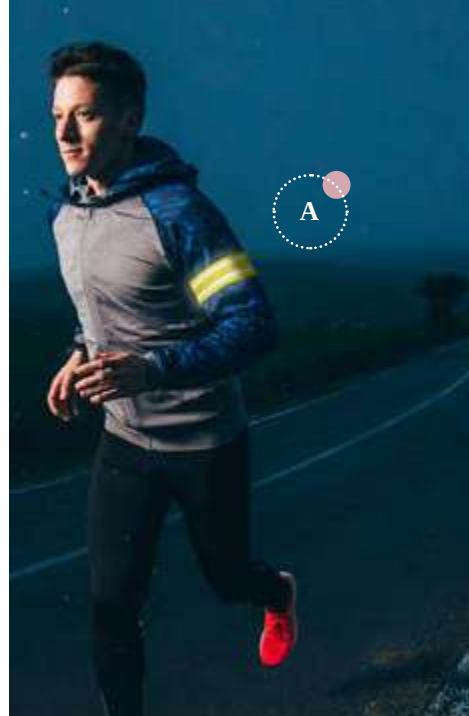

Paw — 93364

↗ .240

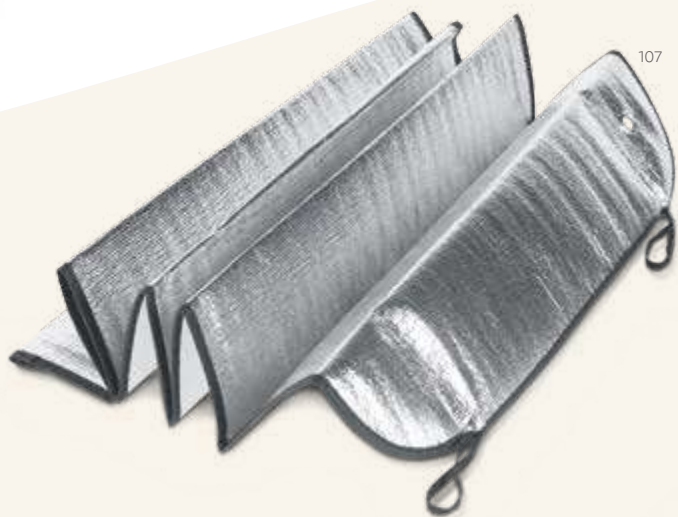

107



Guardsun — 98192

Protetor solar para carro sem PE bubble e forrado com folha de alumínio na frente e verso. Adequado para vidro frontal e incluso 2 fixadores de ventosa. Dobrável para facilitar arrumação.

↕ 1300 x 600 mm

↗ TXP – 500 x 300 mm



107



Sunshade — 98191

Protetor solar para carros em espuma de PE e forrado com 1 folha de alumínio. Adequado para vidro frontal e incluso 2 fixadores de ventosa. Dobrável para facilitar arrumação.

↕ 1300 x 600 mm

↗ TXP – 500 x 300 mm



B

O campismo é a melhor escolha para quem procura contato direto com a natureza e é uma excelente opção amiga do ambiente.

Suporta até **100kg**

Heiden — 99078

 .288



Thorpe — 99074
 Manta em tecido polar (180 g/m²) com alça removível para facilitar o transporte.
 1500 x 1200 mm
 TRS - 90 x 35 mm

Suporte para Squeeze



B

NEW

Throne — 98131
 Cadeira em 600D dobrável com suporte em rede para garrafa. Construção em metal que suporta até 100 kg. Fornecida em bolsa com alça.
 Aberta: 520 x 520 x 830 mm | Dobrada: 830 x 160 mm
 TRS - 200 x 120 mm

Bons aliados

O canivete é um dos acessórios mais úteis durante atividades ao ar livre como campismo, montanhismo e pesca. Opte pelos que têm fecho de segurança para maior proteção.



Inox **Ninja** — 94036

Canivete em aço inox e metal com fecho de segurança e clipe. Fornecido em caixa presente.

✂ 115 x 15 x 32 mm |
Caixa: 125 x 42 x 20 mm
✂ LSR – 35 x 10 mm



Inox **Alick** — 94035

Canivete em aço inox e metal com fecho de segurança e clipe. Fornecido em caixa presente.

✂ 97 x 15 x 29 mm |
Caixa: 110 x 37 x 20 mm
✂ LSR – 50 x 12 mm

• Com mosquetão



Inox **Fred** — 94037

Canivete em aço inox e metal com fecho de segurança e mosquetão. Fornecido em caixa presente.

✂ 101 x 10 x 29 mm |
Caixa: 108 x 39 x 15 mm
✂ LSR – 30 x 8 mm



B



Inox **Lawrence** — 94030

Canivete em aço inox e madeira com fecho de segurança e clipe.

✂ 115 x 16 x 36 mm

🔪 LSR - 25 x 5 mm

Com fecho de segurança



170



B

Inox **Falcon II** — 94031

Canivete em aço inox e madeira com fecho de segurança.

✂ 110 x 19 x 30 mm

🔪 LSR - 50 x 6 mm



170



Inox **Split** — 94038

Canivete em aço inox e madeira com fecho de segurança. Fornecido em caixa presente.

✂ 84 x 11 x 24 mm | Caixa: 94 x 33 x 16 mm

🔪 LSR - 30 x 10 mm



160



Inox **Norris** — 94032
 Faca em aço inox e madeira com bolsa de 600D. Fornecida em caixa.
 300 x 19 x 60 mm
 LSR - 40 x 10 mm



Inox **Wild** — 94040
 Canivete multifunções em aço inox com 12 peças e mosquetão. Fornecido em caixa presente.
 89 x 16 x 32 mm |
 Caixa: 104 x 39 x 20 mm
 LSR - 25 x 7 mm



Inox **Belpiano** — 94159
 Canivete multifunções em aço inox e madeira com 5 funções.
 90 x 25 x 12 mm
 LSR - 50 x 8 mm



Verbier — 94192
 Canivete multifunções em ABS e metal com 5 funções.
 59 x 17 x 8 mm
 PDP - 40 x 9 mm



Chaveiros
& Lanternas



B

A

C



Chaveiros amigos do ambiente

A cortiça é um material biodegradável e nobre, cuja transformação resulta em objetos leves, de toque suave e resistentes à humidade e ao atrito.



A



EcoLogic



Millau — 95051

Chaveiro em cortiça. Fornecido com caixa presente desmontada em cartão craft.

▮ 35 x 55 x 3 mm

▮ LSR - Ø20 mm

B



EcoLogic



Raldic — 93371

Chaveiro em cortiça e metal. Fornecido em caixa craft.

▮ 24 x 47 x 3 mm

▮ LSR - 33 x 13 mm

C



EcoLogic



Aloy — 95050

Chaveiro em cortiça em formato retangular. Fornecido com caixa presente desmontada em cartão craft.

▮ 35 x 60 x 3 mm

▮ LSR - 35 x 20 mm



Escolhas amigas do ambiente



160

A

ECOLOGIC

 **Lavre** — 93324

 Kit esferográfica e chaveiro em metal com acabamento em cortiça. Esferográfica com 1,5 km de escrita a azul. Fornecido em caixa presente de papel craft.

✂ Esferográfica: Ø9 x 139 mm | Porta-chaves: 24 x 47 x 3 mm | Caixa: 162 x 83 x 17 mm

✂ DUV – 100 x 50 mm



160

B

ECOLOGIC

 **Corks** — 93145

Chaveiro em cortiça e metal. Fornecido em caixa presente de papel craft.

✂ 20 x 100 mm | Caixa: 54 x 125 x 16 mm

✂ TRS – 10 x 50 mm

Presentes únicos



Travolta — 93314

Kit de porta cartões e chaveiro em c. sintético e metal. Fornecido em caixa almofadada.

Chaveiro: 15 x 92 x 8 mm |
Porta cartões: 97 x 65 x 11 mm |
Caixa: 154 x 143 x 34 mm

LSR - 25 x 7 mm



Brendon — 93315

Kit de porta cartões, chaveiro e esferográfica em c. sintético, metal e alumínio. Esferográfica com ponteira touch. Fornecido em caixa almofadada.

Porta cartões: 97 x 65 x 11 mm |
Chaveiro: 15 x 92 x 8 mm | Esferográfica: Ø11 x 135 mm |
Caixa: 174 x 163 x 34 mm

LSR - 35 x 6 mm





103



Lone — 93318

Porta cartões em metal e c. sintético.
Fornecido em caixa.

☒ 93 x 67 x 19 mm | Caixa: 98 x 72 x 22 mm

✂ LSR – 70 x 7 mm



103



Millard — 93280

Porta cartões em metal e c. sintético.
Fornecido em caixa presente.

☒ 95 x 64 x 13 mm

✂ LSR – 80 x 8 mm



101



103



Smith — 93308

Porta cartões em metal e c. sintético.
Fornecido em caixa.

☒ 97 x 63 x 14 mm |
Caixa: 105 x 70 x 15 mm

✂ LSR – 50 x 10 mm



Porta cartões com bloqueio RFID



104



104

106

103

Poppy — 93265

Porta cartões em PU com bloqueio de RFID e fita em poliéster para retirar facilmente seus cartões. Com capacidade para guardar até 2 cartões.

☒ 92 x 65 mm

✂ SCR – 45 x 45 mm



127



127

103

Muller — 93332

Porta cartões em alumínio com bloqueio de RFID e fita elástica em poliéster. O porta cartões tem acabamento mate e capacidade para 12 cartões. Seu formato compacto e funcionalidade de bloqueio RFID permitem que seja guardado de forma cómoda e segura em bolsos.

☒ 90 x 58 mm

✂ LSR – 50 x 20 mm



127

Dunedin — 93322

Porta cartões em alumínio.

☒ 95 x 55 x 6 mm

✂ LSR – 80 x 30 mm



A



103

• Com mosquetão giratório



Bourchier — 93363

Chaveiro em c. sintético e metal com mosquetão. Fornecido em caixa presente.

▮ 21 x 77 x 8 mm

▮ LSR - 15 x 20 mm



103

A

NEW



Blackwall — 93353

Chaveiro em metal e c. sintético. Fornecido em caixa presente.

▮ 21 x 100 x 11 mm

▮ LSR - 15 x 6 mm





114

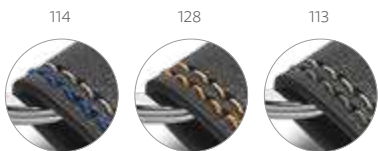

114

128

113



Bale — 93143

Chaveiro em c. sintético e metal.
Fornecido em caixa presente.

∓ 22 x 65 x 8 mm

↗ LSR – 15 x 33 mm



114

Com
mosquetão
giratório

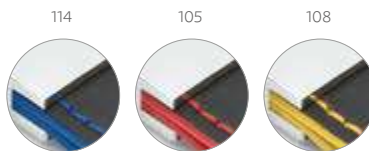

114

105

108



Leskov — 93370

Chaveiro em c. sintético e metal
com mosquetão giratório. Fornecido
em caixa presente.

∓ 17 x 80 x 7 mm

↗ LSR – 13 x 20 mm



103

A



Bachmann — 93171

Chaveiro em c. sintético e metal.
Fornecido em caixa presente.

∓ 38 x 76 x 9 mm

↗ LSR – 10 x 25 mm



A



101 Kloden — 93172
 Chaveiro em c. sintético e metal.
 Fornecido em caixa presente.
 39 x 74 x 5 mm
 LSR – 18 x 30 mm



103 Kendal — 93156
 Chaveiro em c. sintético e metal.
 Fornecido em caixa.
 34 x 70 x 4 mm
 LSR – 15 x 35 mm



147 Froome — 93396
 Chaveiro em metal. Fornecido em caixa presente.
 32 x 53 x 4,5 mm
 LSR – 25 x 12 mm



147 Diamond — 93395
 Chaveiro em metal. Fornecido em caixa presente.
 28 x 47 x 4,5 mm
 LSR – 22 x 14 mm

Chaveiros em metal



Com abridor de squeezes



Com abridor de squeezes



107

NEW

Blake — 93367

Chaveiro em metal com abridor de garrafas. Fornecido com bolsa de non-woven.

∩ 36 x 67 x 3 mm | Bolsa: 60 x 100 mm

⚡ LSR - Ø18 mm



107



Ringbolt — 93368

Chaveiro em metal com abridor de garrafas. Fornecido em caixa presente.

∩ 29 x 52 x 4 mm

⚡ LSR - 15 x 27 mm



107

Helli — 93394

Chaveiro em metal com abridor de garrafas.

∩ 22 x 42 x 9 mm

⚡ LSR - 20 x 9 mm



127

NEW



Zabel — 93158

Chaveiro em metal. Fornecido em caixa presente.

∩ 30 x 54 x 4 mm

⚡ LSR - 30 x 17 mm



107



Ulrich — 93084

Chaveiro em metal em formato de casa. Fornecido em caixa presente.

∩ 49 x 36 x 3 mm

⚡ LSR - 30 x 15 mm



A

NEW



Wagoner — 93341

Chaveiro em metal em formato de caminhão. Fornecido em caixa de oferta.

∓ 26 x 71 x 3 mm

↗ LSR – 35 x 15 mm



107

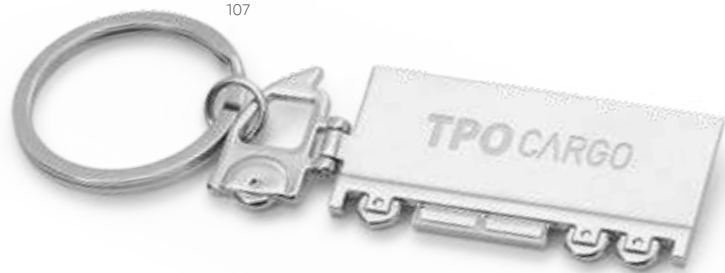

103



Jamp — 93155

Chaveiro em metal. Fornecido em caixa.

∓ 30 x 35 x 5 mm

↗ LSR – 18 x 22 mm



103



A

NEW



Flemi — 93397

Chaveiro em metal. Fornecido em caixa presente.

∓ 28 x 52 x 3 mm

↗ LSR – 20 x 25 mm





Paw — 93364

Chaveiro em formato de osso em alumínio.

▮ 38 x 25 x 1 mm

⚡ LSR - 25 x 10 mm



Mobby — 93165

Chaveiro em formato de carro em alumínio.

▮ 45 x 36 x 2 mm

⚡ LSR - 17 x 17 mm



Homier — 93167

Chaveiro em formato de casa em alumínio.

▮ 38 x 35 x 2 mm

⚡ LSR - 25 x 22 mm



Beat — 93159

Chaveiro em formato de coração em alumínio.

▮ 36 x 34 x 2 mm

⚡ LSR - 20 x 15 mm



Stitch — 93356

Chaveiro em alumínio.

▮ 29 x 54 x 1 mm

⚡ LSR - 20 x 30 mm

Formatos originais para presentes diferentes



103



119



128



Becket — 93372
Chaveiro em metal e ABS.
┆ 29 x 40 x 4 mm
┆ LSR - 25 x 25 mm



Basso — 93391
Chaveiro em formato de coração
em metal e ABS.
┆ 42 x 34 x 4 mm
┆ LSR - 20 x 15 mm



105



Vivre — 93392
Chaveiro em formato de casa
em metal e ABS.
┆ 42 x 37 x 4 mm
┆ LSR - 25 x 20 mm



114



114



114

105

107

147

103



104



103



104



103



103



104

LED Gobo — 94006

Chaveiro com lanterna LED e ferramenta. Incluso 4 pilhas LR41.

∅ 62 x 30 x 12 mm

LSR - 50 x 15 mm

LED Cleat — 93360

Chaveiro em ABS com luz LED. Incluso 3 pilhas AG10.

∅ 31 x 77 x 14 mm

LSR - 15 x 35 mm

3 luzes LED

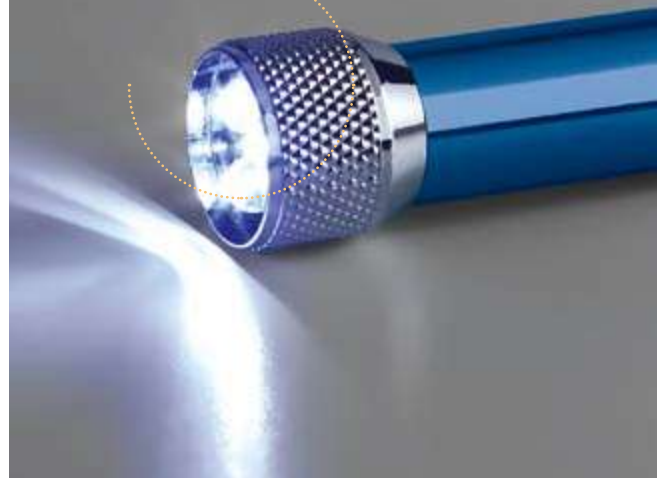

LED Lergan — 93141

Chaveiro em alumínio com lanterna de 3 luzes LEDs. Incluso 4 pilhas LR44.

∅ 17 x 62 mm

LSR - 7 x 30 mm



109

114

105

103

NEW

LED Brighter — 94746



Chaveiro com lanterna em alumínio e LED interior. Incluso 4 pilhas LR44. Fornecida em caixa presente.

∅ Fechada: 17 x 65 mm |

Caixa: 73 x 33 x 25 mm

LSR - 30 x 8 mm

Chaveiros com funções extra



114



103

Com abridor de squeezes



147

6 luzes LED



LED

Pantani — 93140

Chaveiro com LED e abridor de garrafas. Incluso 2 pilhas LR41.

∅ 34 x 68 x 11 mm

LSR — 18 x 27 mm



LED

Screebe — 94729

Lanterna em alumínio com 6 LEDs, abridor de garrafas e mosquetão. Incluso 2 pilhas CR2032.

∅ 25 x 102 mm

LSR — 40 x 8 mm

Com abridor de squeezes



103



109

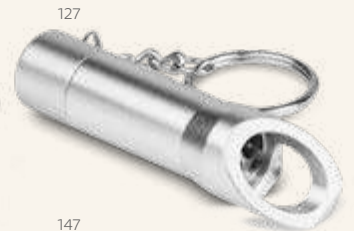

127



114



114



147

LED

Leif — 93154

Chaveiro em metal com lanterna LED e abridor de garrafas. Incluso 3 pilhas LR41.

∅ 14 x 62 mm

LSR — 5 x 28 mm

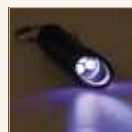

LED

Torchen — 93267

Lanterna em metal com 3 LEDs, abridor de garrafas e chaveiro. Incluso 3 pilhas LR44.

∅ 18 x 72 mm

LSR — 23 x 7 mm

3 luzes LED



Baitt — 93151

Chaveiro em alumínio com abridor de garrafas.

∓ 11 x 60 x 15 mm
 ↗ LSR – 40 x 8 mm



Clane — 94195

Chaveiro em alumínio com abridor de garrafas.

∓ 15 x 68 x 13 mm
 ↗ LSR – 25 x 8 mm



Kilmoon — 94196

Chaveiro em alumínio com abridor de garrafas.

∓ 30 x 89 x 2,5 mm
 ↗ LSR – 20 x 20 mm

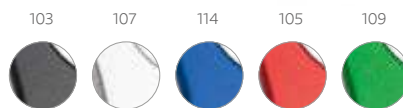

Close — 98824

Mosquetão em alumínio com abridor de garrafas. Não adequado para escalada esportiva.

∓ 44 x 79 x 3 mm
 ↗ LSR – 50 x 5 mm





A



A

Nate — 53197
 Chaveiro multifunções em metal.
 13 x 55 x 7 mm
 LSR - 45 x 8 mm



Verbier — 94192
 .228

Trudy — 93398
 Chaveiro em metal com apito.
 Ø7 x 45 mm
 LSR - 20 x 6 mm

Com apito



Suporte para celular



Nicolaus — 94446

Porta cartões em silicone com cordão e suporte para celular.

Porta-cartões: 57 x 86 x 4 mm | Lanyard: 420 mm

SCR – 35 x 35 mm

Chaveiro no interior



Miller — 93124

Bolsa pequena multiusos em 600D com fecho de correr e chaveiro no interior.

120 x 80 mm

TRS – 90 x 40 mm

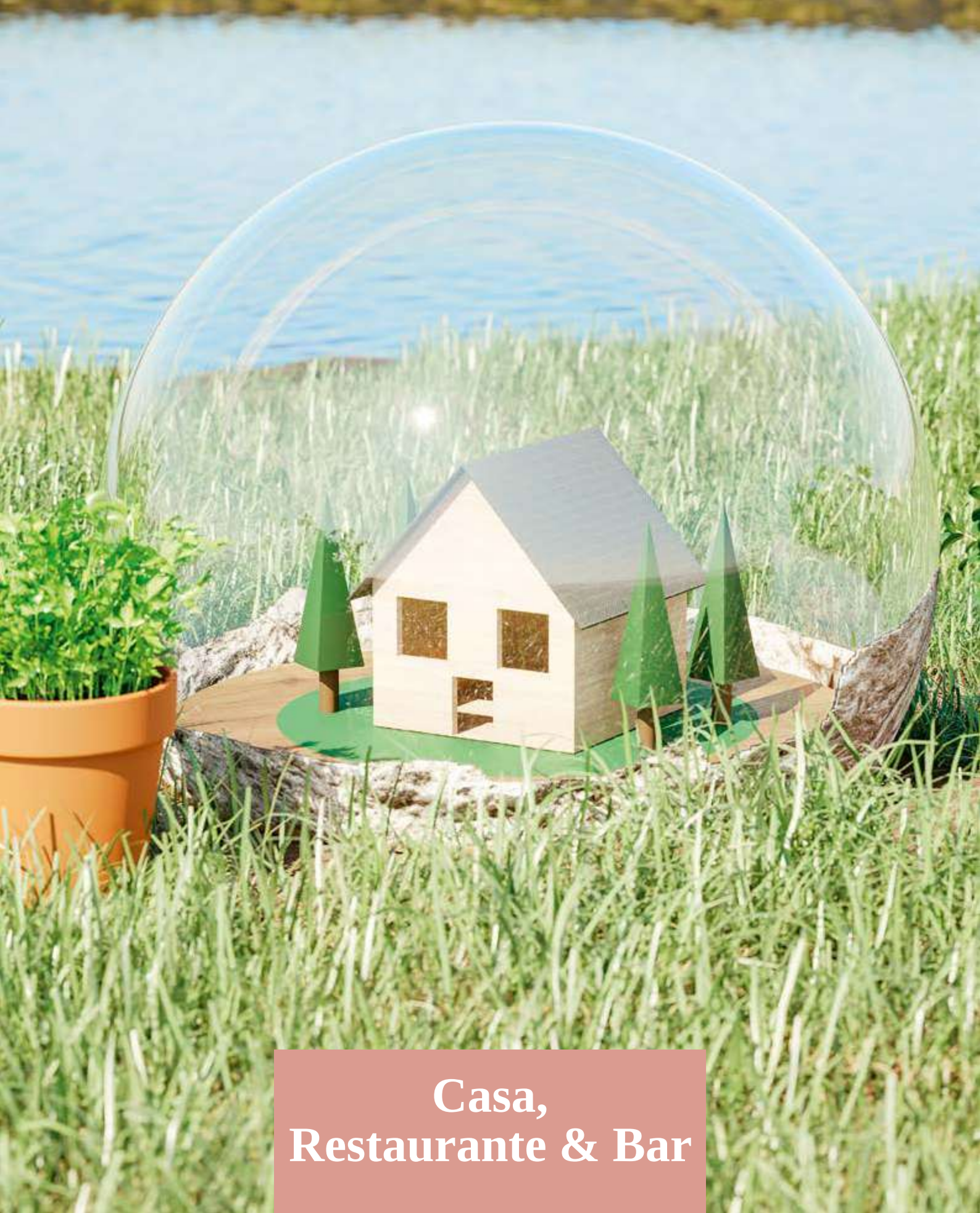

Casa,
Restaurante & Bar



B

C

A



Elegância nos jantares de família

De diferentes tamanhos e formatos, tábuas de bambu, um material ECOlogic e de qualidade para associar à sua marca.



A

NEW

ECOlogic



Caraway Round — 94259

Tábua de servir em bambu com pega, de grande dimensão e de utilização versátil. Ideal para pizza. Food grade. Fornecido com caixa presente de papel craft.

310 x 408 x 12 mm

LSR – 70 x 9 mm

B

NEW

ECOlogic



Caraway — 94260

Tábua de servir em bambu com pega, de grande dimensão e de utilização versátil. Food grade. Fornecido com caixa presente de papel craft.

240 x 450 x 12 mm

LSR – 70 x 9 mm

C

NEW

ECOlogic



Caraway Long — 94258

Tábua de servir em bambu com pega, de grande dimensão e de utilização versátil. Food grade. Fornecido com caixa presente de papel craft.

155 x 600 x 12 mm

LSR – 70 x 9 mm



B

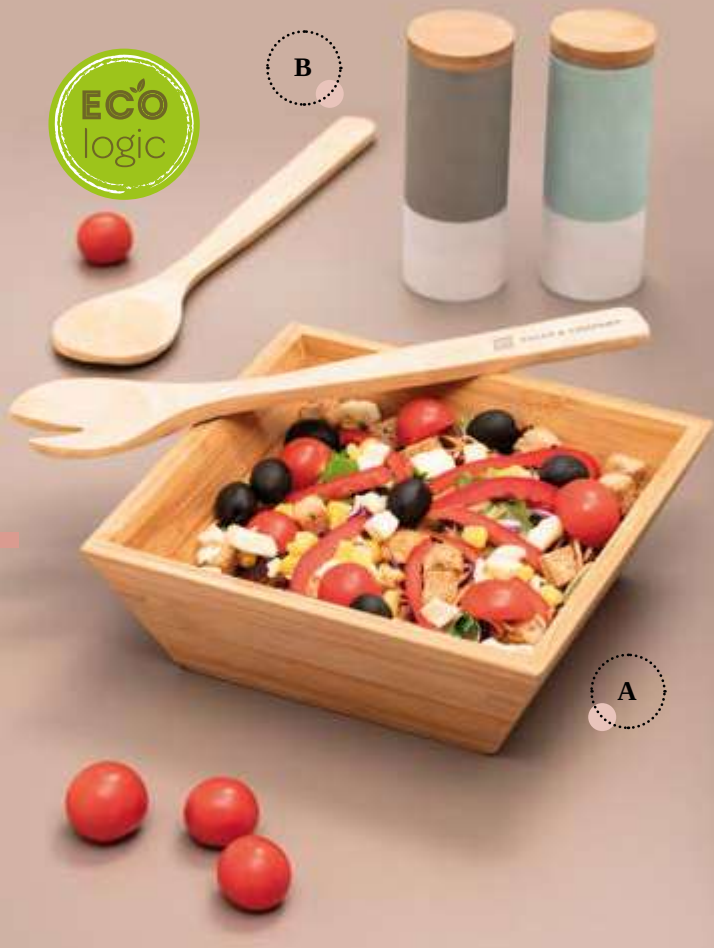

A



160

A

ECologic

Pepper — 93968

Saladeira em bambu em formato quadrado. Adicione o conjunto SALVY de 2 talheres para salada em bambu para compor este brinde ecológico. Food grade.

214 x 214 x 70 mm

LSR – 70 x 70 mm

Cabo com acabamento aborrachado

160



B

ECologic

Salvy — 93969

Conjunto de 2 talheres para salada em bambu. Food grade.

300 x 60 mm

LSR – 140 x 13 mm

ECologic

Lestini — 94110

Suporte para facas em madeira de pinho. Incluso conjunto de 5 facas de cozinha: faca utilitária média, faca utilitária pequena, faca para vegetais, faca para pão e faca para carne. Peças em aço inox e PP, cabo com acabamento emborrachado. Próprio para contato com alimento.

150 x 310 x 85 mm

LSR – 70 x 70 mm



C



160

160



ecologic



Koerper — 94111

Kit churrasco em caixa de bambu. Composto por 4 utensílios em aço inox e bambu: faca japonesa, faca chefe, faca boning e garfo. Food grade.

Caixa: 350 x 179 x 29 mm

LSR - 70 x 70 mm

NEW

ecologic



Marjoram — 94261

Tábua de corte em bambu. Food grade. Fornecido com caixa presente de papel craft.

400 x 300 x 15 mm

LSR - 70 x 9 mm

Convívios em casa

Leve a sua marca para os almoços de família ou jantares de amigos.



ecologic

Malvia — 93975

Tábua de queijos em bambu com faca incluída. Food grade. Fornecido em caixa presente de papel craft.

300 x 260 x 15 mm | Caixa: 307 x 267 x 21 mm

LSR - 150 x 50 mm



ecologic

Palermo — 93976

Tábua de queijos em bambu e aço inox com 3 talheres. Fornecida em caixa de cartão. Food grade.

330 x 195 x 16 mm | Caixa: 335 x 205 x 30 mm

LSR - 100 x 20 mm



ecologic

Woods — 93830

Tábua de queijos em bambu com 2 utensílios em bambu e aço inox. Food grade. Fornecido em caixa presente de papel craft.

310 x 180 x 15 mm | Caixa: 316 x 186 x 25 mm

LSR - 90 x 90 mm





B

NEW

ecologic



Cappero — 94028

Conjunto com tábua de corte e pequena faca de queijo em bambu. Food grade. Fornecido em caixa presente de papel craft.

☿ 143 x 200 x 10 mm |
Caixa: 150 x 205 x 32 mm
/ LSR – 50 x 6 mm



ecologic

B



160

ecologic



Capers — 93966

Tábua de servir em bambu. Food grade.

☿ 200 x 143 x 9 mm
/ LSR – 140 x 90 mm



160

ecologic



Banon — 93880

Tábua de servir em bambu. Food grade.

☿ 300 x 200 x 9 mm
/ LSR – 140 x 90 mm



NEW

ECologic



Monco — 92836

Sacola para pão 100% algodão (100 g/m²) com cordão para fechar.

∓ 220 x 560 mm

↗ LSR - 150 x 280 mm

Com suporte para copo



160

ECologic



Fabris — 93829



Prato em bambu com suporte para copo. Ideal para servir aperitivos. Food grade. Fornecido em luva de cartão.

∓ 200 x 147 x 13 mm | Manga: 160 x 148 x 14 mm

↗ LSR - 70 x 70 mm

Essenciais de cozinha

Dois reservatórios



110

NEW



Charles — 93875

Galheteiro em vidro que contém dois reservatórios com capacidades de até 50 ml e de até 250 ml. O galheteiro contém duas rolhas de cortiça. Food grade. Fornecido em caixa presente.

∓ Ø57 x 155 mm | Caixa: 75 x 175 x 75 mm

↗ PDP - 11 x 50 mm



127



Smartpepper — 93989

Salheiro ou pimenteiro em aço inox.

∓ Ø27 x 153 mm

↗ LSR - 30 x 8 mm

Até 1 hora

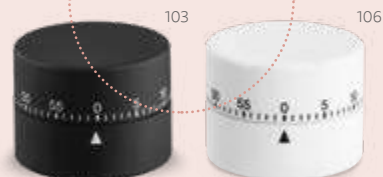

103

106

Montigny — 97389

Temporizador de cozinha em ABS e com acabamento emborrachado.

∓ Ø59 x 45 mm

↗ SCR - Ø40 mm



ecologic

Mustard — 93861

Travessa em bambu, indicada para servir alimentos. Fornecida em caixa de cartão. Food grade.

☿ 255 x 130 x 18 mm | Caixa: 260 x 134 x 26 mm

➤ LSR - 100 x 50 mm



160

• Fita para pendurar



160



ecologic

Sesame — 93831

Tábua em bambu ideal para servir aperitivos, com fita para pendurar. Fornecida em luva de cartão. Food grade.

☿ 420 x 134 x 9,6 mm | Manga: 200 x 135 x 10 mm

➤ LSR - 90 x 90 mm



100

ecologic

Pickled — 93885

Base de mesa em bambu com 3 potes em silicone. Fornecida em caixa craft. Food grade.

☿ Taças: 87 x 87 x 50 mm | Base: 300 x 105 x 9 mm | Caixa: 310 x 110 x 28 mm

➤ LSR - 140 x 15 mm



100

ecologic

Paprika — 93898

Base de mesa em bambu com 2 potes retráteis em silicone. Fornecido em caixa de papel craft. Food grade.

☿ Taças: 87 x 87 x 50 mm | Base: 347 x 168 x 19 mm | Caixa: 355 x 175 x 30 mm

➤ LSR - 60 x 40 mm



Mestre do churrasco

Kits com utensílios essenciais para preparar um excelente churrasco para a família e amigos.



103

Garlic King — 94142

  Kit churrasco em estojo de 210D. Composto por tábua em bambu e 5 utensílios em aço inox e madeira de Seringueira: faca chefe, faca média, pinça, garfo e afiador. Próprio para contato com alimento.



 Estojo: 350 x 230 x 40 mm |
Tábua: 300 x 230 x 12 mm

 TRS – 250 x 150 mm



103

Moussaka — 94107

  Kit churrasco em estojo de 210D. Composto por tábua em bambu e 3 utensílios em aço inox e madeira de Seringueira: faca japonesa, garfo e afiador. Próprio para contato com alimento.

 Estojo: 220 x 345 x 30 mm |
Tábua: 300 x 200 x 11,6 mm

 TRS – 200 x 120 mm



103

Garlic — 94145

 Kit churrasco em estojo de 210D. Composto por 3 utensílios em aço inox e madeira de Seringueira: faca chefe, pinça e garfo. Próprio para contato com alimento.

 Estojo: 350 x 130 x 20 mm

 TRS – 280 x 60 mm



103



Teriyaki — 94104

Kit churrasco em estojo de PU e 210D. Composto por tábua em bambu e 7 utensílios em aço inox e madeira de Seringueira: faca japonesa, faca chefe, garfo, pinça, faca pequena, afiador e pincel. Próprio para contato com alimento.

Estojo: 250 x 370 x 45 mm | Tábua: 300 x 200 x 11,6 mm

TR5 – 200 x 120 mm



ECÓlogic

A



Alioli King — 94140

Kit churrasco em caixa craft. Composto por 4 peças em aço inox e bambu: faca chefe, faca japonesa, garfo e pinça. Próprio para contato com alimento.

Caixa: 365 x 200 x 55 mm

LSR – 30 x 12 mm



ECÓlogic



Alioli Board — 94143

Kit churrasco em caixa craft. Composto por tábua em bambu e 2 utensílios em aço inox e bambu: faca chefe e garfo. Food grade.

Caixa: 360 x 210 x 40 mm | Tábua: 300 x 200 x 12 mm

LSR – 30 x 10 mm



ECÓlogic



Alioli — 94139

Kit churrasco em caixa craft. Composto por 2 utensílios em aço inox e bambu: faca chefe e garfo. Próprio para contato com alimento.

Caixa: 340 x 115 x 25 mm

LSR – 30 x 12 mm



160



ecologic



Bottura — 93844



Kit churrasco em estojo de bambu. Composto por 6 peças em aço inox e bambu: faca chefe, faca média, faca japonesa, pinça, garfo e afiador. Food grade.



Estojo: 455 x 160 x 65 mm

LSR - 140 x 90 mm



103

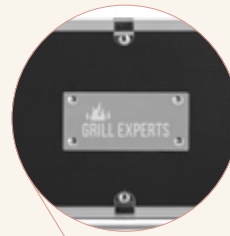

Valastro — 94109



Kit churrasco em estojo de alumínio. Composto por 5 utensílios em aço inox e alumínio: faca chefe, faca japonesa, faca boning, garfo e afiador. Próprio para contato com alimento.

Estojo: 385 x 120 x 69 mm | Placa: 75 x 35 mm

LSR - 60 x 20 mm



127



127



Mace — 93845



Kit churrasco em estojo de alumínio. Composto por luva de cozinha em poliéster e 6 utensílios em aço inox: faca chefe, 1 faca japonesa, 1 pinça, 1 garfo, 1 espátula e 1 afiador. Próprio para contato com alimento.

Estojo: 450 x 170 x 80 mm | Placa: 80 x 50 mm

LSR - 50 x 30 mm

Annatto — 94141



Kit churrasco em estojo de alumínio. Composto por 4 utensílios em aço inox: faca chefe, pinça, garfo e espátula. Próprio para contato com alimento.

Estojo: 385 x 110 x 80 mm | Placa: 60 x 30 mm

LSR - 50 x 20 mm



 **Champ** — 94112

 Kit churrasco composto por 4 utensílios: faca, garfo e pinça em aço inox e madeira de Seringueira e uma luva de cozinha. O estojo dobrável em 600D pode ser convertível em avental para sua proteção. Próprio para contato com alimento.

 Dobrado e fechado: 130 x 480 mm.

 **TRS** – 140 x 95 mm

Kit 2 em 1, convertível em avental e com os utensílios necessários para os melhores grelhados





Cubat — 94138

Kit churrasco em estojo de 210D. Composto por 2 utensílios em aço inox e madeira Seringueira: faca chefe e garfo. Próprio para contato com alimento.

Estojo: 350 x 130 x 20 mm

TR5 - 280 x 60 mm



Durand — 94136

Kit churrasco em estojo de 210D. Composto por 2 utensílios em aço inox: faca chefe e garfo. Próprio para contato com alimento.

Estojo: 350 x 130 x 20 mm

TR5 - 280 x 60 mm



Jullemier — 94137

Kit churrasco em estojo de 210D. Composto por 2 utensílios em aço inox e PP: faca chefe e garfo. Próprio para contato com alimento.

Estojo: 350 x 130 x 20 mm

TR5 - 280 x 60 mm



Ravioli — 94102

Kit churrasco em estojo de 210D com peças em aço inox e PP. Composto por tábua em PP e 3 utensílios: faca chefe, garfo e afiador. Próprio para contato com alimento.

Estojo: 220 x 345 x 30 mm |
Tábua: 195 x 285 x 5 mm

TR5 – 200 x 120 mm



Botaly — 94144

Kit churrasco em estojo de nylon 210D. Composto por tábua em PP e 5 utensílios em aço inox e PP: faca chefe, faca boning, faca pequena, garfo e afiador. Próprio para contato com alimento.

Estojo: 350 x 230 x 40 mm |
Tábua: 283 x 192 x 5 mm

TR5 – 250 x 150 mm

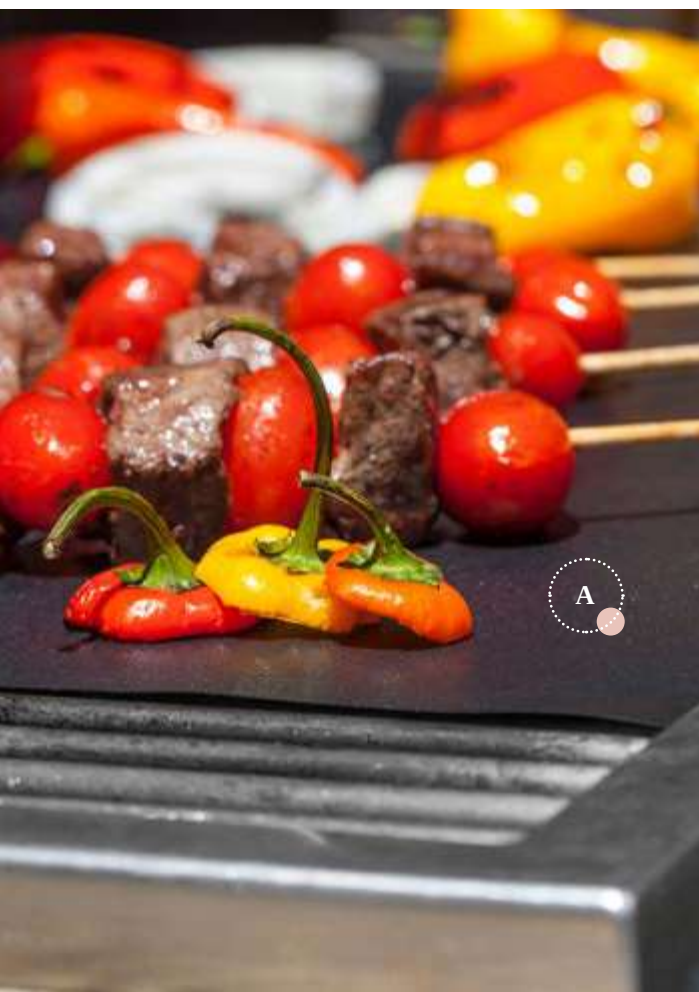

A

Inclua no seu kit de churrasco esta esteira. Eleve seus grelhados

Chives
99822
R\$.284



103

A



Atala — 94101

Esteira para grelha em PTFE. Indicada para colocar em cima das grelhas de churrasco para que a comida não grude.

400 x 300 mm





Vedante em silicone

NEW



Portobello — 94781

Marmita em vidro borossilicato e tampa em bambu com vedante em silicone. Apto para o microondas e máquina de lavar, retirando a tampa. Capacidade até 1L. Food grade. Fornecida em caixa presente de papel craft.

196 x 145 x 64 mm | Caixa: 202 x 150 x 66 mm

LSR - 120 x 80 mm

Válvula de duas posições



NEW



Reina — 93850

Marmita em vidro borossilicato com tampa em PP e capacidade até 600 ml. A tampa incorpora uma válvula de duas posições (aberta e fechada). Apta para máquina de lavar louça e microondas (retirando a tampa).

175 x 62 x 131 mm

PDP - 50 x 30 mm



Comida caseira

Torne as suas rotinas mais sustentáveis e leve refeições preparadas em casa.



York
98428

📦 .315



NEW

EcoLogic

Shino — 94025

800 ml



Marmita em aço inox e tampa em bambu com banda elástica para um transporte mais seguro. Capacidade até 800 ml. Food grade. Fornecida em caixa de papel craft.

📏 165 x 115 x 52 mm

📏 LSR – 140 x 90 mm

160



• Com elástico para um transporte seguro



B



A



A

700 ml

NEW

ecologic



Spice 700 — 94079

Frasco em vidro borossilicato e tampa de cortiça. Capacidade até 700ml. Food grade. Fornecido em caixa presente de papel craft.

± Ø95 x 110 mm

LSR - Ø70 mm



B

380 ml

NEW

ecologic



Spice 380 — 94099

Frasco em vidro borossilicato e tampa de cortiça. Capacidade até 380ml. Food grade. Fornecido em caixa presente de papel craft.

± Ø95 x 60 mm

LSR - Ø70 mm



C

1L

NEW

ecologic



Jasmin 1000 — 94236

Squeeze em vidro borossilicato com tampa de cortiça. Capacidade até 1L. Food grade. Fornecido em caixa presente de papel craft.

± Ø83 x 215 mm

LSR - Ø55 mm



D

800 ml

NEW

ecologic



Jasmin 800 — 94235

Squeeze em vidro borossilicato com tampa de cortiça. Capacidade até 800 ml. Food grade. Fornecido em caixa presente de papel craft.

± Ø80 x 190 mm

LSR - Ø50 mm





160

ECologic



Hibiscus — 93978



Caixa de chás em bambu, com 4 compartimentos e fecho com ímã. Fornecido em caixa presente de papel craft.



∓ 160 x 160 x 78 mm |
Caixa kraft: 166 x 166 x 85 mm

↗ LSR - 140 x 140 mm



160

ECologic



Verbena — 93977



Caixa de chás em bambu, com 2 compartimentos e fecho com ímã. Fornecida em caixa presente de papel craft.



∓ 160 x 87 x 78 mm | Caixa kraft: 166 x 91 x 87 mm

↗ LSR - 140 x 70 mm

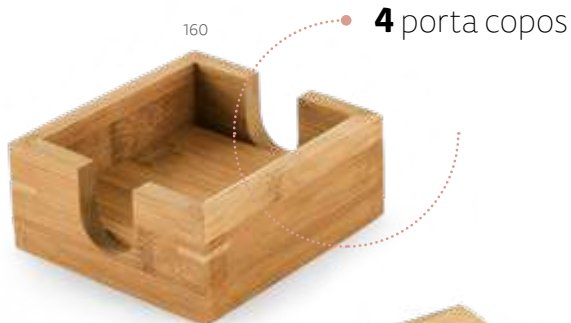

160

4 porta copos



ECologic



Gauthier — 93967

Conjunto de 4 porta copos em bambu com caixa aberta. Fornecido em caixa presente de papel craft.

∓ 115 x 115 x 35 mm |
Base copo: 100 x 100 x 6 mm |
Caixa: 119 x 121 x 56 mm

↗ LSR - 80 x 80 mm



160



NEW

ECologic



Pisani — 93828

Porta copos redondo em cortiça.

∓ Ø100 x 5 mm

↗ LSR - Ø70 mm



160

ECologic



Garcia — 93827

Porta copos em cortiça em formato quadrado com cantos arredondados.

∓ 100 x 100 x 5 mm

↗ LSR - 80 x 80 mm



160

ecologic

Moreto — 94119

Conjunto para vinho com 4 peças em madeira e metal: saca-rolhas com canivete de sommelier, gargantilha, salva-gotas com tampa e rolha. Fornecido em caixa presente em cortiça.

∓ Ø144 x 42 mm

↗ LSR - Ø90 mm



170

• Com sistema de mola para extração em duas fases



NEW

Inox Chaptal — 94243

Saca-rolhas em madeira e aço inox. Com sistema de mola para extração em duas fases. Com canivete de escanção.

∓ 120 x 28 x 13 mm

↗ LSR - 15 x 5 mm



160

ecologic

Cabernet — 94190

Conjunto para vinho em bambu e zinco. Incluso saca-rolhas com canivete de sommelier, termômetro, rolha e gargantilha.

∓ 147 x 167 x 54 mm

↗ LSR - 120 x 90 mm



160

ecologic

Syrah — 94189

Conjunto para vinho em bambu e zinco. Incluso saca-rolhas com canivete de sommelier, gargantilha, salva-gotas com tampa e rolha.

∓ 363 x 112 x 119 mm

↗ LSR - 140 x 90 mm



B

A

“New
vament”



NEW

Merlot — 94249

Saca rolhas elétrico em ABS com 4 pilhas AA inclusas. Inclui corta-cápsulas. Fornecido em caixa presente.

☿ Saca rolhas: Ø48 x 230 mm | Caixa: 54 x 54 x 250 mm

🔪 PDP – 30 x 15 mm



Saca rolhas elétrico



NEW

Winery — 94248

Conjunto de saca rolhas elétrico e acessórios em ABS e TPE. Incluso corta cápsulas, rolha de vácuo e salva-gotas. Com pilhas incluídas. Fornecido com caixa presente.

☿ Saca rolhas: 45 x 227 mm | Caixa: 241 x 90 x 54 mm

🔪 PDP – 20 x 15 mm



Saca rolhas elétrico

Inclui corta cápsulas, rolha de vácuo e vertedor de vinho anti-gota



127

Barrel — 94191

Conjunto para vinho em zinco. Incluso saca-rolhas com canivete de sommelier e rolha. Fornecido em caixa presente.

☿ 103 x 133 x 28 mm

🔪 SCR – 100 x 75 mm



NEW

Blend — 94247

Manga refrigeradora em nylon com elástico nas laterais. Fornecido em caixa presente.

☿ 160 x 230 mm

🔪 TRS – 140 x 90 mm



103

Ideal para squeezez mais largas



103



Macabeu — 94193

Luva refrigeradora em nylon 190T com fecho em velcro.

∓ 326 x 230 mm

↗ TRS - 220 x 25 mm



110



Colombia — 94194

Sacola refrigeradora para 1 garrafa em PVC com alças de 35 cm.

∓ 100 x 250 x 100 mm

↗ SCR - 60 x 20 mm



103



Vermentino — 93892

Rolha de vácuo para garrafa em ABS. Food grade.

∓ Ø48 x 73 mm

↗ PDP - 10 x 40 mm



115



104



103

Baird — 92844

Sacola para 1 garrafa em non-woven (80 g/m²) com alças.

∓ 100 x 330 x 100 mm

↗ TRS - 60 x 230 mm



B

A



A

EcoLogic



Jerome — 92883

Sacola para garrafa 100% algodão (180 g/m²) com cordão para fechar, também em algodão.

150 x 340 mm

TR5 - 200 x 140 mm

160



160



B

EcoLogic



Borba — 92819

Sacola em cortiça para 1 garrafa. Sacola amiga do ambiente com 2 alças e janela na parte frontal, ideal para oferta.

100 x 330 x 100 mm

TR5 - 60 x 80 mm





Funfaye — 94116

Porta copos em ABS com abridor de garrafas e esponja antiderrapante na base.

☒ 82 x 82 x 4 mm
 ⚡ PDP — 30 x 25 mm

Esponja antiderrapante na base



Holz — 94134
 Abridor de garrafas em metal com cabo em madeira.
 ☒ 40 x 150 x 17 mm
 ⚡ LSR — 60 x 15 mm



Barley — 94118

Abridor de garrafas em alumínio.

☒ 39 x 83 x 4 mm
 ⚡ LSR — 30 x 10 mm



Malte — 94115

Abridor de garrafas com imã.

☒ 50 x 105 x 5 mm
 ⚡ PDP — 40 x 20 mm



Inox Malbec — 94117

Saca-rolhas em metal e PP com abridor de garrafas e canivete de sommelier. Espiral em aço inox.

☞ 121 x 20 x 12 mm

☞ PDP – 30 x 5 mm



Tanat — 94103

Saca-rolhas em metal com abridor de garrafas e canivete de sommelier.

☞ 110 x 25 x 10 mm

☞ LSR – 70 x 7 mm



Carin — 94114

Saca-rolhas em madeira com abridor de garrafas e canivete de sommelier.

☞ 109 x 25 x 8 mm

☞ LSR – 50 x 7 mm

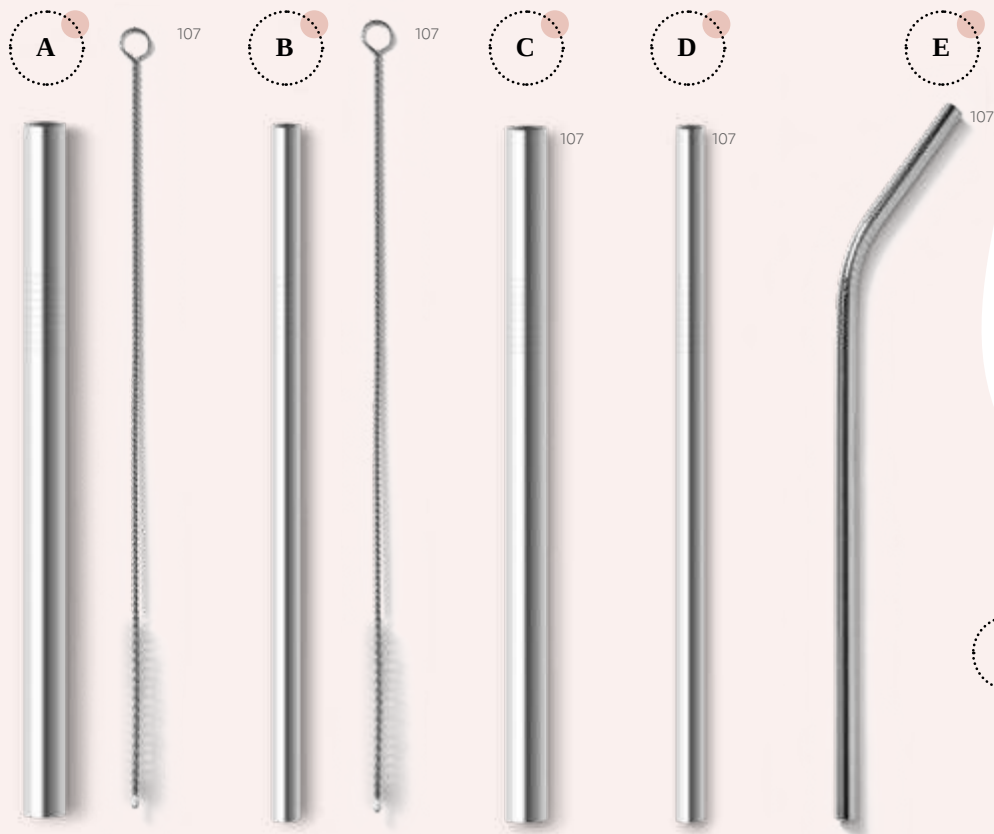

Mais responsabilidade

Ao optar por canudos reutilizáveis, está a manter os nossos oceanos mais limpos e a contribuir para um planeta mais sustentável.

Combine os canudos reutilizáveis com as bolsas 92918 + 92917

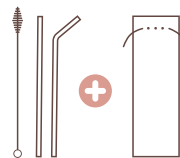

A  **Kahana Wide** — 94095

Canudo em aço inox. Food grade. Embalagem vendida opcionalmente: 92918 (bolsa em now-woven) ou 92917 (bolsa em linho).

☒ Canudo: Ø8 x 215 mm | Escova de limpeza: 240 mm
⚡ LSR – 60 x 5 mm

B  **Kahana** — 94096

Canudo em aço inox. Food grade. Embalagem vendida opcionalmente: 92918 (bolsa em now-woven) ou 92917 (bolsa em linho).

☒ Canudo: Ø6 x 215 mm | Escova de limpeza: 240 mm
⚡ LSR – 60 x 3,5 mm

C  **Aerial Wide** — 94094



Canudo em aço inox. Food grade. Embalagem vendida opcionalmente: 92918 (bolsa em now-woven) ou 92917 (bolsa em linho).

☒ Ø6 x 215 mm
⚡ LSR – 60 x 5 mm

D  **Aerial** — 94092

Canudo em aço inox. Food grade. Embalagem vendida opcionalmente: 92918 (bolsa em now-woven) ou 92917 (bolsa em linho).

☒ Ø6 x 215 mm
⚡ LSR – 60 x 3,5 mm

E  **Quiver** — 94093

Canudo em aço inox. Food grade. Embalagem vendida opcionalmente: 92918 (bolsa em now-woven) ou 92917 (bolsa em linho).

☒ Ø6 x 215 mm
⚡ LSR – 60 x 3,5 mm



Canudo dobrável em silicone



Canudo dobrável em silicone

NEW
 **Julep** — 94090

Canudo reutilizável e dobrável em 100% silicone. O canudo é acompanhado de uma caixa PP translúcida com acabamento fosco permitindo a sua portabilidade.

☒ Palhinha: Ø7 x 250 mm | Caixa: Ø55 x 20 mm
⚡ PDP – Ø30 mm

NEW
Drinky — 94091

Canudo reutilizável e dobrável em 100% silicone. O canudo é acompanhado de uma caixa PP branca e translúcida com acabamento fosco.

☒ Canudo: Ø7 x 250 mm | Caixa: Ø55 x 20 mm
⚡ PDP – Ø25 mm



A



A

NEW

Inox **Bramble** — 94043

Set de cocktail com 6 peças em aço inoxidável: um shaker (600 + 450 ml), um copo dosador (30 ml), uma colher, um pilão e um coador. Inclui uma bolsa em non-woven. Fornecido em caixa presente.

Caixa: 98 x 98 x 290 mm

LSR – 225 x 30 mm

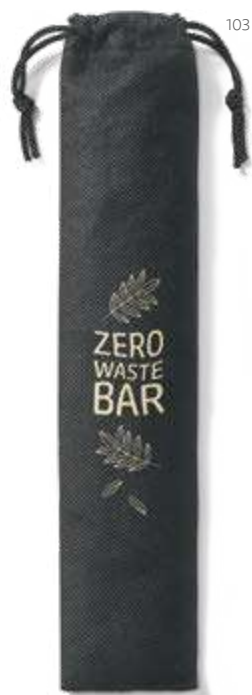

103

Kitan — 92918

Bolsa pequena em non-woven.

Caixa: 60 x 265 mm

LSR – 160 x 30 mm



150

Charon — 92917

Bolsa pequena em linho.

Caixa: 60 x 265 mm

LSR – 160 x 30 mm



103

104

Palhinha telescópico

Inox **Zamba** — 94057

Conjunto de canudo em aço inox e escova de limpeza. Fornecido em estojo com mosquetão. Food grade.

Canudo: Ø9 x 218 mm | Estojo: Ø10 x 105 mm

SCR – 55 x 40 mm



Lamone — 94098

Conjunto de 10 canudos de uso único em papel craft. Fornecidos em caixa de papel craft.

Canudo: Ø6 x 196 mm | Caixa: 33 x 200 x 14 mm

SCR – 20 x 90 mm



Suya — 94077

Conjunto de talheres descartáveis em madeira composto por: garfo, faca e colher. Incluso guardanapo em craft. Fornecido em bolsa de papel craft.

62 x 216 mm

STI – 45 x 60 mm

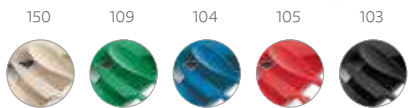

Tahini — 94055

Conjunto de 3 talheres em fibra de bambu (50%) e PP (50%) com garfo, faca e colher. Incluso estojo.

Food grade.

205 x 65 x 25 mm

PDP – 60 x 25 mm

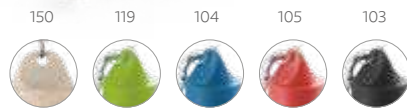

Lynne — 94056

Conjunto de canudo em fibra de bambu e escova de limpeza. Fornecido em estojo com mosquetão. Food grade.

Canudo: Ø8 x 225 mm | Estojo: Ø13 x 124 mm

SCR – 55 x 40 mm



Valley — 94068

.350



105

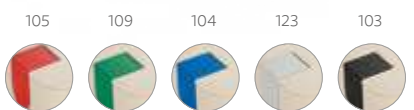

D **Alsi** — 94051
 Marmita hermética em fibra de bambu (50%) e PP (50%) com um compartimento com capacidade até 1 L. Contém suporte para celular. Apto para microondas (retirar a tampa). Food grade.
 195 x 114 x 60 mm
 SCR — 80 x 50 mm



104

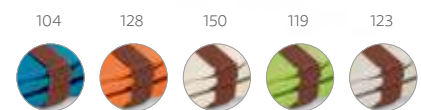

E **Canola** — 94053
 Marmita hermética em fibra de bambu (50%) e PP (50%) com compartimento com capacidade até 600 ml. Contém banda elástica com suporte para 2 talheres, inclusos: garfo e faca. Apto para microondas (retirar a tampa). Food grade.
 165 x 111 x 50 mm
 SCR — 80 x 50 mm

Marmitas ajustáveis

Aumente ou diminua o tamanho da sua marmita e organize as porções de alimentos de acordo com a sua necessidade.



• 2 compartimentos

+750 ml



Dill — 93848

Marmita hermética retrátil em silicone e PP com dois compartimentos com capacidades até 480 ml e 760 ml. No topo da tampa tem um encaixe com um talher (incluso) com função 2 em 1, garfo e colher.

Apta para microondas (retirar a tampa). Food grade.

∓ 212 x 153 x 73 mm | Dobrada: 212 x 153 x 38 mm

➤ PDP – 50 x 20 mm

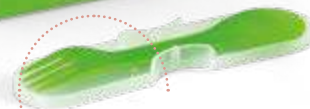

Talher **2 em 1**, garfo e colher



+600 ml



Saffron — 93847

Marmita hermética retrátil em silicone e PP com um compartimento com capacidade até 640 ml. No topo da tampa tem um encaixe com um talher (incluso) com função 2 em 1, garfo e colher. Apta para microondas (retirar a tampa). Food grade.

∓ 170 x 110 x 66 mm | Dobrada: 170 x 110 x 40 mm

➤ PDP – 50 x 20 mm



A

1,2l



Cilantro — 93854

Marmita em PP com 3 compartimentos e capacidade até 1.200 ml. Apta para microondas (retirar a tampa). Incluso garfo, faca e molheira. Food grade.

∓ 175 x 175 x 87 mm

➤ PDP – 50 x 25 mm



Recipiente térmico para comida com dupla parede



B



C

Alça para transporte em silicone



NEW

B



Samoura — 93851

Recipiente térmico em PP com parede dupla. Com pega para transporte em silicone, ideal para refeições. Food grade. Capacidade até 380 ml

380 ml

∓ 90 x 105 mm

➤ PDP - Ø40 mm



Combine esta marmitta com nossa caixa de oferta



C



Bocuse — 93853

+ 93852 .358

Marmitta em PP e PS com 2 compartimentos (680 ml cada) e 1 divisória removível. Incluso 3 talheres: garfo, faca e colher. Fecha com banda elástica e está apta para microondas (retirar a tampa). Food grade. Caixa branca 93852 vendida opcionalmente.

+650 ml

∓ 180 x 100 x 100 mm

➤ SCR - 140 x 60 mm



Quadrado liso para personalização

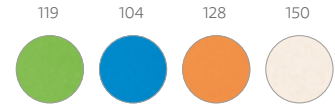

- Lippia** — 94780
- Tábua de corte em fibra de bambu (50%) e PP (50%). Contém um quadrado liso no fundo da tábua, adequado para a personalização. Food grade.
 - 237 x 140 x 4 mm
 - HTS – 35 x 35 mm



- Tokev** — 93870
- Cortador de pizza com abridor de garrafas. Food grade.
 - 132 x 63 x 8 mm
 - PDP – 35 x 25 mm



- Tarragon** — 93899
- 800 ml
 - Marmita em PP com capacidade até 800 ml. Apta para microondas. Food grade.
 - 180 x 125 x 58 mm
 - SCR – 100 x 100 mm



Apropriado para comida

Procure este símbolo nos nossos produtos apropriados para contato com alimentos



850 ml



Turmeric — 53878

+ 94659 358

Copo para salada em PP com garfo e molheira. Capacidade até 850 ml. Apto para microondas (retirar a tampa). Food grade. Caixa branca 94659 vendida opcionalmente.

∅110 x 190 mm

PDP - 30 x 20 mm

Inclui garfo e molheira



103



103

160



NEW

ecologic



Zimbro — 99812

Avental com algodão reciclado (140 g/m²) e bolso frontal.

☒ 590 x 900 mm | Bolso: 250 x 200 mm

🔪 TRS – 200 x 240 mm



106

103

104

Chives — 99822

Avental em algodão e poliéster (150 g/m²) com fitas de ajuste e com 2 bolsos frontais.

☒ 650 x 900 mm |

Bolso int.: 80 x 140 mm |

Bolso ext.: 250 x 160 mm

🔪 TXP – 200 x 200 mm



106



103



104



104

105

106

103

Ginger — 99830

Avental em algodão e poliéster (150 g/m²) com 2 bolsos frontais. Ajustável com fivela.

☒ 650 x 850 mm |

Bolso: 170 x 180 mm

🔪 TXP – 200 x 230 mm

Naecker — 99824

Avental de bar em algodão e poliéster (145 g/m²), com 2 bolsos.

☒ 960 x 800 mm |

Bolso: 145 x 200 mm

🔪 TRS – 280 x 130 mm



Tira lateral para suporte de pano de cozinha



NEW

ecologic

Bosi — 99814

Avental em 100% algodão canvas (320 g/m²) com detalhes em metal. Com 3 bolsos multifuncionais e uma tira lateral (para suporte de um pano de cozinha). Tira do pescoço facilmente ajustável.

▮ 680 x 900 mm

➤ TRS – 200 x 200 mm



150



Avental 100% algodão com design elegante e funcional



Com 3 bolsos multifuncionais e uma tira lateral para suporte de pano de cozinha

Tira do pescoço facilmente ajustável



NEW

ecologic

Sunflower — 99813

Avental em 100% algodão canvas (300 g/m²) com detalhes em metal. Com 3 bolsos multifuncionais e uma tira lateral (para suporte de um pano de cozinha). Tira do pescoço facilmente ajustável.

▮ 680 x 900 mm

➤ TRS – 200 x 200 mm



104

103



104



B



NEW

ECologic

Chicory — 99835

Avental multiusos em lona de algodão (260 g/m²) com 3 bolsos frontais e fita para amarrar à cintura.

☒ 580 x 375 mm

✂ TRS – 140 x 90 mm



Descubra um novo passatempo

A jardinagem pode ser uma ótima opção para passar mais tempo no exterior e relaxar a mente



NEW

ecologic

 **Orchid** — 98129

Conjunto de jardinagem com 3 ferramentas em metal e madeira de eucalipto: pá, rastelo e garfo. Inclui bolsa 100% algodão (180 g/m²) com fita para fechar. Fornecido desmontado.

☿ Bolsa: 130 x 600 mm | Pá: 60 x 254 mm | Ancinho: 63 x 215 mm | Forquilha: 57 x 245 mm

♣ TRS – 280 x 200 mm



Manta reversível



Heiden — 99078

Manta reversível em tecido polar 190 g/m² acetinado com forro sherpa (225 g/m²), para um maior conforto. Inclui na parte do forro um zíper para permitir facilmente a impressão. É fornecida com uma fita em cetim com velcro e um cartão personalizável.

☒ Manta: 1500 x 1200 mm | Fita de cetim : 750 x 40 mm | Cartão: 160 x 130 mm

🔪 SCR – 100 x 100 mm



Warmy — 99071

Manta em tecido polar (250 g/m²), com fita acetinada e cartão para personalização.

☒ 1600 x 1300 mm | Cartão: 160 x 140 mm

🔪 TRS – 280 x 200 mm



Tratamento antiborboto



Dyleaf — 99075

Manta em tecido polar (240 g/m²) com acabamento aveludado e tratamento anti-pilling. Inclui uma fita acetinada e cartão para personalização.

☒ 1500 x 1200 mm | Cartão: 160 x 130 mm

🔪 SCR – 100 x 100 mm



Sulena — 99051

Manta em tecido polar (180 g/m²), disponível em várias cores.

☒ 1450 x 950 mm

🔪 TRS – 200 x 280 mm



**Sacolas &
Bolsas Térmicas**





Bolso interior

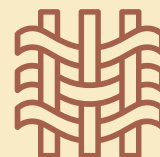

Juco: o novo tecido ecológico

A combinação entre o algodão e a juta resulta num material de alta durabilidade e resistência: o Juco. Um tecido sustentável, versátil e cada vez mais presente no nosso dia a dia.



Marbella
92938

 .197



NEW

EcoLogic



Padova — 92937

Sacola em juco (275 g/m²) com bolso interior 100% algodão (120 g/m²) com fecho e alças de 60 cm. Pegas em webbing de algodão bicolor.

☒ 370 x 410 x 90 mm

🔪 TRS - 140 x 45 mm



Juta e algodão



ECologic



Sablón — 92919

Sacola tipo mochila 100% algodão (160 g/m²) com detalhe em imitação de juta e alça em algodão.

☒ 370 x 410 mm

✂ TXP – 240 x 200 mm



ECologic



Mercat — 92882

Sacola 100% algodão (160 g/m²) com detalhe em imitação de juta e alças de 65 cm.

☒ 375 x 415 mm

✂ TXP – 270 x 200 mm



160



160



160

ECologic



Tizzy — 92828

Sacola de compras em juta (360 g/m²) com laminado no interior e com alças webbing com 60 cm.

☒ 385 x 445 x 165 mm

➤ TRS – 270 x 200 mm

D

ECologic



Braga — 92823

Sacola em juta (240 g/m²) com alças de 65 cm e um bolso frontal 100% algodão (140 g/m²).

☒ 370 x 410 x 100 mm |

Bolso: 370 x 270 mm

➤ TXP – 200 x 150 mm

C

ECologic



Shanti — 92827

Sacola de compras em juta (360 g/m²) com laminado no interior e com alças curtas acolchoadas.

☒ 430 x 340 x 175 mm

➤ TRS – 230 x 160 mm



Sacolas 100% algodão

De origem orgânica, esta fibra 100% natural permite a criação de peças autênticas, de qualidade e de grande durabilidade.



A



Alças em cortiça

160

ECologic

Feria — 92869

Sacola 100% algodão (180 g/m²) com alças de 60 cm em cortiça e com bolso interior.

‡ 450 x 400 x 105 mm

▲ TXP - 270 x 230 mm

A



150



Dobrável

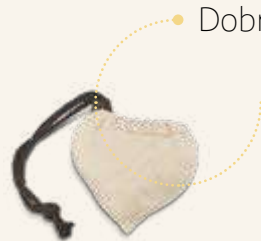

B

ECologic

Orleans — 92922

Sacola dobrável 100% algodão (100 g/m²). Fornecida desdobrada.

‡ 370 x 400 mm

▲ TXP - 250 x 200 mm



B



Parte da frente em rede



NEW

ECÓlogic

Napoli — 92935

Sacola 100% algodão (120 g/m²) com malha 100% algodão na parte frontal (100 g/m²) e cordões em algodão para fechar. Sacola ideal para levar alimentos.

300 x 400 mm

TR5 - 200 x 280 mm



ECÓlogic

Mumbai — 92927

Sacola 100% algodão (180 g/m²) com malha 100% algodão na parte frontal. Alças em webbing com 65 cm. Sacola ideal para compras.

390 x 430 x 80 mm

TR5 - 200 x 50 mm

Parte da frente em rede





Alças de **75** cm



EcoLogic

Bondi — 92821
Sacola 100% algodão (140 g/m²)
com alças de 60 cm.
▮ 375 x 415 mm
▮ **TXP** – 270 x 260 mm



EcoLogic

Regent — 92414
Sacola 100% algodão (100 g/m²)
com alças de 75 cm.
▮ 370 x 410 mm
▮ **TXP** – 270 x 250 mm



EcoLogic

Victoria — 92415
Sacola 100% algodão (100 g/m²)
com alças de 30 cm.
▮ 370 x 410 mm
▮ **TXP** – 270 x 250 mm



EcoLogic

Wharf — 92902
Sacola 100% algodão (100 g/m²)
com alças de 75 cm.
▮ 370 x 410 mm
▮ **TXP** – 270 x 250 mm



EcoLogic

Kolonaki — 92826
Sacola 100% algodão (140 g/m²)
com alças de 60 cm.
▮ 375 x 415 mm
▮ **TXP** – 270 x 230 mm





150

ECÓlogic

Marvay — 92825

Sacola 100% algodão (180 g/m²) com alças de 65 cm.

▮ 460 x 400 x 105 mm

▮ TXP – 270 x 220 mm



Bolso interior com fecho

ECÓlogic

Hackney — 92926

Sacola 100% algodão (280 g/m²) com fecho e bolso interior. Alças em algodão webbing com 65 cm.

▮ Sacola: 480 x 400 x 150 mm | Bolso interior: 180 x 140 mm

▮ TRS – 280 x 200 mm



150



A

Bolso interior



150

A

ECÓlogic

Beto — 92820

Sacola 100% algodão canvas (280 g/m²) com bolso interior e alças de 65 cm.

▮ 450 x 380 x 105 mm

▮ TXP – 270 x 230 mm



Sacolas 100% algodão



109
Fecho magnético



ECologic



Ville — 92824

Sacola 100% algodão canvas (280 g/m²) com bolso frontal e bolso interior com zíper. A sacola contém fecho magnético e alças de 60 cm.

▮ 530 x 380 x 170 mm

▮ TRS - 120 x 150 mm

Bolso interior



ECologic



Edmonton — 92822

Sacola 100% algodão canvas (280 g/m²) com bolso interior e alças de 65 cm.

▮ 460 x 400 x 150 mm

▮ TXP - 260 x 200 mm

Bolso interior



ECologic



Bazar — 92879

Sacola 100% algodão (140 g/m²) com alças de 65 cm.

▮ 370 x 410 x 100 mm

▮ TXP - 270 x 240 mm





ecologic

Hanover — 92456

Sacola tipo mochila 100% algodão (103 g/m²).

☒ 370 x 410 mm

🔪 TXP – 270 x 250 mm

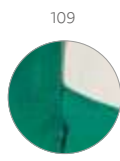

109

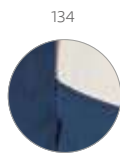

134

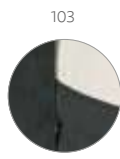

103



ecologic

Romford — 92913

Sacola tipo mochila 100% algodão (180 g/m²).

☒ 350 x 430 mm

🔪 TXP – 240 x 200 mm



103



106



105



114

ecologic

Ilford — 92914

Sacola tipo mochila 100% algodão.

☒ 370 x 410 mm

🔪 TXP – 270 x 230 mm



Algodão orgânico

Algodão proveniente de um cultivo sustentável, sem produtos químicos ou pesticidas.



160

ECologic



Nampula — 92933

Sacola tipo mochila 100% algodão orgânico (120 g/m²) proveniente de um cultivo sustentável, sem químicos ou pesticidas e etiqueta Label Organic.

▮ 370 x 410 mm

▮ TRS – 280 x 200 mm



160

ECologic



Matola — 92932

Sacola 100% algodão orgânico (120 g/m²) proveniente de um cultivo sustentável, sem químicos ou pesticidas. Alças de 60 cm e etiqueta Label Organic.

▮ 370 x 410 mm

▮ TRS – 280 x 200 mm



160



Sacola mochila
2 em 1



NEW

ecologic

 **Rissani** — 92936

Sacola tipo mochila com algodão reciclado (140 g/m²), alças de 30 cm e cordões em algodão para fechar.

☒ 370 x 410 mm

➤ TRS – 280 x 200 mm



Algodão reciclado

Uma ótima opção para reduzir o desperdício de têxteis e reaproveitar peças de roupa que já não usamos.



ecologic

 **Rynek** — 92920

Sacola em algodão reciclado (140 g/m²) com alças de 65 cm.

☒ 375 x 415 mm

➤ TXP – 270 x 230 mm



ecologic

 **Chancery** — 92928

Sacola tipo mochila em algodão reciclado (140 g/m²), com bolso frontal com fecho discreto e alças em algodão.

☒ 370 x 410 mm

➤ TRS – 280 x 200 mm

Bolso frontal com fecho discreto





PET Reciclado

Os fios criados a partir de rPET são uma ótima opção para tecer peças amigas do ambiente. Tal como o algodão reciclado, que permite o reaproveitamento de roupas velhas.



NEW

ecologic



Cairo — 92084

Sacola em algodão reciclado e rPET (180 g/m²) com alças de 65 cm.

380 x 420 mm

TXP – 300 x 300 mm



Sacolas de algodão reciclado

O algodão é um material orgânico proveniente de um cultivo sustentável, sem químicos ou pesticidas que permite tecer peças de qualidade, autênticas e de grande durabilidade.

NEW

EcoLogic



Mexico — 92323

Sacola em algodão reciclado e poliéster (140 g/m²) com alças de 65 cm.

☒ 380 x 429 mm

🔪 TXP - 300 x 300 mm



Feito de material reciclado



Feito de material reciclado



NEW

EcoLogic



Istanbul — 92083

Sacola tipo mochila em algodão reciclado e poliéster (140 g/m²).

☒ 370 x 410 mm

🔪 TXP - 300 x 300 mm



ecologic



Maputo — 92929

Sacola em rPET 190T. Produzida a partir de plástico reciclado contribuindo para a redução dos resíduos no meio ambiente. Alças de 60 cm.

☒ 380 x 420 mm

☒ TRS – 280 x 200 mm



ecologic



Pemba — 92931

Sacola tipo mochila em rPET 190T. Produzida a partir de plástico reciclado contribuindo para a redução dos resíduos no meio ambiente. Alças de 40 cm.

☒ 370 x 410 mm

☒ TRS – 280 x 200 mm





PET Reciclado

Após um processo de reciclagem, que não envolve a extração de petróleo, os fios criados a partir de rPET são trabalhados para tecer peças amigas do ambiente.

Dobrável



NEW

EcoLogic



Bolzano — 92934

Sacola dobrável em malha rPET com bolsa em rPET 190T para dobrar a sacola. Ideal para as compras.

☒ 320 x 400 mm

☒ TRS – 50 x 30 mm



Dobrável



EcoLogic



Beira — 92930

Sacola dobrável em rPET 190T. Produzida a partir de plástico reciclado contribuindo para a redução dos resíduos no meio ambiente. Alças de 40 cm.

☒ 370 x 420 mm

☒ TRS – 50 x 30 mm





114

Saída para fone de ouvido, fios ou cabos



114

106

108

119

A

Colmar — 92912

Sacola tipo mochila em 210D com bolso frontal com zíper e saída para fone de ouvido ou outros fios ou cabos.

☒ 350 x 400 mm

☒ TXP - 200 x 150 mm



A



119



119

114

105

103

Alicante — 92911

Sacola tipo mochila em 210D com bolso frontal e saída para fone de ouvido.

☒ 350 x 400 mm

☒ TXP - 140 x 180 mm

Elementos refletores



108



Bissaya
92617

☒ .379



108



128



Rules — 92835

Sacola tipo mochila em 210D, com elementos refletores. Produto promocional.

☒ 350 x 400 mm

☒ TXP - 250 x 160 mm

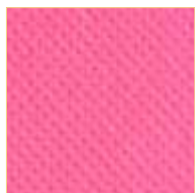

Boxp — 92904
 Sacola tipo mochila em non-woven (80 m/g²).
 370 x 410 mm
 TXP — 260 x 260 mm



Carnaby — 92910
 Sacola tipo mochila em 210D.
 350 x 410 mm
 TXP — 230 x 250 mm

Laminação
brilhante



Sawgrass — 92850

Sacola em non-woven laminado (90 g/m²) com alças de 50 cm e com laminação brilhante.

☒ 340 x 350 x 80 mm

✂ TXP – 220 x 250 mm

Laminação
brilhante



Memphis — 52856

Sacola em non-woven laminado (120 g/m²) com laminação brilhante. Alças em webbing de 60 cm.

☒ 420 x 320 x 150 mm

✂ TXP – 270 x 200 mm



Woodbury — 92832

Sacola em non-woven (80 g/m²) termo-selado com alças de 55 cm.

☒ 330 x 390 x 80 mm

✂ TXP – 200 x 250 mm



Dale — 92916

Sacola non-woven (80 g/m²) termo-selado com alças de 50 cm.

☒ 320 x 380 x 90 mm

✂ TXP – 200 x 280 mm

Ideal para viajar

O saco essencial para levar consigo na sua mala de viagem.



Arasta — 92924

Sacola em non-woven laminado brilhante (140 g/m²) com zíper. A sacola tem encaixe para trolley, fundo reforçado e alças em webbing de 65 cm.

☒ 350 x 350 x 200 mm

☒ TXP - 250 x 200 mm

Encaixe para trolley



Beacon — 92905

Sacola em non-woven (80 g/m²) termo-selado com alças de 55 cm.

☒ 480 x 380 x 85 mm

☒ TXP - 270 x 230 mm



Arleta — 92859

Sacola de compras em non-woven laminado (110 g/m²) com bolso frontal (175 g/m²).

☒ 381 x 330 x 200 mm

☒ TXP - 130 x 100 mm

Bolso frontal

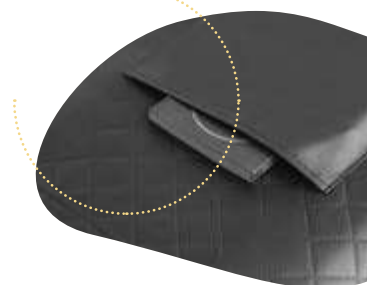



102



Canary — 92839

Sacola em non-woven (80 g/m²) termo-selado com alças de 75 cm.

☒ 380 x 415 x 85 mm

✂ TXP – 270 x 230 mm



124



Macy — 92854

Sacola em non-woven (80 g/m²) termo-selado com alças de 55 cm.

☒ 270 x 350 mm

✂ TXP – 160 x 220 mm



108



Stratford — 92499

Sacola em non-woven (80 g/m²) termo-selado.

☒ 355 x 390 x 85 mm

✂ TXP – 260 x 260 mm



119



Rotterdam — 92845

Sacola em non-woven (80 g/m²) termo-selado.

☒ 250 x 350 x 80 mm

✂ TXP – 160 x 200 mm

Sacolas dobráveis

Ideais para trazer consigo na mala, ir às compras ou transportar algo de última hora.



Bilbao — 92848

Sacola à tiracolo dobrável em 190T e alças de 75 cm. Fornecida dobrada.

☿ Dobrado: 105 x 105 mm | Aberto: 360 x 415 x 80 mm

✂ TXP – 150 x 200 mm



Covent — 92847

Sacola dobrável em non-woven (80 g/m²) com alças de 50 cm. Fornecida desdobrada.

☿ Dobrado: 110 x 132 x 20 mm |

Aberto: 360 x 410 x 80 mm

✂ TXP – 200 x 150 mm



Sacola térmica



Mayfair — 98423

Sacola térmica dobrável em 210D com alças em webbing de 60 cm, zíper e capacidade até 16 L. Fornecida desdobrada.

☿ 400 x 440 x 130 mm

✂ TXP – 130 x 100 mm



Pertina — 92998

Sacola dobrável em non-woven (80 g/m²) com alças de 65 cm. Fornecida desdobrada.

☿ Dobrado: 200 x 120 mm |

Aberto: 400 x 450 x 200 mm

✂ TXP – 270 x 230 mm



105

105



103



104



104

104



103



105

**Melville** — 98415

Bolsa térmica em 600D com zíper duplo, alça ajustável em webbing e bolso frontal. A bolsa tem capacidade até 12 L. Food grade.

☒ 290 x 340 x 190 mm

☒ TRS – 200 x 100 mm

**Luton** — 98414

Bolsa térmica em 600D com alça ajustável em webbing, bolso frontal e capacidade até 8 L. Food grade.

☒ 270 x 200 x 160 mm

☒ TRS – 200 x 55 mm



104



104



119



103

**Lolla** — 98417

Sacola térmica em 600D com zíper e compartimento exterior aberto forrado que contém um bolso frontal. Ideal para levar para a praia. Alças em webbing com 55 cm e capacidade até 9 L. Food grade.

☒ 470 x 305 x 120 mm

☒ TRS – 170 x 120 mm





Sacolas térmicas



A



A



Philadel — 98420

Sacola térmica em 600D com 2 formas distintas de utilização. Compartimento principal com zíper duplo e interior forrado em PEVA e almofadado. Contém bolso frontal com zíper e alças ajustáveis em webbing com reforço. A sacola tem capacidade até 15 L.

☒ 480 x 330 x 180 mm | 310 x 240 x 180 mm

➤ TRS - 150 x 45 mm

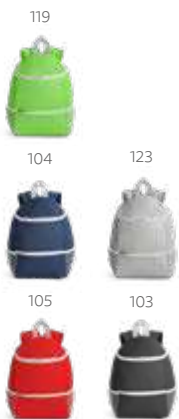

Jaipur — 98408

Mochila térmica em 600D com capacidade até 10 L. Inclui um bolso frontal com zíper e dois bolsos laterais em tela. Food grade.

☒ 280 x 340 x 140 mm

➤ TRS - 150 x 90 mm



Singapore — 98418

Bolsa térmica em 600D com alça ajustável em webbing, bolso frontal e capacidade até 9 L. Food grade.

☒ 240 x 220 x 170 mm

➤ TRS - 140 x 100 mm

Práticas & Versáteis

Seja para a praia ou para um piquenique, as sacolas térmicas flexíveis são uma grande ajuda para levar tudo o que necessita, enquanto mantém os alimentos frescos.



A



104

A



104



109



106



Baskit — 98426

Sacola térmica flexível em 600D com zíper duplo e interior forrado. Estrutura removível em alumínio, com pega ergonômica em EVA. Capacidade até 14 L.

∅ 460 x 270 x 250 mm

TRRS - 260 x 150 mm



116



116



104



113

B



Coast — 98425

Sacola térmica flexível em 600D com zíper duplo, interior forrado com PEVA e abridor de garrafas. Bolso superior com zíper, alças em webbing, com reforço e capacidade até 15 L. Food grade.

∅ 300 x 260 mm

TRRS - 90 x 80 mm



B



104



113



104



NEW

ECologic

C



Repurpose Cooler — 98427



Bolsa térmica em rPET 600D com interior em PEVA.

Alça ajustável em webbing, bolso frontal e fecho duplo.



Capacidade até 7 L.

↕ 240 x 170 x 170 mm

↗ TRS – 140 x 60 mm



Repurpose Backpack — 92080

📦 .174



Repurpose Sports — 92079

📦 .174



Repurpose Bag — 92078

📦 .205

• Fecho com velcro



160



D

NEW



York — 98428



Bolsa térmica até 4 L em papel com forro em non-woven e interior com isolamento térmico em alumínio. Fecho com velcro e bolso frontal.

↕ Fechado: 195 x 350 x 110 mm | Aberto: 195 x 410 x 110 mm

↗ TRS – 130 x 130 mm



D



119



Rotterdam — 98410

Sacola térmica em non-woven (80 g/m²) com fechamento em velcro e bolso frontal. Capacidade até 10 L. Food grade.

☒ 320 x 350 x 170 mm
☒ TRS – 120 x 150 mm



103



Jeddah — 98406

Bolsa térmica em 600D para 6 latas de 0.33 (capacidade até 3 L). Food grade.

☒ 200 x 140 x 125 mm
☒ TRS – 140 x 90 mm



106



Medan — 98411

Bolsa térmica em 600D com capacidade até 4 L. Food grade.

☒ 150 x 190 x 150 mm
☒ TRS – 90 x 90 mm



104



Osaka — 98413

Bolsa térmica dobrável em non-woven (80 g/m²) com fecho em velcro e com capacidade até 3 L. Food grade. Bolsa fornecida desdobrada.

☒ Dobrada: 170 x 95 x 40 mm |
Aberta: 170 x 265 x 110 mm
☒ TRS – 130 x 35 mm



108



Izmir — 98409

Bolsa térmica em non-woven (80 g/m²) com capacidade até 3L. Food grade.

☒ 200 x 140 x 130 mm
☒ TRS – 140 x 90 mm



Sebastian

98416

☒ .381



Turtle —

58412

☒ .381



Squeezes, Copos & Esporte



Materiais duráveis e sustentáveis

O modo como transportamos nossa bebida também pode ser mais sustentável. Materiais como o bambu conferem resistência e originalidade, tornando cada Squeeze único.





Parede dupla isolada a vácuo



Com infusor



103



160



NEW

A

ecologic



Laver — 94257

Squeeze em bambu e aço inox com corpo duplo, isolamento a vácuo e tampa em PP. Capacidade até 440 ml. Food grade. Fornecido em caixa presente de papel craft.

∅70 x 222 mm

Inox LSR – 25 x 140 mm



NEW

B

ecologic



Sow — 94239

Squeeze em bambu e aço inox, com corpo duplo e isolamento a vácuo. Capacidade até 440 ml. Food grade. Fornecido em caixa presente de papel craft.

∅70 x 215 mm

Inox LSR – 25 x 140 mm



A

Ecuador 250
94766
0.323

B



500 ml



NEW

ecologic

Pietro — 94241

Copo de viagem em bambu e aço inox, com sistema de abertura deslizante e parede dupla de isolamento. Capacidade até 500 ml. Food grade. Fornecido em caixa presente de papel craft.

Inox \pm Ø82 x 158 mm

LSR – 25 x 110 mm

• Tampa deslizante



NEW

ecologic

Lycka — 94761

Copo de bambu e aço inox de parede dupla isolada a ar e tampa AS com fecho deslizante. Capacidade até 350 ml. Food grade. Fornecido em caixa presente de papel craft.

Inox \pm Ø80 x 108 mm

DUV – 15 x 60 mm



2 infusores em aço inox



A

ecologic

Makarova — 94765

Squeeze em vidro de borossilicato com parede dupla e tampa em bambu. Incluso 2 infusores em aço inox. Capacidade até 490 ml. Apto para ir a máquina de lavar, removendo a tampa. Food grade. Fornecido em caixa presente de papel craft.

Inox \pm Ø72 x 234 mm

LSR – Ø50 mm

• Parede dupla isolada a vácuo



B

ecologic

Naturel — 94683

Squeeze em bambu e aço inox, com parede dupla isolada a vácuo e infusor para chá. Capacidade até 430 ml. Food grade. Fornecida em caixa.

Inox \pm Ø69 x 207 mm | Caixa: 72 x 210 x 72 mm

LSR – 20 x 130 mm





600 ml

107

Prensa francesa



Torne seus hábitos diários mais sustentáveis

Utilize copos de vidro para beber seu chá ou café da manhã.

NEW



Jenson — 94237

Cafeteira em vidro borossilicato e aço inox. Capacidade até 600 ml. Food grade. Fornecida em caixa.

∓ Ø95 x 170 mm

∕ LSR - Ø25 mm



110



NEW



Lunkina — 94768

Caneca em vidro com capacidade até 390 ml. Food grade. Fornecida em caixa.

∓ Ø91 x 103 mm

∕ PDP - 25 x 30 mm



106



NEW



Kenny II — 93804

Caneca em vidro com efeito fosco com capacidade até 340 ml. Fornecida em caixa.

∓ Ø80 x 97 mm |

Caixa: 120 x 88 x 102 mm

∕ PDP - Ø40 mm



110



NEW



Americano — 94785

Copo de vidro isotérmico com parede dupla isolada a ar e capacidade até 220 ml. Food grade. Fornecido em caixa de oferta personalizável.

∓ Ø80 x 86 mm

∕ PDP - 25 x 20 mm



110



NEW



Espresso — 93873

Conjunto de café em vidro isotérmico com 2 copos com parede dupla isolada a ar e capacidade até 75 ml. Fornecido em caixa presente personalizável.

∓ Caixa: 133 x 65 x 65 mm

∕ PDP - 25 x 10 mm

Infusor em aço inox

750 ml

160



A

NEW

ecologic



Snead — 94238

Bule de vidro borossilicato com tampa em bambu. Inclui infusor em aço inox. Capacidade até 750ml. Food grade. Fornecido em caixa presente de papel craft.

Inox
 200 x 85 mm
 LSR - Ø70 mm



B

Hibiscus
93978

.268



Verbena
93977

.268



160



NEW

ecologic

Ecuador 250 — 94766

Copo de viagem em vidro borossilicato com parede dupla isolada a ar e tampa em bambu. Copo com capacidade até 250 ml, ideal para líquidos frios ou quentes, tendo uma tampa com isolante em silicone que facilita o transporte do copo evitando respingo. Apto para ir ao microondas e à máquina de lavar, retirando a tampa. Food grade. Fornecido em caixa presente de papel craft.

Ø89 x 91 mm
 LSR - Ø60 mm



160

B



NEW

ecologic

Ecuador 350 — 94767

Copo de viagem em vidro borossilicato com parede dupla isolada a ar e tampa em bambu. Copo com capacidade até 350 ml, ideal para líquidos frios ou quentes, tendo uma tampa com isolante em silicone que facilita o transporte do copo evitando respingo. Apto para ir ao microondas e à máquina de lavar, retirando a tampa. Food grade. Fornecido em caixa presente de papel craft.

Ø91 x 119 mm
 LSR - Ø60 mm

Isolante em silicone para facilitar o transporte



Vidro borossilicato

Grande resistência e durabilidade. Ideal quer para altas temperaturas, quer para baixas temperaturas.

500 ml

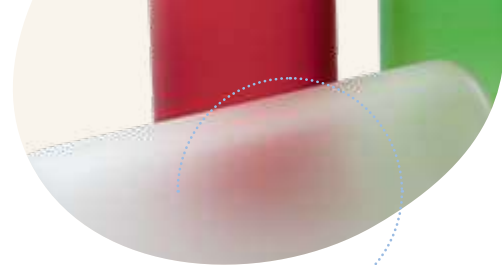

Acabamento fosco

NEW

Eco logic

Lillard — 94770

- Squeeze de vidro borossilicato fosco com tampa em bambu e capacidade até 500 ml. Food grade.
- Fornecido em caixa presente de papel craft.

∅ 65 x 190 mm
SCR - 120 x 120 mm

600 ml



Apto para bebidas quentes



Apto para bebidas frias

Eco logic

Dakar — 94699

- Squeeze em vidro borossilicato e com tampa em bambu.
- Revestido com luva em silicone. Capacidade até 600 ml.
- Food grade. Fornecido em caixa.

∅ 68 x 231 mm
PDP - 25 x 30 mm



A

1L

NEW

ECologic



Jasmin 1000 — 94236

Squeeze em vidro borosilicato com tampa de cortiça. Capacidade até 1L. Food grade. Fornecido em caixa presente de papel craft.

∅83 x 215 mm

LSR - ∅55 mm



B

800 ml

NEW

ECologic



Jasmin 800 — 94235

Squeeze em vidro borosilicato com tampa de cortiça. Capacidade até 800 ml. Food grade. Fornecido em caixa presente de papel craft.

∅80 x 190 mm

LSR - ∅50 mm



800 ml

B



1L

A



+ 500 ml



A



ecologic

Raise — 94646 + 94651 .358

Squeeze em vidro e aço inox com alça na tampa para facilitar o transporte. Capacidade até 520 ml. Fornecido com luva em soft shell. Food grade. Caixa branca 94651 vendida opcionalmente.

Ø65 x 225 mm

TRS - 40 x 120 mm



B



ecologic



Dhabi — 94668

Squeeze em vidro borossilicato com tampa em PP e bolsa em silicone. Capacidade até 380 ml. Food grade. Fornecida em caixa.

∅58 x 191 mm

PDP – 40 x 40 mm



C



ecologic



Williams — 94669

Squeeze em vidro borossilicato com tampa em PP e uma pega em silicone. Capacidade até 470 ml. Food grade. Fornecida em caixa.

∅60 x 210 mm

SCR – 150 x 120 mm



112

Os Squeezes e copos ideais para manter a temperatura da sua bebida





Isolamento a vácuo em cobre



Tampa à prova de fugas



NEW

ecologic



Norre Bottle — 94662

Squeeze em aço inox com parede dupla isolada a vácuo, parede interna revestida de cobre e tampa em bambu com vedante de silicone para proteção extra. Tem capacidade até 640 ml e mantém as bebidas quentes por 16 h e frias por 48 h. Contém revestimento em pó que lhe confere mais durabilidade e resistência. Food grade. Fornecido em caixa presente de papel craft.



∅ 72 x 233 mm
LSR - 20 x 140 mm



Tampa com isolante em silicone



NEW

ecologic



Norre Tumbler — 94661

Copo em aço inox com parede dupla isolada a vácuo, parede interna revestida de cobre e tampa em bambu com vedante de silicone para proteção extra. Tem capacidade até 370 ml e mantém as bebidas quentes por 5 h e frias por 24 h. Contém revestimento em pó que lhe confere mais durabilidade e resistência. Food grade. Fornecido em caixa presente de papel craft.



∅ 80 x 106 mm
LSR - 30 x 55 mm

Um toque diferente

Para quem procura uma alternativa moderna e original aos tradicionais Squeezes, o acabamento em borracha irá surpreendê-lo.



A

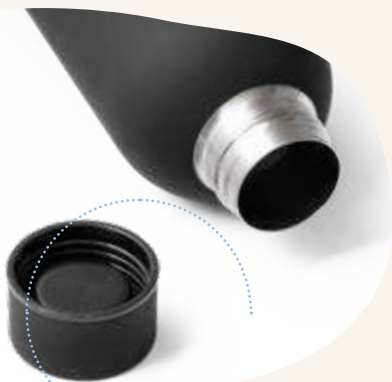

• Tampa à prova de fugas



NEW



Parede dupla isolada a vácuo



Odin — 94603

Squeeze em aço inox com acabamento em borracha, parede dupla isolada a vácuo e capacidade até 550 ml. Food grade. Fornecida em caixa de oferta.

∅ 70 x 220 mm
 SCR – 180 x 120 mm



550 ml



Parede dupla isolada a vácuo



Buffon — 94078

Squeeze em aço inox com parede dupla e tampa com sistema de vácuo. Capacidade até 530 ml. Food grade. Fornecida em caixa branca.

∅ 67 x 255 mm | Caixa: 75 x 75 x 275 mm
 SCR – 160 x 100 mm



+500 ml

Parede dupla isolada a vácuo

Responsável por eliminar a condensação e manter a temperatura da bebida. Para além disso, a parte exterior permanece à temperatura ambiente.



NEW



Show Satin — 94771

Squeeze em aço inox com parede dupla isolada a vácuo, capacidade até 540 ml e tampa à prova de fugas. Food grade. Fornecida em caixa de oferta branca.

∅71 x 255 mm

SCR – 140 x 80 mm

Parede dupla isolada a vácuo



Show — 94550

Squeeze em aço inox com parede dupla e tampa com sistema de vácuo. Capacidade até 510 ml. Food grade. Com caixa branca 94657.

∅67 x 255 mm

SCR – 140 x 80 mm

Tampa com isolante em silicone



Parede dupla isolada a vácuo



A



Parede dupla isolada a vácuo

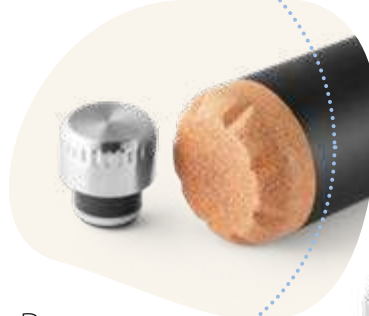

Base de cortiça

+550 ml



A

NEW



Solberg — 94240

Squeeze em aço inox e base em cortiça com parede dupla com isolamento a vácuo. Mantém as bebidas quentes por 8h e frias por 24h. Tem capacidade até 560 ml. Food grade. Fornecido em caixa.



∅ 66 x 258 mm
LSR - 25 x 100 mm



Parede dupla isolada a vácuo



Amorti — 94958

Squeeze para sublimação em aço inox com parede dupla e tampa com sistema de vácuo. Capacidade até 510 ml. Food grade. Fornecida em caixa branca 94657.

∅ 67 x 255 mm
SUB - 140 x 80 mm

360°

Ideal para impressão em sublimação



+500 ml



Leve o seu squeeze preferido para qualquer lado



Personalização a laser



Parede dupla isolada a vácuo



+550 ml

24H
8H



NEW

 **Ragnar** — 94602

 Squeeze em aço inox com parede dupla isolada a vácuo, tampa em bambu e alça de transporte em aço inox.

 Capacidade até 570 ml.

 Food grade. Fornecido em caixa presente de papel craft.

∅70 x 220 mm

LSR - ∅40 mm

Squeezes em alumínio



650 ml



Korver — 94631 + 94657 .358

Squeeze em alumínio e com tampa flip top em AS e alça para facilitar o transporte. Capacidade até 650 ml. Food grade. Caixa branca 94657 vendida opcionalmente.

∅66 x 250 mm

SCR - 200 x 130 mm



500 ml



119



119

114

105

128

137

127

106

147

103

A



Beane — 94063

+ 94657 .358

Squeeze em alumínio com tampa em aço inox e capacidade até 500 ml. Food grade. Caixa branca 94657 vendida opcionalmente.

∅67 x 205 mm

LSR - 25 x 80 mm



500 ml



127



106

360°

Ideal para impressão em sublimação



Billy II — 54957



Squeeze para sublimação em alumínio com tampa em aço inox. Capacidade até 500 ml. Caixa branca 94657 vendida opcionalmente.



∅67 x 205 mm



Inox SUB - 130 x 80 mm





Acabamento emborrachado

Acabamento matte com glitter



NEW

 **Queta soft** — 94256

 Squeeze em alumínio com acabamento emborrachado e tampa em bambu.
 Capacidade até 550 ml. Food grade. Caixa branca 94656 vendida opcionalmente.

∅65 x 197 mm
 / SCR - 135 x 110 mm

NEW

 **Queta** — 94250

 Squeeze de alumínio com acabamento matte e tampa em bambu. Capacidade até 550 ml. Food grade. Caixa branca 94656 vendida opcionalmente.

∅65 x 197 mm
 / SCR - 135 x 110 mm



105

800 ml



105

104

119

106

103



Sporty — 94633



94659



.358



Squeeze em alumínio com acabamento matt, tampa em PP e mosquetão. Capacidade até 800 ml. Food grade. Caixa branca 94659 vendida opcionalmente.



∅73 x 259 mm

SCR - 220 x 140 mm



114

750 ml



114

106

127

147



Siderot — 94688



94657



.358



Squeeze em alumínio com mosquetão e capacidade até 750 ml. Food grade. Caixa branca 94657 vendida opcionalmente.

∅73 x 247 mm

SCR - 220 x 140 mm

500 ml



127



106



Ideal para impressão em sublimação



Langford — 94960



94656



.358



Squeeze em alumínio para sublimação com mosquetão e capacidade até 500 ml. Food grade. Caixa branca 94656 vendida opcionalmente.

∅66 x 210 mm

SUB - 130 x 80 mm

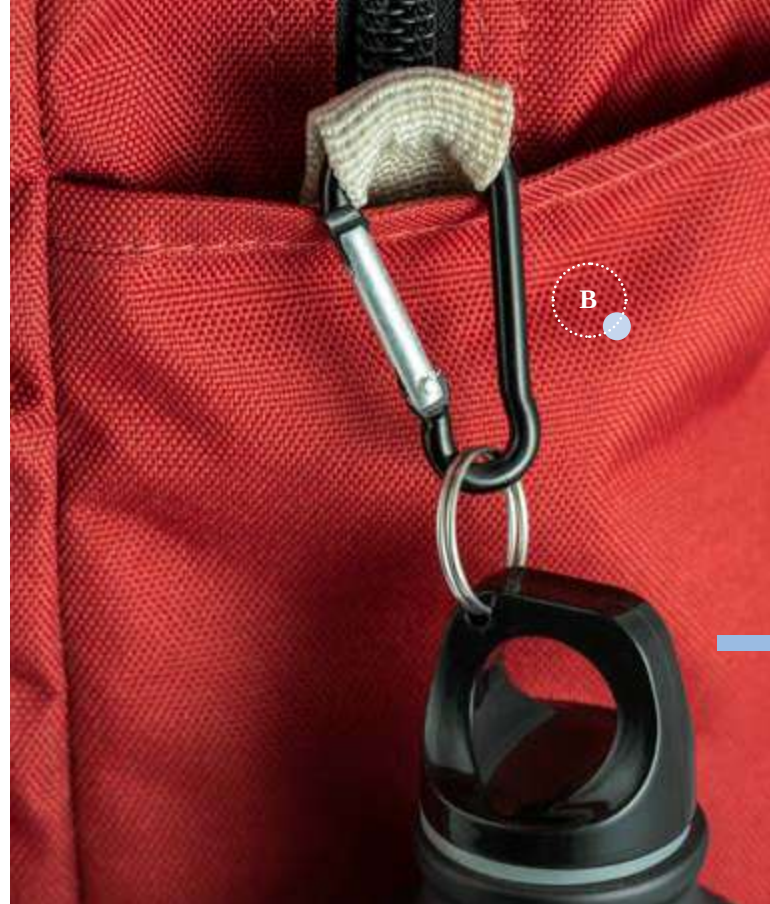

A



500 ml



 **Erald** — 94623 +  94656  .358

 Squeeze em alumínio com mosquetão e capacidade até 500 ml. Food grade. Caixa branca 94656 vendida opcionalmente.

∅66 x 210 mm

SCR - 200 x 110 mm

B







Acabamento mate

550 ml



NEW

 **Collina** — 94246 +  94650  .358

 Squeeze em alumínio com acabamento mate e mosquetão para facilitar o transporte. Capacidade até 550 ml. Food grade. Caixa branca 94650 vendida opcionalmente.

∅66 x 216 mm

SCR - 200 x 110 mm



+ 550 ml

+ 94656 .358



Kobe — 94060

Squeeze em alumínio com tira em silicone e capacidade até 570 ml. Food grade. Caixa branca 94656 vendida opcionalmente.

∅ 66 x 205 mm

LSR - 23 x 100 mm



• Canudo flexível no interior



+ 650 ml

+ 94652 .358



Lemon — 94649

Squeeze em alumínio com bico de canudo flexível em PP (no interior) e capacidade até 670 ml. Food grade. Caixa branca 94652 vendida opcionalmente.

∅ 73 x 217 mm

LSR - 25 x 120 mm



Slater — 94062 + 94654 .358

Squeeze em alumínio com formato triangular e tampa em PP. Capacidade até 570 ml. Food grade. Caixa branca 94654 vendida opcionalmente.

∅75 x 158 mm
 LSR – 40 x 100 mm



Rio — 94059 + 94651 .358

Squeeze em alumínio com tampa em PP e tira em silicone para facilitar o transporte. Capacidade até 660 ml. Food grade. Caixa branca 94651 vendida opcionalmente.

∅65 x 228 mm
 LSR – 25 x 150 mm

Garrafa com parede dupla isolada a vácuo e botão de abrir/fechar



500 ml



106



Ideal para sublimação



NEW

- Henderson** — 94264
- Garrafa em aço inox com parede dupla, para sublimação. Tampa com sistema de vácuo. Capacidade até 500ml. Mantém as bebidas quentes por 12h e frias por 24h.
- Food grade. Fornecida em caixa.

∅ 70 x 245 mm
SUB - 210 x 175 mm



500 ml



107



NEW

- Karpov** — 94610
- Garrafa em aço inox com parede dupla isolada a vácuo. Capacidade até 500 ml. Fornecida em caixa.
- Food grade.
- ∅ 69 x 240 mm
LSR - 25 x 150 mm



500 ml



105



104



106



103



NEW

- Luka** — 94615
- Garrafa em aço inox com parede dupla isolada a vácuo. Capacidade até 500 ml. Fornecida em caixa branca.
- Food grade.
- ∅ 70 x 245 mm
LSR - 25 x 150 mm





• Parede dupla isolada a vácuo

• Parede dupla isolada a vácuo



147

• Inclui 2 copos



107



750 ml

NEW



Heat — 94667



Garrafa em aço inox com parede dupla isolada a vácuo. Capacidade até 750 ml.



Inclui 2 copos. Food grade. Fornecida em caixa.

∅ 86 x 310 mm

LSR - 30 x 100 mm



1L

NEW



Liter — 94679



Garrafa em aço inox com parede dupla isolada a vácuo. Capacidade até 1L. Food grade. Fornecida em caixa.



Inclui 2 copos. Food grade. Fornecida em caixa.

∅ 82 x 330 mm

LSR - 30 x 150 mm

Squeeze com termômetro

Permite um maior controle
de temperatura da sua bebida,
deixando-a ao seu gosto.





• Parede dupla isolada a vácuo

106

127

103





happy

• Tampa com termómetro digital



NEW

Rossi — 94069

-  Squeeze em aço inox com parede dupla isolada a vácuo e tampa com termómetro digital.
-  Inclui infusor para chá. Mantém as bebidas quentes por 8 h e frias por 24 h e tem capacidade até 470 ml. Food grade. Fornecido em caixa.
-  Inox
-  \pm Ø65 x 229 mm
-  **SCR** - 130 x 80 mm



Copos de viagem com parede dupla isolada a ar



Ronde — 94677
 Copo de viagem em aço inox com corpo duplo e tampa deslizante. Capacidade até 400 ml. Food grade. Fornecida em caixa.
 Inox
 88 x 112 mm
 PDP – 30 x 30 mm



Hygge — 94678
 Copo de viagem com corpo duplo em aço inox e acabamento matt. Capacidade até 400 ml. Food grade. Fornecido em caixa.
 Inox
 Ø88 x 112 mm
 PDP – 30 x 30 mm

Revestimento em pó para
mais durabilidade

Parede dupla
isolada a vácuo



NEW

Phelps — 94772

Copo de viagem em aço inox e PP com parede dupla e isolamento a vácuo. Acabamento mate e revestimento em pó que lhe confere mais durabilidade e resistência. Tem capacidade até 470ml. Fornecido em caixa.

∅90 mm x 150 mm

LSR - 15 x 50 mm



106



104



133



**Ideal para impressão
em sublimação**

Parede dupla
isolada a vácuo



NEW

Slider — 94242

Copo de viagem para sublimação

com parede dupla em aço inox.

Inclui tampa transparente

com abertura deslizante.

Capacidade até 380ml.

Food grade. Fornecido em caixa.

∅77 x 120 mm

SUB - 246 x 120 mm



127



106



Abertura
deslizante



107



NEW



Himalayas — 94664

Conjunto de 4 copos em aço inox com bolsa para transporte em imitação de pele e com capacidade até 25 ml. Food grade. Fornecido em caixa de oferta.

∓ Ø44 x 62 mm

↗ LSR – 15 x 20 mm



103

A



Wings — 94614

Caneca em aço inox, com pega em forma e função de mosquetão. Capacidade até 230 ml. Food grade. Fornecida em caixa.

∓ Ø70 x 82 mm

↗ LSR – 15 x 70 mm



127



Noah — 94608

Caneca de viagem em aço inox e PP com tampa em PP. Capacidade até 420 ml. Food grade. Fornecida em caixa.

∓ Ø80 x 170 mm

↗ PDP – 35 x 30 mm



103



103



Werner — 94666

Copo de viagem em PP e PS com corpo duplo e capacidade até 520 ml. Tampa com sistema de abertura e fecho fácil. Corpo removível para personalização do interior. Food grade. Fornecido em caixa.

∓ Ø86 x 168 mm

↗ DGL – 220 x 136 mm



Tampa com sistema antiderrame



Monarda — 94681

Copo de viagem em aço inox com corpo duplo, tampa em PP com sistema anti derrame e antidesslizante na base. Capacidade até 470 ml. Food grade. Fornecido em caixa presente preta.

∅80 x 198 mm | Caixa: 82 x 202 x 82 mm

LSR – 30 x 100 mm



Batum — 94625

Copo de viagem em aço inox e PP com corpo duplo. Tampa com sistema de abertura e fecho fácil. Capacidade até 420 ml. Food grade. Fornecida em caixa.

∅81 x 187 mm

PDP – 25 x 50 mm

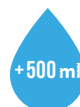

Hassi — 94676

Copo de viagem em aço inox e PP com corpo duplo e capacidade até 510 ml. Food grade. Fornecida em caixa presente branca.

∅87 x 151 mm

PDP – 25 x 50 mm



Copos de fibra de bambu



150

ECÓlogic



Toffa — 94066



Copo de viagem em fibra de bambu e PP com tampa flip top. Capacidade até 380 ml.



Food grade.



∅95 x 113 mm

PDP – 20 x 50 mm



150

ECÓlogic



Tisana — 94636



Copo para viagem em fibra de bambu e PP. Com tampa e capacidade até 450 ml.



Food grade.



∅93 x 134 mm

PDP – 20 x 50 mm



150

ECÓlogic



Valley — 94068



Copo de viagem em fibra de bambu (50%) e PP (50%) com canudo retrátil e capacidade até 450 ml. Pode ocorrer transferência de calor. Food grade.



∅93 x 135 mm

PDP – 20 x 40 mm



114



119

500 ml

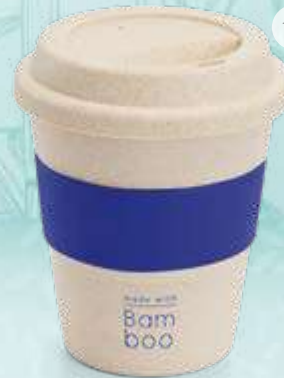

114



114

124

119

105

128

106

103

ECÓlogic



Canna — 94638



Copo de viagem em fibra de bambu (50%) e PP (50%), com tira de silicone no corpo para facilitar o transporte. A tampa em silicone no topo roda para tapar abertura e prevenir salpicos. Capacidade até 500 ml. Food grade.



∅95 x 140 mm



PDP – 20 x 20 mm



114

105

128

109

106

103

ECÓlogic



Latte — 94067



Copo de viagem em fibra de bambu (50%) e PP (50%) com tira em silicone para facilitar o transporte de bebidas quentes. Capacidade até 380 ml. Food grade.



∅95 x 114 mm



PDP – 25 x 25 mm



eco logic

Cuppa — 94058

Copo de viagem com tampa em fibra de bambu (50%) e PP (50%), com capacidade até 380 ml e tira em silicone para facilitar o transporte de bebidas quentes. Food grade.

∅ 95 x 114 mm
 PDP – 25 x 20 mm

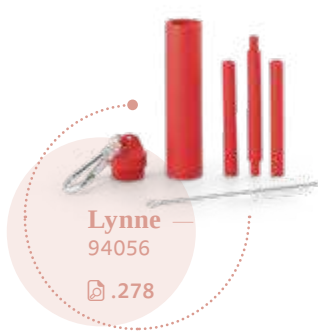

Lynne — 94056

.278



eco logic

Bacuri — 94691

Copo para viagem em fibra de bambu e PP. Com tampa e capacidade até 450 ml. Food grade.

∅ 93 x 134 mm
 PDP – 20 x 40 mm





Fibra de arroz

Resultante da transformação da casca de arroz após a colheita, a fibra de arroz permite a criação de produtos leves e resistentes, aproveitando esta matéria natural e biodegradável.



103



114



150

A



Fibra de bambu

ECologic



Cinnamon — 94626



Copo para viagem em fibra de bambu, casca de arroz e melamina. Com tampa e banda de silicone e capacidade até 450 ml. Food grade.



∅96 x 140 mm



PDP – 25 x 25 mm

B



Casca de arroz



ECologic

Petrelli — 94637



Copo em fibra de arroz (50%) e PP (50%) com acabamento matt. Capacidade até 400 ml. Food grade.



∅88 x 102 mm



PDP – 20 x 50 mm

Copos dobráveis

Práticos e fáceis de transportar, aliam a simplicidade à funcionalidade.



Orton — 94696

 Copo de viagem dobrável em silicone com tampa em PP. Contém uma argola na base que serve como pega ou para pendurar. Copo com capacidade até 240 ml. Food grade.

∓ Ø57 x 87 x 81 mm

↗ PDP - Ø35 mm



Modric — 94694

 Copo de viagem dobrável em silicone com tampa em PP. Contém uma argola na base que serve como pega ou para pendurar. Copo com capacidade até 240 ml. Food grade.

∓ Ø57 x 87 x 81 mm

↗ PDP - Ø35 mm



Orton L — 94697

 Copo de viagem dobrável em silicone com tampa em PP. Contém uma argola na base que serve como pega ou para pendurar. Copo com capacidade até 400 ml. Food grade.

∓ Ø66 x 117 x 96 mm

↗ PDP - Ø40 mm



Modric L — 94695

 Copo de viagem dobrável em silicone com tampa em PP. Contém uma argola na base que serve como pega ou para pendurar. Copo com capacidade até 400 ml. Food grade.

∓ Ø66 x 117 x 96 mm

↗ PDP - Ø40 mm

tritan™

Plástico super resistente, leve, cristalino e livre de BPA. Suporta altas temperaturas e não absorve cheiros.



tritan™



Pepe — 94620



Squeeze em Tritan™ com tampa flip top em PP, compartimento em ABS para cartões, chaves e dinheiro. Capacidade até 800 ml. Food grade. Fornecida em caixa.

∅ 80 x 260 mm

SCR – 70 x 70 mm



tritan™



Rozier — 94648

+ 94657 358



Squeeze em Tritan™ com capacidade até 790 ml. Food grade. Caixa branca 94657 vendida opcionalmente.

∅ 71 x 246 mm

SCR – 140 x 140 mm



tritan™



Dudley — 94628

+ 94657 358



Squeeze em tritan™ com tampa em PP, canudo flexível (no interior) e com sistema de abertura e fecho fácil. Contém suporte para celular e tem capacidade até 750 ml. Food grade. Caixa branca 94657 vendida opcionalmente.

∅ 75 x 222 mm

SCR – 230 x 120 mm

+750 ml

750 ml



Squeeze em rPET

Dão uma nova vida ao plástico que poderia ir parar aos oceanos ou demorar anos a deteriorar-se.

Pega em silicone



Senna — 94782



94651 .358



Squeeze produzido a partir de plástico reciclado, rPET. Com alça de silicone para facilitar o transporte. Tampa em PP e aço inox com isolante em silicone. Capacidade até 590 ml. Food grade. Caixa branca 94651 vendida opcionalmente.



∅66 x 230 mm



SCR – 120 x 100 mm

Bico "push-pull"

600 ml

104

106

104



 **Clouds** — 94632 +  94657  .358

 Squeeze em PS e tampa em ABS com bico "push-pull". Incluso vaporizador, alça para facilitar o transporte e capacidade até 600 ml. Food grade. Caixa branca 94657 vendida opcionalmente.

∅66 x 250 mm

SCR – 200 x 120 mm

+700 ml

106

114



+700 ml

110

Infusor para fruta no interior



 **Othmer** — 94644 +  94658  .358

 Squeeze em AS com tampa em PE, porta comprimidos em PP, com 7 divisórias e capacidade até 740 ml.

 Food grade. Caixa branca 94658 vendida opcionalmente.

∅75 x 240 mm

SCR – 20 x 60 mm

 **Town** — 94629 +  94657  .358

 Squeeze em AS e com tampa flip top em PP com infusor de frutas e capacidade até 740 ml. Food grade. Caixa branca 94657 vendida opcionalmente.

∅70 x 247 mm

SCR – 210 x 130 mm



Base e tampa em aço inox

A



Ancer — 94687 + 94670 .358
 Squeeze em AS e aço inox com capacidade até 700 ml. Food grade. Caixa branca 94670 vendida opcionalmente.
 Ø74 x 265 mm
 SCR - 220 x 80 mm

600 ml



Serena — 94618 + 94650 .358
 Squeeze em AS com tampa em aço inox e capacidade até 600 ml. Food grade. Caixa branca 94650 vendida opcionalmente.
 Ø71 x 215 mm
 PDP - 20 x 50 mm

Torne seus Squeezes e marmitas em presentes inesquecíveis!

Personalize seus Squeezes e marmitas e coloque seu logo numa caixa presente! Disponíveis em 12 tamanhos distintos, para valorizar sua marca!



Horus 1 — 94650

Caixa em cartão, indicada para as referências: 94618 e 94246.

☒ 75 x 75 x 225 mm

🔪 SCR – 50 x 170 mm

Horus 2 — 94651

Caixa. Cartão. Indicada para as referências 94059; 94061; 94621; 94646 e 94782.

☒ 75 x 75 x 235 mm

🔪 SCR – 50 x 170 mm

Horus 3 — 94652

Caixa. Cartão. Indicada para as referências 94622 e 94649.

☒ 80 x 95 x 220 mm

🔪 SCR – 50 x 170 mm

Horus 4 — 94653

Caixa em cartão, indicada para as referências: 99967 e 54641.

☒ 75 x 75 x 190 mm

🔪 SCR – 50 x 165 mm

Horus 5 — 94654

Caixa. Cartão. Indicada para as referências 94062 e 94619.

☒ 95 x 95 x 170 mm

🔪 SCR – 70 x 145 mm

Horus 6 — 94655

Caixa em cartão, indicada para a referência: 94646.

☒ 82 x 82 x 233 mm

🔪 SCR – 60 x 180 mm

Titus 1 — 94656

Caixa. Cartão. Indicada para as referências 94060; 94250; 94256; 94623; 94686 e 94960.

☒ 70 x 70 x 215 mm

🔪 SCR – 45 x 170 mm

Titus 2 — 94657

Caixa. Cartão. Indicada para as referências 54957; 94063; 94550; 94628; 94629; 94630; 94631; 94632; 94648; 94688 e 94958.

☒ 77 x 77 x 257 mm

🔪 SCR – 55 x 180 mm

Titus 3 — 94658

Caixa. Cartão. Indicada para a referência 94644.

☒ 82 x 82 x 265 mm

🔪 SCR – 60 x 180 mm

Titus 4 — 94659

Caixa. Cartão. Indicada para a referência 94633.

☒ 115 x 115 x 195 mm

🔪 SCR – 85 x 160 mm

Titus 5 — 94670

Caixa. Cartão. Indicada para a referência 94687.

☒ 80 x 80 x 275 mm

🔪 SCR – 55 x 220 mm

Otao — 93852

Caixa em cartão, indicada para a referência: 93853.

☒ 190 x 105 x 108 mm

🔪 SCR – 165 x 80 mm



+ 94657 .358



Portis — 94630

Squeeze em PP e com tampa em PS e capacidade até 600 ml. Food grade. Caixa branca 94657 vendida opcionalmente.

∅67 x 245 mm

SCR – 200 x 120 mm



600 ml



+ 94652 .358



Odret — 94622

Squeeze em AS com tampa em PP com boquilha de canudo flexível (no interior) e de abertura fácil. Capacidade até 650 ml. Food grade. Caixa branca 94652 vendida opcionalmente.

∅73 x 214 mm

SCR – 190 x 55 mm



650 ml

Canudo flexível no interior

Canudo flexível no interior



+ 94651 .358



Conley — 94621

Squeeze em PS com tampa em PE com bico de canudo flexível (no interior) e de abertura fácil. Capacidade até 500 ml. Food grade. Caixa branca 94651 vendida opcionalmente.

∅70 x 230 mm

SCR – 190 x 120 mm



500 ml



+ 94651 .358



Jay — 94061

Squeeze em AS com tampa em PP. Canudo incluso e capacidade até 610 ml. Food grade. Caixa branca 94651 vendida opcionalmente.

∅70 x 225 mm

SCR – 220 x 120 mm



+ 600 ml



+500 ml



Launay — 94686

+ 94656 .358

Squeeze em AS com tampa em PP e capacidade até 510 ml. Food grade. Caixa branca 94656 vendida opcionalmente.

∅68 x 203 mm

SCR – 200 x 80 mm



Bocuse — 93853

.281



Turmeric — 53878

.283

550 ml



109



106

Com escala de medição



109



106



103



114



105



Nurmi — 94619

+ 94654 .358

Shaker em HDPE com tampa flip top em PP. Incluso misturadora em aço inox e escala de medição até 400 ml. Capacidade até 550 ml. Food grade. Caixa branca 94654 vendida opcionalmente.

∅93 x 160 mm

PDP – 25 x 50 mm

Squeezes dobráveis com mosquetão

com um design flexível e prático que podem acompanhá-lo para qualquer lado.



Kwill — 94612

Squeeze dobrável em PE com bico de sistema “push-pull” e acabamento translúcido. Contém uma tampa transparente e um mosquetão. Capacidade até 460 ml. Food grade.

☒ 120 x 265 x 30 mm

🔪 **SCR** – 70 x 80 mm



Decnop — 94689

Squeeze dobrável em PE com capacidade até 460 ml e acabamento matt. Food grade.

☒ 110 x 218 x 64 mm

🔪 **SCR** – 60 x 70 mm

Cores metálicas



Gilded — 94690

Squeeze dobrável com mosquetão e tampa, com capacidade até 460 ml, disponível em cores metalizadas. Food grade.

☒ 110 x 218 x 64 mm

🔪 **SCR** – 70 x 60 mm

Toalhas de esporte

O aliado para se esfriar durante a atividade física.

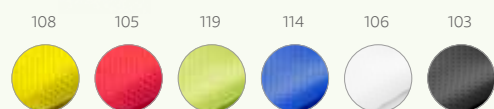

NEW
rPET **ECÓlogic**

Bernal — 99969

Toalha esportiva refrescante em rPET. Fornecida numa bolsa preta em non-woven. Toalha reutilizável, lavável na máquina de lavar roupa.

300 x 800 mm | Bolsa: 100 x 200 mm

TRS – 200 x 200 mm

Quando molhada, permanece fria durante horas



Artx Plus — 99967

Kit toalha e garrafa. Toalha para esporte em poliamida e poliéster. Toalha refrescante, quando molhada permanece fria durante horas. Se aquecer, basta balançar reativando sua frescura. Reutilizável e lavável à máquina. Garrafa em PP e PET com mosquetão incluso (food grade). Capacidade até 440 ml. Caixa branca 94653 vendida opcionalmente.

300 x 800 mm | Garrafa: Ø65 x 183 mm

TRS – 100 x 60 mm



NEW

Artx — 99968

Toalha esportiva em poliamida e poliéster. Toalha refrescante, quando molhada permanece fria durante algumas horas. Se aquecer, basta abanar, reativando a sua frescura. Toalha reutilizável, lavável na máquina de lavar roupa.

300 x 800 mm

TRS – 200 x 150 mm

Elevada absorção e secagem rápida



Matira — 99965

Toalha para esporte em microfibras (210 g/m²). Toalha prática e leve que facilita o transporte, de elevada absorção e rápida secagem. Fornecida com bolsa em 190T.

300 x 300 mm | Bolsa: 110 x 140 mm

TRS – 60 x 50 mm

Travis — 99966

Toalha para esporte em microfibras (210 g/m²). Toalha prática e leve que facilita o transporte, de elevada absorção e rápida secagem. Fornecida com bolsa em 190T.

400 x 800 mm | Bolsa: 135 x 205 mm

TRS – 80 x 80 mm

Seja visto a qualquer distância

- Colete refletivo para crianças



NEW

Mike — 98501

Colete refletivo para criança em poliéster (100%). Contém 2 bandas retrorrefletivas horizontais, fecho com velcro lateral e é certificado pela norma EN 17353. Produto não destinado para uso profissional.

☒ Tamanho único: 370 x 470 mm

🔪 TRS – 230 x 60 mm



NEW

Roger — 98504

Bolsa em 100% poliéster com fecho de velcro. Indicada para guardar o colete 98503.

☒ 145 x 220 mm

🔪 TRS – 70 x 150 mm



NEW

Thiem — 98502

Colete de alta visibilidade em 100% poliéster com certificado pela norma EN 17353. Colete refletivo com 2 bandas refletoras horizontais e elásticos laterais. Este produto não é adequado para uso profissional.

☒ 540 x 620 mm

🔪 TRS – 100 x 90 mm



NEW

Yellowstone — 98503

Colete de alta visibilidade em 100% poliéster com certificado pela norma EN ISO 20471 classe 2. Colete refletivo com 2 bandas refletoras horizontais e abertura frontal com fecho de velcro.

☒ Tamanho único: 670 x 700 mm

🔪 TRS – 140 x 100 mm



Rules — 92835

Sacola tipo mochila em 210D, com elementos refletivos. Produto promocional.

☒ 350 x 400 mm

🔪 TXP – 250 x 160 mm



Elementos
refletores



Confor — 97207

Braçadeira para celular em soft shell de alta densidade, com elementos refletivos e fechamento ajustável. Para smartphone 6.5".

440 x 175 mm

SCR — 25 x 40 mm



Spirited — 97205

Braçadeira para celular em soft shell com banda refletiva e fechamento ajustável. Para smartphone 5.1".

450 x 165 mm

SCR — 38 x 45 mm



Mounti —
92628

.194



Wilkins —

97341

.79

Bolso ideal
para pequenos
objetos



Yates — 92799

Bolsa para bicicleta em 600D, com 3 fitas ajustáveis.

230 x 200 x 60 mm

TRS — 90 x 45 mm

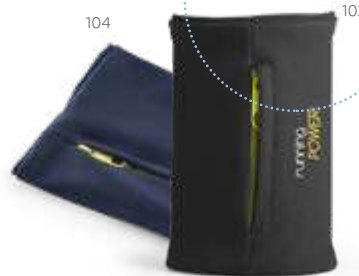

Picchu — 99023

Punho elástico em poliéster com bolso com zíper, ideal para guardar bens de pequeno tamanho e usar durante a prática esportiva.

100 x 100 mm

TRS — 50 x 50 mm



Kov — 99022

Punho elástico em poliéster com área apropriada para personalização, disponível em várias cores.

75 x 78 mm

TRS — Ø20 mm



Jogue seu esporte favorito equipado com os melhores acessórios



4 níveis de resistência

Muito leve



Leve



Média



Forte



NEW

A

Burpee — 99970

Conjunto de 4 bandas elásticas de ginástica em bolsa de non-woven preta. Cada banda tem um nível de resistência diferente: Vermelha - forte; Amarela - média; Azul - leve; Verde - muito leve

📏 Bolsa: 100 x 200 mm

🔪 TRS - 80 x 140 mm



Zippers Sport — 92516

📏 .180



Fit — 92511

📏 .195



B



Brady — 98086

Kit fitness composto por elástico e corda de pular. Fornecido com bolsa em 190T.

📏 Bolsa: 210 x 270 mm

🔪 TRS - 150 x 150 mm



Escolha o melhor utensílio para o acompanhar em suas atividades e esteja preparado para resolver qualquer imprevisto



• Com **4** leds e **5** pontas diferentes

123

Gabro — 94017

LED

Conjunto de ferramentas em ABS com clipe, 4 LEDs e 5 pontas diferentes removíveis. Incluso 2 pilhas AAA.

∓ 90 x 30 x 35 mm

↗ PDP – 25 x 10 mm



114



114

147



Basalt — 94020

Conjunto de mini chave de parafusos em metal com 3 pontas diferentes removíveis com opção de guardar as peças no topo do corpo com tampa. Chaveiro incluído.

∓ Ø13 x 75 mm

↗ LSR – 30 x 6 mm



A



103



104



106



105

A

Chert — 94018

Conjunto de mini chave de parafusos em PS com 4 pontas diferentes removíveis com opção de guardar as peças no corpo.

∓ 92 x 22 x 13 mm

↗ SCR – 55 x 10 mm

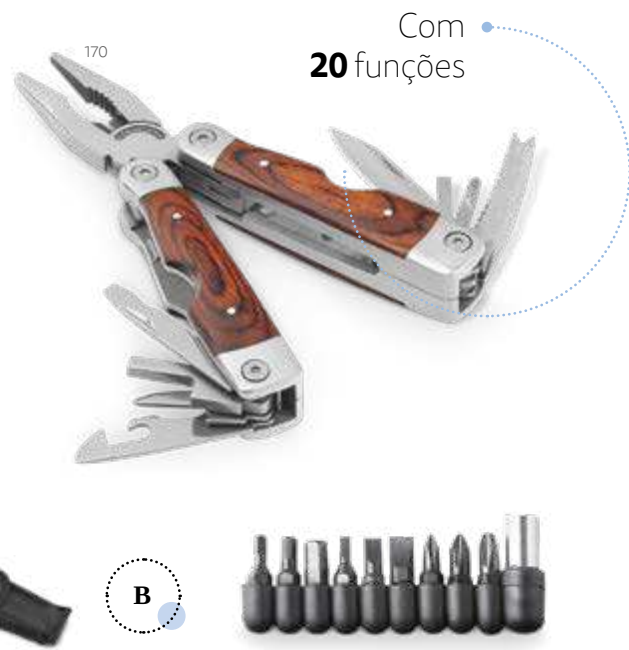

NEW
Inox Dunito — 94016
 Mini alicate multifunções dobrável em aço inox e alumínio com 9 funções. Fornecido em bolsa de 600D.
 📏 Fechado: 35 x 70 x 18 mm | Bolsa: 50 x 90 x 20 mm
 🔪 LSR – 25 x 4 mm

NEW
Inox Magnum — 94022
 Alicate dobrável com ferramentas multifunções em aço inox e madeira, com 20 funções. Fornecido em bolsa em poliéster.
 📏 45 x 100 x 25 mm | Bolsa: 65 x 140 x 30 mm
 🔪 PDP – 30 x 25 mm

Com **20** funções

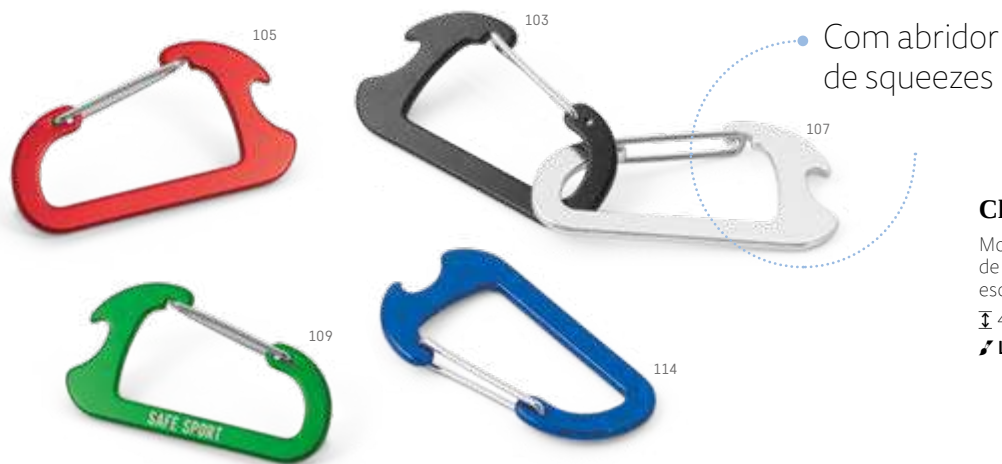

Close — 98824

Mosquetão em alumínio com abridor de garrafas. Não adequado para escalada esportiva.

▮ 44 x 79 x 3 mm

↙ LSR - 50 x 5 mm



Bresset — 98823

Mosquetão em alumínio com área plana para gravação.

▮ 32 x 57 x 5 mm

↙ LSR - 30 x 3 mm



Limardo — 98822

Mosquetão em alumínio com área plana para gravação.

▮ 24 x 48 x 4 mm

↙ LSR - 25 x 3 mm



Criança
& Escolar



A



**Valorize
a imaginação
das crianças
e torne
os momentos
de brincadeira
mais divertidos**



EcoLogic

Croco — 51746

Caixa de cartão
com 12 lápis de cor.

▮ 90 x 180 x 9 mm

✂ SCR – 60 x 90 mm



EcoLogic

Crafti — 51931

Caixa de cartão
com 10 mini lápis de cor.

▮ 40 x 90 x 15 mm

✂ SCR – 25 x 50 mm



EcoLogic

Bird — 51750

Caixa de cartão
com 6 mini lápis de cor.

▮ 45 x 90 x 9 mm

✂ SCR – 35 x 50 mm



EcoLogic

Coloured — 51747

Caixa de cartão
com 12 lápis de cor.

▮ 90 x 90 x 9 mm

✂ SCR – 45 x 60 mm



160

8 desenhos
para colorir



Jaguar — 51755

Kit para pintar em caixa de cartão. Incluso 8 giz de cera e 8 cartões diferentes para pintar e pendurar.

▮ 180 x 90 x 10 mm

✂ SCR - 55 x 60 mm



160

Eagle — 51754

Caixa de cartão com 6 giz de cera.

▮ 53 x 92 x 9 mm

✂ SCR - 40 x 50 mm



160

Anim — 51758

Kit para pintar em caixa de cartão. Incluso 6 mini lápis de cor, 1 apontador e 15 cartões diferentes para pintar.

▮ 73 x 89 x 12 mm

✂ SCR - 50 x 55 mm



105

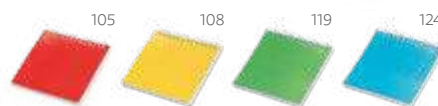

105

108

119

124

Cuckoo — 93466

Caderno para colorir com 25 desenhos diferentes. Capa disponível em várias cores. Lápis não inclusos.

▮ 90 x 90 mm

✂ SCR - 70 x 60 mm

Preparados para aprender!

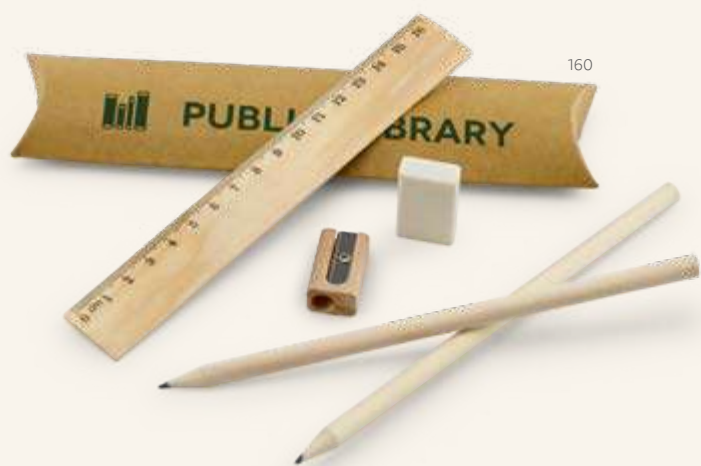

Rhombus — 51932

Kit de escrita composto por régua de 16,5 cm, 2 lápis de grafite, 1 borracha e 1 apontador. Fornecido com bolsa em cartão.

☞ Bolsa: 190 x 45 x 20 mm

☞ SCR – 170 x 30 mm



Poodle — 51756

Conjunto de desenho fornecido em caixa de madeira. Incluso uma régua de 20 cm, seis lápis de cor, um lápis de grafite, um apontador e uma borracha.

☞ 220 x 43 x 32 mm

☞ LSR – 190 x 20 mm



Rols — 51751

Caixa cilíndrica em cartão com 6 mini lápis de cor. Incluso apontador.

☞ Ø26 x 106 mm

☞ PDP – 10 x 45 mm



Cricket — 51752

Caixa cilíndrica em cartão com 12 lápis de cor para pintar.

☞ Ø35 x 97 mm

☞ PDP – 10 x 45 mm



Ateneo — 51736

Lápis com borracha.
Grau de dureza: HB.

∓ Ø7 x 190 mm

↙ PDP - 40 x 5 mm



Beetle — 51904

Lápis apontado
com boneco de borracha.
Grau de dureza: HB.

∓ Ø7 x 188 mm

↙ PDP - 40 x 5 mm



Rizzoli — 51738

Lápis apontado. Grau de dureza: HB.

∓ Ø8 x 175 mm

↙ PDP - 40 x 5 mm



Aguza — 53621

Apontador 2 em 1 em PS com depósito transparente e borracha com tampa.
Disponível em várias cores.

∓ 41 x 60 x 23 mm

➤ PDP - 20 x 10 mm



Yglo — 93620

Apontador em PS com depósito.
Disponível em várias cores.

∓ 41 x 40 x 30 mm

➤ PDP - 15 x 6 mm



Ernster
51721

∓ .156



Barter —
51759

∓ .156

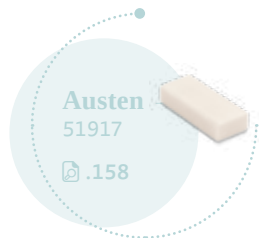

Austen
51917

∓ .158



Cornwell
51716

∓ .156

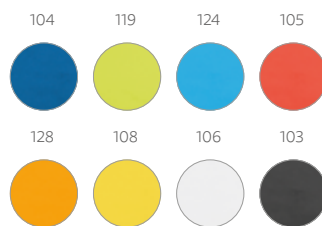

Siza — 51935

Borracha em TPR com capa protetora em PP.

∓ 55 x 33 x 13 mm

➤ PDP - 20 x 15 mm



104



119



128



119

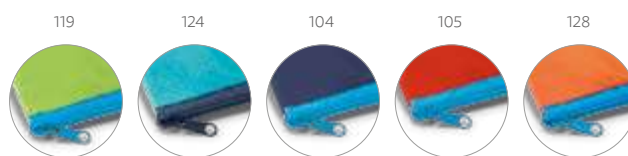

Hummingbird — 93614

Estojo para lápis em 600D.

∓ 210 x 85 x 65 mm

✂ TRS – 130 x 60 mm

Colorit — 93619

Estojo para lápis em non-woven (100 g/m²).

∓ 210 x 110 mm

✂ TRS – 150 x 60 mm



106

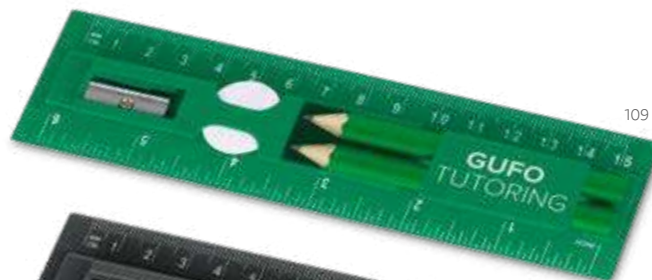

109



105

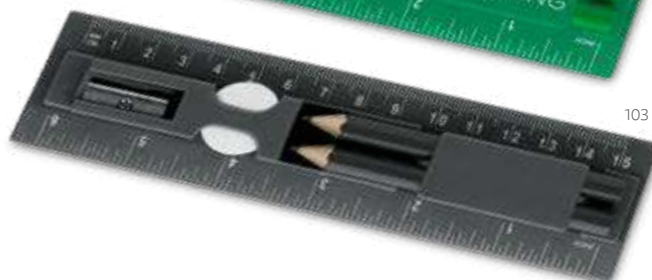

103

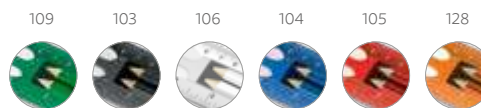
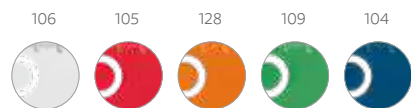

Stephenie — 53565

Régua com escala de 15 cm impressa, cantos redondos e com clipe.

∓ 174 x 31 x 2 mm

✂ SCR – 55 x 8 mm

Gufo — 93566

Kit de escrita em PS. Incluso régua de 15 cm, 2 mini lápis, 1 borracha e 1 apontador.

∓ Régua: 157 x 42 x 15 mm

✂ PDP – 30 x 15 mm



Estojo em algodão

ecologic

Schooli — 93607

Estojo para lápis em algodão.

∅ 70 x 220 mm

TR5 - 130 x 60 mm



Estimular a criatividade

Pintar é uma das brincadeiras mais completas, pois ajuda a estimular e a desenvolver a criatividade.



3 desenhos para colorir



Giraffe — 54635

Copo para viagem para crianças em PP e PS com canudo flexível e capacidade até 200 ml. Corpo com 3 desenhos diferentes para colorir (6 mini lápis em cor inclusos). Food grade.

∅ 72 x 98 mm

PDP – 25 x 30 mm



Baloo — 52619

Sacola tipo mochila para colorir em non-woven (80 g/m²) com desenho impresso e bolso interior. 6 gizos de cera inclusos.

300 x 350 mm

TRS – 200 x 60 mm



Gusteau — 59834

Avental de criança para colorir em non-woven (80 g/m²) com desenho impresso e bolso lateral. 6 gizos de cera inclusos.

380 x 430 mm

TRS – 120 x 120 mm



Lavender — 99826

Avental para criança em non-woven (80 g/m²) com bolso e alças ajustáveis.

▮ 400 x 600 mm |

Bolso: 200 x 150 mm

✂ TRS - 150 x 100 mm



Bissaya — 92617

Sacola tipo mochila em non-woven (80 m/g²) com cantos triangulares coloridos.

▮ 300 x 350 mm

✂ TXP - 160 x 160 mm



Colete refletivo para crianças



NEW

Mike — 98501

Colete refletivo para criança em poliéster (100%). Contém 2 bandas retrorrefletivas horizontais, fecho com velcro lateral e é certificado pela norma EN 17353. Produto não destinado para uso profissional.

▮ Tamanho único: 370 x 470 mm

✂ TRS - 230 x 60 mm



Berna — 92667

Mochila em 600D com bolso frontal com fecho. Parte posterior e alças almofadadas.

▮ 310 x 410 x 120 mm

▮ TRS - 130 x 80 mm

Rocket — 92614

Mochila em 600D com bolso frontal com zíper e 2 bolsos laterais em tela.

▮ 240 x 320 x 80 mm

▮ TRS - 140 x 90 mm



Benny — 92615

Mochila em 600D com bolso frontal e bolsos laterais com zíper.

▮ 240 x 320 x 120 mm

▮ TRS - 130 x 100 mm





B



C



105



124

105

B



105



106



124



Turtle — 58412

Bolsa térmica em 600D com bolso interior em rede e alça ajustável em webbing. Com capacidade até 4,5 L, tem o tamanho ideal para levar refeições para o trabalho ou escola. Food grade

▮ 200 x 200 x 110 mm

▮ TRS - 160 x 160 mm

C



Sebastian — 98416

Bolsa térmica para criança em 600D com bolso frontal, fechamento em zíper e bolso lateral em rede. Contém alça ajustável em webbing e tem capacidade até 3 L. Food grade

▮ 190 x 230 x 80 mm

▮ TRS - 150 x 90 mm

Guarda-chuvas infantis



Bambi — 99133

Guarda-chuva para criança em poliéster e pega em EVA.

∅ 680 x 550 mm
TXP – 150 x 90 mm



105

123

124

Stork — 99123

Guarda-chuva para criança em poliéster 190T.

∅ 870 mm | 660 mm
TXP – 150 x 120 mm



Nicholas
99143

∞ .393



Sol & Chuva





Varetas de fibra de vidro

Guarda-chuva grande de portaria

103



Aproximadamente **1,4 m** de diâmetro

103

106

104



NEW



Eiger — 99042



Guarda-chuva grande de portaria em 190T pongee. Varetas e haste em fibra de vidro e pega em madeira.

∅ 1375 x 855 mm

TR5 - 200 x 120 mm



A



Uma afirmação de sustentabilidade!

Design diferenciador, útil mas sobretudo amigo do meio ambiente. Prepare-se para o inverno com opções mais responsáveis.

Abertura automática



160



A

ECologic

 **Sobral** — 99141

 Guarda-chuva em cortiça com haste e pega em madeira. Abertura automática.

∅1050 mm | 890 mm

TR5 – 200 x 120 mm



129

104

106

103



129



NEW

ecologic



Apolo — 99149



Guarda-chuva em rPET pongee com abertura automática, haste e estrutura em metal. Pega em madeira.

∅1050 x 850 mm

TR5 – 200 x 120 mm

104

Guarda-chuva reversível

Modelo patenteado com uma tecnologia de desempenho excepcional, pensada para evitar molhar-se sempre que fecha o guarda-chuva.



Angela — 99146

Guarda-chuva reversível em pongee 190T com capa dupla, cabo em metal e varetas em fibra de vidro. O guarda-chuva de estrutura patenteada tem abertura manual e fecho automático.

∅1050 mm | 790 mm

TR5 – 200 x 120 mm



103



Abertura automática



Guil — 99126

Guarda-chuva de 12 varetas em poliéster 190T e pega revestida a borracha com mecanismo de abertura automática.

∅1100 mm | 900 mm

TXP – 120 x 120 mm

105



Abertura automática

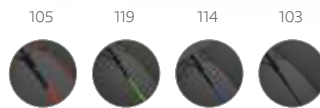

Alberta — 99145

Guarda-chuva em pongee 190T com varetas em fibra de vidro coloridas e pega revestida a borracha. Abertura automática.

∅1040 mm | 870 mm

TXP – 220 x 140 mm



Prepare-se para o inverno

Os guarda-chuvas com tecido pongee são mais resistentes à água, secam mais depressa e são recicláveis. Para além disso a abertura automática e as varetas em fibra de vidro conferem-lhes maior segurança e utilidade.

104

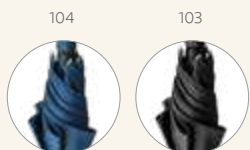

104

103



NEW

Sessil — 99155



Guarda-chuva em 190T pongee, varetas em fibra de vidro, cabo em alumínio e haste revestida em borracha. Guarda-chuva à prova de vento com abertura automática. Fornecido em bolsa com alça curta para facilitar transporte.

☒ Guarda-chuva: Ø1025 x 855 mm | Bolsa: 90 x 635 mm

🔪 TRS – 200 x 120 mm



Varetas de fibra de vidro

Pega revestida em borracha

113



113

104



Silvan Stripe — 99153



Guarda-chuva em 190T pongee com varetas em fibra de vidro e pega em c. sintético. Guarda-chuva à prova de vento com abertura automática.

☒ Ø1175 x 925 mm

🔪 TXP – 200 x 150 mm

129

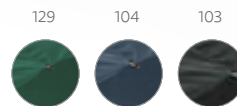

129

104

103



Felipe — 99130



Guarda-chuva de golfe em pongee 190T com haste e varetas em fibra de vidro e pega em PP. O guarda-chuva é à prova de vento e tem abertura automática. Fornecido em bolsa.

☒ Ø1170 mm | 880 mm | Bolsa: 85 x 725 mm

🔪 TXP – 220 x 140 mm



Efeito refletor

Em dias de chuva cinzentos, opte por guarda-chuvas com efeito refletor para uma maior segurança.



Abertura automática e pega revestida a borracha



Abertura automática e pega em alumínio



Megan — 99152
Guarda-chuva em poliéster com faixa refletora. Pega revestida a borracha e abertura automática.
∅960 x 815 mm
TRS – 200 x 120 mm

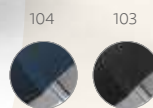

Karen — 99115
Guarda-chuva em poliéster 190T. Haste e pega em alumínio com mecanismo de abertura automática.
∅1050 mm | 890 mm
TXP – 220 x 140 mm

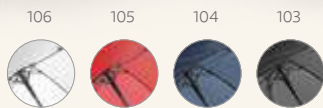

Stuart — 99142
Guarda-chuva grande de portaria em 190T pongee com abertura automática. Varetas e haste em fibra de vidro e pega em madeira.
∅1040 mm | 830 mm
TXP – 220 x 140 mm

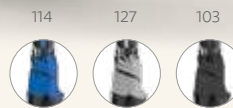

Jenna — 99137
Guarda-chuva em poliéster 190T com pega em EVA e abertura automática. Detalhe com linha colorida no guarda-chuva e na pega.
∅1040 mm | 825 mm
TXP – 220 x 140 mm



Varetas de fibra de vidro



NEW



Reno — 99043

Guarda-chuva em 190T pongee com abertura automática. Varetas em fibra de vidro e pega e haste em madeira.

∅1040 x 885 mm

TR5 — 200 x 120 mm



104



104



111



105



113



108



106



129



103



Para dias de chuva ou de sol

O golf é um desporto que se pratica tanto em dias de chuva como em dias de sol, por isso ter um bom guarda-chuva ajudará a obter a concentração necessária.



103

Karl — 99122

Guarda-chuva de golfe em poliéster 190T com pega em EVA.

∅1220 mm | 975 mm

TXP — 220 x 140 mm



105

105



104



106



103



Roberto — 99109

Guarda-chuva de golfe em poliéster 190T e pega em madeira. Abertura manual.

∅1270 mm | 965 mm

TXP — 220 x 140 mm



LIVE A
 Colourful
 LIFE



 **Patti** — 99116
 Guarda-chuva em poliéster
 190T com haste em metal
 e pega em madeira
 e abertura automática.
 Ø1040 mm | 885 mm
 TXP – 220 x 140 mm





119

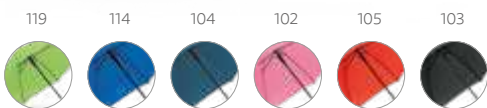

Michael — 99134

Guarda-chuva em poliéster 190T com pega revestida a borracha e abertura automática.

∅1040 mm | 830 mm

TXP – 220 x 140 mm



100

16 varetas

190T pongee



Duha — 99140

Guarda-chuva arco-íris em 190T pongee com 16 varetas e pega em madeira.

∅1020 x 875 mm

TRS – 120 x 120 mm



106

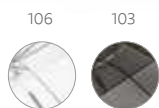

Nicholas — 99143

Guarda-chuva transparente em POE com abertura automática.

∅1000 mm | 815 mm

PDP – 50 x 7 mm



113

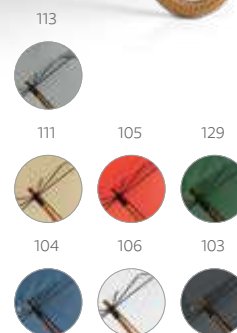

Betsey — 99100

Guarda-chuva em poliéster 190T com haste e pega em madeira. Abertura manual.

∅1040 mm | 885 mm

TXP – 220 x 140 mm

Compactos e práticos

Perfeitos para levar sempre consigo.

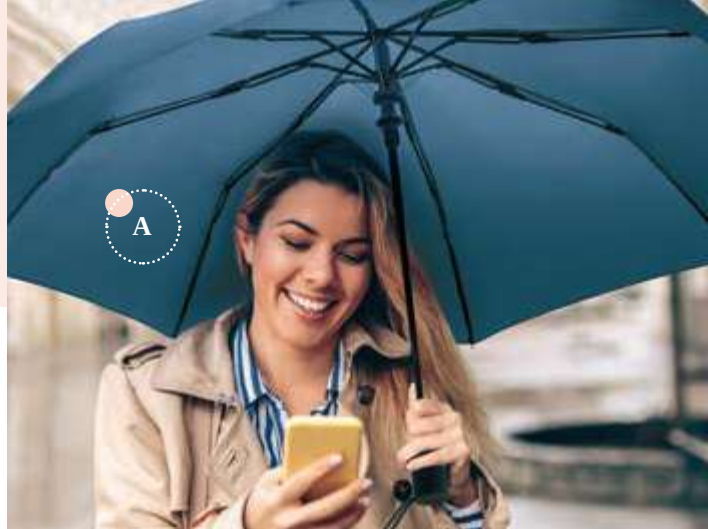

104

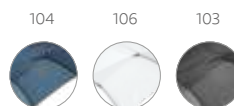

Tomas — 99139

Guarda-chuva dobrável em poliéster 190T dobrável em 3 secções com abertura automática. Fornecido em bolsa.

∅ 980 mm | 295 mm | Bolsa: Ø45 x 245 mm

TXP – 200 x 120 mm



129



108

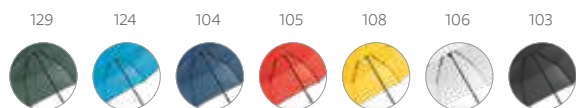

Maria — 99138

Guarda-chuva em poliéster 190T dobrável em 3 secções e de abertura manual. Guarda-chuva prático e leve fornecido em bolsa.

∅ 960 mm | 240 mm | Bolsa: Ø40 x 215 mm

TRS – 200 x 120 mm

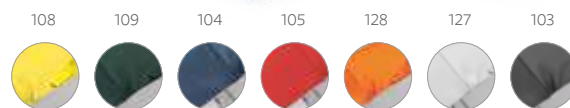

Tigot — 99135

Guarda-chuva em poliéster 190T dobrável em 3 secções e de abertura manual. Disponível em várias cores, com interior em cinza. Guarda-chuva prático e leve fornecido em bolsa.

∅ 960 mm | 240 mm | Bolsa: Ø40 x 225 mm

TXP – 200 x 120 mm

• Pega revestida em borracha



104

103



• Abertura automática



Campanela — 99151

Guarda-chuva dobrável em 190T pongee. Pega revestida em borracha e abertura automática. Fornecido em bolsa.

☒ Ø980 mm | 320 mm | Bolsa: Ø50 x 240 mm

☞ TXP – 200 x 100 mm



104

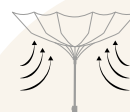

• À prova de vento



103

• Abertura e fecho automático

• Com lanterna na pega

Muriel — 39000

Guarda-chuva em poliéster dobrável em 3 seções com lanterna na pega (incluso 2 pilhas CR2032). Fornecido em bolsa.

☒ Ø940 mm | 310 mm | Bolsa: Ø50 x 230 mm

☞ TXP – 200 x 120 mm



Stella — 99147

Guarda-chuva em Pongee 190T dobrável em 3 seções e com abertura automática. Pega revestida a borracha. Guarda-chuva à prova de vento. Fornecido em bolsa.

☒ Ø970 mm | 280 mm | Bolsa: Ø50 x 250 mm

☞ TXP – 200 x 120 mm

Guarda-chuvas infantis



105



100

105

123

124



A

Stork — 99123

Guarda-chuva para criança em poliéster 190T.

∅ 870 mm | 660 mm

TXP - 150 x 120 mm



Bambi — 99133

Guarda-chuva para criança em poliéster e pega em EVA.

∅ 680 x 550 mm

TXP - 150 x 90 mm





Mais proteção contra a chuva

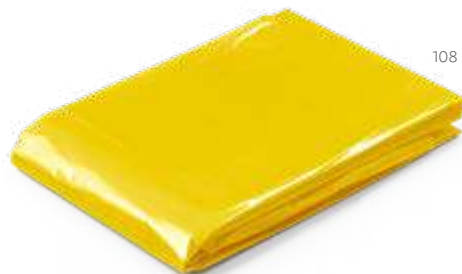

Sandra — 99213

Capa de chuva de tamanho único, disponível em várias cores. Fornecida em polybag.

∓ 1200 x 900 mm

✂ SCR - 75 x 55 mm



Pedro — 99215

Capa de chuva de tamanho único fornecida dentro de embalagem em formato de bola de futebol com chaveiro e mosquetão.

∓ Ø63 mm | 1200 x 900 mm

✂ PDP - 15 x 15 mm



Isabel — 99214

Capa de chuva de tamanho único, fornecida dentro de embalagem em formato de bola com chaveiro e mosquetão. Embalagem disponível em várias cores.

∓ Ø63 mm | 1200 x 900 mm

✂ DUV - 25 x 25 mm



Forro prateado



Cabo direcionável



Parana — 98320

Guarda-sol reclinável em 210T com forro prateado. Fornecido em bolsa com alça.

∅1400 mm | 1600 mm |

Bolsa: 1010 x 110 mm

TXP – 220 x 140 mm



Dering — 98332

Guarda-sol em poliéster 170T. Fornecido em bolsa.

∅1400 mm | 1600 mm |

Bolsa: 1000 x 120 mm

TXP – 220 x 140 mm



Quando a chuva
passar e o sol
aparecer, aproveite
para se equipar com
o essencial para
a praia



129 106 104



Azur — 98329

Guarda-sol em 300D com interior prateado e cabo direcionável. Fornecido em bolsa.

☒ 1600 x 1600 mm | 1800 mm | Bolsa: 1050 x 130 mm

☒ TRS - 280 x 200 mm

Mantenha o seu celular seguro com capas resistentes à água

A



Permite
utilização touch



A

Permite
utilização touch



Egeu — 98266

Bolsa para celular em PVC impermeável (não aconselhável imersão). A parte frontal é transparente e a parte dianteira é em branco fosco. Permite interagir com o tela a partir do exterior. A bolsa tem fechamento hermético e aba em cor com fechamento em velcro.

▮ 240 x 95 mm

▮ SCR - 60 x 120 mm



Mamore — 58315

Bolsa para celular em PVC. Bolsa impermeável (não aconselhável imersão) que permite utilização touch. Para smartphone 5.5".

▮ 100 x 220 mm

▮ SCR - 60 x 90 mm

Escolha uma das diferentes cores da fita Burton para combinar com o chapéu Manolo



NEW

Burton — 99428

Fita para chapéu em 100% poliéster, disponível para várias cores e de fácil personalização.

☒ 650 x 24 mm

✂ TRS - 380 x 18 mm



Manolo — 99427

Chapéu em PP, disponível em várias cores. Fita não incluída.

☒ Tamanho: 58

✂

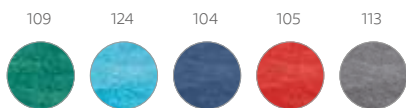

Sardegna — 98375

Toalha de praia em veludo de algodão (320 g/m²), disponível em várias cores. Fornecida com sacola em non-woven (80 g/m²).

☒ 1500 x 750 mm | Sacola: 330 x 415 x 100 mm

✂ TRS – 280 x 200 mm



A



California — 58377

Toalha de praia em microfibra (250 g/m²). Fornecida com sacola em non-woven (80 g/m²).

☒ 1500 x 750 mm | Sacola: 330 x 415 x 100 mm

✂ TRS – 280 x 200 mm



Galapos — 98247

Sacola almofada inflável em PVC opaco.

☒ Vazio: 300 x 320 mm

✂ SCR – 160 x 160 mm



ECÓlogic



Ville — 92824

Sacola 100% algodão canvas (280 g/m²) com bolso frontal e bolso interior com zíper. A sacola contém fecho magnético e alças de 60 cm.

☒ 530 x 380 x 170 mm

☒ TRS – 120 x 150 mm



Kenza — 98424

Sacola de praia em 600D e alça de corda em algodão.

☒ 510 x 440 x 140 mm

☒ TRS – 280 x 200 mm

Lolla —
98417

☒ .312



Edmonton —
92822

☒ .298



Bolso interior



104



106

Maresia — 92513

Sacola de praia em 300D com bolso interior. Alças em webbing de 70 cm.

☒ 450 x 300 x 80 mm

☒ TRS – 240 x 200 mm



Índice remissivo

Abridor de garrafas	274	Conjunto de desenho	373	Lápis	156, 374
Adaptador USB	98, 101	Conjunto de esferográfica e lapiseira	118, 138, 140	Lápis para colorir	157, 373, 374
Álcool Gel	218	Conjunto de porta copos	268	Luminária de mesa	53, 75, 87
Alicate	367	Conjunto de roller e esferográfica	112 - 116, 118	Luminária de mesa com caixa de som	53, 87
Almofada de pescoço	221	Conjunto de talheres	250, 278	Luva refrigeradora	271, 272
Ampulheta de banho	214	Conjunto para vinho	269, 271	Mala de cosméticos	170
Anti-estresse	223	Copo de viagem	217, 321, 323, 329, 346 - 353, 378	Mala de viagem	170
Apontador	375	Copo para salada	283	Mala de viagem executivo	167 - 171
Avental	284 - 286	Copos	321, 322, 348, 352	Manta	225, 288
Avental de criança para colorir	378, 379	Cortador de pizza	282	Marmita	264, 265, 279 - 282
Banda elástica refletora	224	Dema	143 - 145	Máscara para dormir	221
Base de mesa	255	Dispenser automático	219	Mini lápis	156
Bateria portátil	72, 89 - 96	ekston®	63 - 69	Mochila	176, 180 - 199, 313, 380
Blocos adesivados	48 - 51	Embalagem para esferográfica	132	Mochila para notebook	176 - 192
Bolsa de cintura	193	Embalagem para pastas A4	58	Mochila trolley para notebook	167, 172, 173, 177
Bolsa de cosméticos	205, 206, 208 - 211, 213	Esferográficas	112 - 141, 148	Mosquetão	244, 368
Bolsa de cosméticos hermética	212	Espelho de maquiagem	214, 215	Mouse wireless	100
Bolsa esportiva	180, 192, 195	Estação de carregamento USB	98	Óculos de realidade virtual	86
Bolsa multiusos	207, 210, 211	Esteira para grelha	263	Organizador de mesa	73
Bolsa para bicicleta	364	Estojo para esferográficas	132, 133	Pasta à tiracolo	191
Bolsa para celular	400	Estojo para lápis	376, 377	Pasta A4	52, 54, 56, 57, 58
Bolsa para notebook	106	Faca	228	Pasta A5	54, 57
Bolsa para sapatos	222	Fita para chapéu panamá	401	Pasta de congresso	200, 202
Bolsa térmica	312, 313, 315, 316, 381	Fone de ouvido	76 - 81	Pasta multifunções	200
Bolsa térmica dobrável	316	Fones de ouvido dobráveis	76, 78	Pasta para notebook	106, 190, 201
Bolsas	213, 246, 277	Fones de ouvido wireless	81	Pasta porta-documentos A4	52
Borracha	158, 375	Frasco com doseador	218	Pen Drive	97
Braçadeira para celular	364	Frasco de vidro	267	Pochete	193, 198
branve®	22 - 25, 108, 110, 161 - 165	Galheteiro	254	Porta cartões	48, 102, 103, 234, 246
Bule	323	Garrafa de vidro	267, 325	Porta celular para carros	104
Cabos USB	100	Garrafa térmica	321, 343	Porta comprimidos	216
Cadeira dobrável	225	Guarda-chuva	385, 386, 388 - 395	Porta copos	268, 274
Caderno	26 - 48, 51, 55, 88	Guarda-chuva para criança	382, 396	Porta crachás	51
Caderno para colorir	372	Guarda-sol	398, 399	Prato	254
Cafeteira	322	Hub USB 2.0	100	Protetor para webcam	105
Caixa	36, 358	Identificador de bagagem	220	Protetor solar para carros	224
Caixa de cartão com giz de cera	372	Kit churrasco	251, 256 - 263	Punho elástico	364
Caixa de cartão com lápis de cor	371	Kit de Cocktail	277	Régua	376
Caixa de cartão com mini lápis	371, 373	Kit de costura	222	Relógio	72
Caixa de chás	268	Kit de escrita	34, 157, 373, 376	Rolha de vácuo para garrafa	272
Caixa de som	72, 74, 75, 82 - 85	Kit de escritório	34, 37	roller	112, 116, 119, 123, 126, 128
Caixa esterilizadora	86, 219	Kit de ferramentas	366	Saca-rolhas	269, 271, 275
Caixa para pen drive	97	Kit de higiene para cachorro	224	Sacola	198, 254, 272, 273, 291, 292 - 316, 402, 403
Caneca	322, 348	Kit de jardinagem	287	Sacola de praia	403
Caneca para viagem	348	Kit de limpeza de sapatos	222	Sacola esportiva	174
Canivete	226 - 228, 367	Kit de lixas	214	Sacola tipo mochila	174, 292, 299 - 307, 363, 378, 379
Canudo	276	Kit de manicure	214, 215	Saladeira	250
Canudos	276, 278	Kit de porta cartões e chaveiro	233	Saleiro	254
Capa de chuva	387, 389, 397	Kit de porta cartões, chaveiro e esferográfica	233	Shaker	360
Capas	35	Kit de toalha e garrafa	362	Squeeze	319, 321 - 359
Carregador wireless	73, 74, 99	Kit de viagem	221	Suco®	6 - 17
Chapéu	401	Kit esferográfica e chaveiro	232	Toalha de praia	390 - 402
Chaveiro	231, 232, 235 - 245	Kit fitness	365	Toalha para esporte	362
Coletes	363, 379	Kit para escritório	49	Top Pen	147 - 155
Coluna de som	71	Kit para pintar em caixa de cartão	372	Travessa	255
Conjunto de canudo	277, 278	Lanterna	242, 243		

Legenda de ícones

	100% algodão		BPA Free		Género feminino		Produto ECO
	140 folhas		Capacidade L		Guarda-chuva automático		Produto patenteado
	À prova de água		Capacidade mL		Guarda-chuva com varetas de fibra		Proteção térmica
	Aço inox		Comprimento do cabo		Imã		rPET
	Algodão orgânico		Elementos refletores		Lapiseira 0.5		Tamanho A4
	Algodão reciclado		Escrita a azul		Lapiseira 0.7		Tamanho A5
	Alta capacidade		Escrita a preto		Laser		Tamanho A6
	Apropriado para bebidas frias		Escrita a preto, azul e vermelho		LED		Tamanho A7
	Apropriado para bebidas quentes		Folhas não pautadas		LED COB		Tamanho B6
	Apropriado para comida		Folhas não pautadas cor marfim		Leitor de cartões TF		Tamanho B7
	Apropriado para congelador		Folhas pautadas		Pannel solar		Tamanho de bolso
	Apropriado para máquina de lavar		Folhas pautadas cor marfim		Pega com mola		Transmissão por bluetooth
	Apropriado para microondas		Folhas pontilhadas cor marfim		Polegadas para notebook		Tratamento antibacteriano
	Bloqueio RFID		Fornecido em caixa presente		Produto amigo do ambiente		Unissex

Códigos de cor

	102 Rosa		113 Cinza		132 Roxo
	103 Preto		114 Azulroyal		133 Cinza escuro
	104 Azul		119 Verde claro		134 Azul marinho
	105 Vermelho		122 Rosa escuro		137 Dourado satinado
	106 Branco		123 Cinza claro		139 Verde lima
	107 Cromado		124 Azul claro		144 Turquesa
	108 Amarelo		127 Cromado satinado		147 Chumbo
	109 Verde		128 Laranja		160 Natural
	110 Transparente		131 Bege		167 Champanhe

Advertimos para o fato da reprodução gráfica das fotografias poder causar diferenças de tonalidades em relação à cor dos produtos. As dimensões dos produtos e respetivas áreas de personalização recomendadas são meramente indicativas, podendo sofrer alterações sem aviso prévio.

Índice: Nome — Referência

Abe — 91968	132	Bernal — 99969	362	Chastain — 92737	213	Eindhoven — 92145	172	Hassi — 94676	349
Adams A5 — 93719	28	Bertle — 92635	199	Chaucer — 93497	34	Eliot — 93792	49	Healy 5L — 94895	218
Adams A6 — 93720	28	Beta Bamboo — 81011	137	Chert — 94018	366	Eliza — 92731	208	Healy 60 — 94892	218
Adventure — 92174	182	Beta Soft — 81141	201	Chicago — 92258	131	Elliot — 81009	137	Healy 100 — 94893	218
Aerial — 94092	276	Beto — 92820	297	Chicory — 99835	286	Elora — 94300	134	Healy 500 — 94894	218
Aerial Wide — 94094	276	Betsey — 99100	393	Chill — 98054	223	Emerge A5 Folder — 93581	55	Hearkeen — 97919	66
Agua — 53621	375	Bielo — 92038	56	Chion — 97396	83	Emerge A5 Folder — 93581	88	Heat — 94667	343
Alberta — 99145	388	Bilbao — 92848	311	Chives — 99822	284	Emily — 98111	220	Heiden — 99078	288
Alcott A4 — 93272	47	Bilbo — 94879	222	Christie — 92058	54	Emilyn — 97384	92	Helli — 93394	238
Alcott A5 — 93273	47	Billy II — 54957	336	Cilantro — 93854	280	Emmy — 97153	100	Henderson — 94264	342
Alcott A6 — 93274	47	Bio — 91291	352	Cinnamon — 94626	141	Empire Backpack — 92680	162	Hera — 81163	138
Aldrin X — 57904	90	Bird — 51750	371	City — 92665	196	Empire Notebook — 93598	23	Hexa — 92288	192
Alecran — 97399	100	Birmingham — 52637	187	Clane — 94195	244	Empire Suitcase I — 92360	163	Hexa Sport — 92515	192
Alicante — 92911	306	Bissaya — 92617	379	Clare — 81156	122	Empire Suitcase II — 92359	163	Hibiscus — 93978	268
Alick — 94035	226	Bit — 97162 / 97941 / 97944	96	Clark — 92041	56	Erald — 94623	339	Himalayas — 94664	348
Alioli — 94139	258	Blackwall — 93353	235	Cleat — 93360	242	Eraster — 51721	136	Holly — 57335	84
Alioli Board — 94143	258	Blackwell 2.4 — 57304	100	Close — 98824	244	Euclidean — 57340	84	Holz — 94134	274
Alioli King — 94140	258	Blake — 93367	238	Close — 98824	368	Euna — 94852	214	Homier — 93167	240
Almodovar — 93489	28	Blanchett — 92735	206	Clouds — 94632	356	Evo Mm — 31013	143	Hoole — 97367	104
Aloy — 95050	231	Blare — 97257	67	Coast — 98425	314	Expresso — 93873	322	Hook Matte — 81003	110
Alps — 91333	129	Blazon — 81147	119	Cobb — 98117	222	Ezekiel — 81195	112	Hopper — 57935	77
Alsi — 94051	279	Blend — 94247	271	Coben — 93474	30	Ezekiel Roller — 81196	112	Horde — 97921	68
Americano — 94785	322	Block — 93334	103	Cobra — 92090	167	Ezekiel Set — 81210	112	Horus 1 — 94650	358
Amora — 30512	17	Blug — 98067	223	Collina — 94246	339	Fabrís — 93829	254	Horus 2 — 94651	358
Amora Wh — 30513	17	Bocage — 92045	306	Colmar — 92912	56	Falcon II — 94031	227	Horus 3 — 94652	358
Amora Women — 30514	17	Bocuse — 93853	281	Colombia — 94194	272	Farday — 57360	80	Horus 4 — 94653	358
Amora Women Wh — 30515	17	Bolzano — 92934	305	Colorit — 93619	376	Faulkner — 93794	50	Horus 5 — 94654	358
Amorti — 94958	333	Bondi — 92821	296	Coloured — 51747	371	Felipe — 99130	389	Horus 6 — 94655	358
Amy — 81115	152	Boole 1.5 — 97946	96	Confor — 97207	364	Feria — 92869	294	Hous — 98057	223
Ancer — 94687	357	Boracay — 52085	189	Conley — 94621	359	Findo — 98124	220	Hubble — 97076	94
Angela — 99146	388	Borba — 92819	273	Cooper — 93791	49	Fit — 92511	195	Hugo — 93591	33
Angle Bpack — 92270	181	Bosi — 99814	308	Cooper — 93717	40	Fitch Eco — 57909	72	Hummingbird — 93614	376
Anim — 51758	372	Boston — 92675	176	Cork — 81401	134	Fitzgerald — 92040	58	Hygge — 94678	346
Aniston — 94856	214	Botaly — 94144	263	Corks — 93145	232	Flaubert — 93709	48	Hyper — 57906	99
Anjelica — 92716	211	Bottura — 93844	259	Cornish — 93428	44	Flemi — 93397	239	Ilford — 92914	299
Annatto — 94141	260	Bourchier — 93363	235	Cornwell — 51716	156	Forey II — 57252	85	Ingrid I — 92733	213
Annie — 92717	211	Bouvier — 93729	39	Cotia — 92723	209	Florian — 98514	224	Ingrid II — 92734	213
Apolo — 99149	387	Bow — 97328	84	Coulomb 4.0 — 57344	91	Fortaleza — 52081	177	Inky — 91847	130
April — 92545	193	Boxp — 92904	307	Covent — 92847	311	Fortier Tw — 57938	176	Iruilan — 92630	58
Arasta — 92924	309	Boyd — 93276	31	Crafti — 51931	371	Franck — 93331	103	Isabel — 99214	397
Arky — 92166	181	Brady — 98086	365	Creta — 92085	189	Frankfurt — 92156	200	Istanbul — 92083	307
Arleta — 92859	309	Braga — 92823	293	Crick 2.4 — 57398	100	Fred — 94037	226	Izmir — 98409	316
Artx — 99968	362	Bramble — 94043	277	Cricket — 51752	373	Freud — 93578	229	Jacky — 81119	155
Artx Plus — 99967	362	Bree — 92852	210	Croco — 51746	371	Froome — 93396	237	Jacky Bk — 81120	154
Arisimov — 93715	44	Brem — 92182	188	Crowd — 97917	69	Funfaye — 94116	274	Jaguar — 51755	372
Atala — 94101	263	Brendon — 93315	233	Crowe — 92715	208	Gabro — 94017	366	Jaipur — 98408	313
Ateneo — 51736	156	Bresset — 98823	368	Cubot — 94138	262	Gagarin — 97394	95	Jame — 93448	51
Ateneo — 51736	374	Brighter — 94746	242	Cuckoo — 93466	372	Galapos — 98247	402	Jamp — 93155	239
Atwood A5 — 93492	42	Bronte — 93422	48	Cuppa — 94058	351	Galilei — 97951	105	Janne — 97318	100
Atwood A6 — 93493	42	Brooklyn — 92081	177	Cuvier II — 57929	74	Galois — 57930	75	Jasmin 800 — 94235	267
Atwood B6 — 93723	42	Bruges 33L — 92159	169	Dakar — 94699	324	Garbi — 92197	201	Jasmin 800 — 94235	325
Austen — 51917	158	Bruges 90L — 92297	169	Dale — 92916	308	Garcia — 93827	268	Jasmin 1000 — 94236	267
Autograph — 81205	108	Brussels — 92169	192	Daneý — 81155	126	Garden — 93708	44	Jasmin 1000 — 94236	325
Aveiro — 92176	181	Buenos Aires — 92186	170	Dante — 91491	129	Gardner — 97357	100	Jay — 94061	359
Avenir — 92177	173	Buffon — 94078	331	Darwin II — 57390	72	Garlic — 94145	256	Jeddah — 98406	316
Avery — 92352	106	Bulfinch — 93461	46	Day — 97371	93	Garlic King — 94142	256	Jenna — 99137	390
Avila — 91492	128	Burnell Bk — 57908	99	Decop — 94689	361	Gauteng — 92638	198	Jenson — 94237	320
Azofi — 97079	90	Burpee — 99970	365	Deep — 98012	223	Gauthier — 93967	268	Jerome — 92883	273
Azur — 98329	399	Burton — 99428	401	Deli — 91814	120	Gavis — 94835	214	Jimmy — 94305	216
Bachmann — 93171	236	Cabernet — 94190	269	Denim — 93594	33	Gent — 57395	82	Joan — 91694	130
Bacuri — 94691	351	Caine — 57326	98	Deniro — 92722	212	Geometric Notebook — 93596	24	Jolly — 57907	99
Bago — 92517	195	Cairo — 92084	302	Denver — 92321	188	Georges — 97150	104	Julep — 94090	276
Bahia — 91820	137	California — 58377	402	Derby — 92523	185	Germout — 58519	86	Julie — 81144	123
Baird — 92844	272	Caliope — 81197	116	Dering — 98332	398	Germout — 58519	219	Jullemier — 94137	262
Baitt — 93151	244	Caliope Roller — 81198	116	Descry — 97922	64	Gilded — 94690	361	Kafka — 93712	36
Bale — 93143	236	Caliope Set — 81199	116	Dhabi — 94668	327	Ginger — 99830	284	Kahana — 94096	276
Baloo — 52619	378	Campanela — 99151	395	Diamond — 93395	237	Giraffe — 54635	378	Kahana Wide — 94095	276
Bambi — 99133	382	Canary — 92839	310	Dickens A5 — 93485	45	Giraldo — 92520	195	Kandel — 97912	81
Bambi — 99133	396	Canna — 94638	350	Dickens A6 — 93486	45	Glashow Eco — 57256	72	Kardon — 52627	184
Bambu — 91378	141	Canola — 94053	279	Dill — 93848	280	Gobo — 94006	242	Karen — 99115	390
Bangkok — 92636	186	Capers — 93966	253	Doha — 92236	200	Goiba — 30508	15	Karl — 99122	391
Bannon — 57365	78	Cappero — 94028	253	Doublette — 91844	118	Goiba Wh — 30509	15	Karpov — 94610	342

Lambda 4.0 — 97943	0.94	Millard — 93280	0.234	Pati — 81153	0.141	Sablon — 92919	0.292	Tilly — 97095	0.71
Lamone — 94098	0.278	Millau — 95051	0.231	Patti — 99116	0.392	Saffron — 93847	0.280	Tilt Bc — 31018	0.145
Lana — 81122	0.150	Miller — 93124	0.246	Paw — 93364	0.240	Sagan — 97077	0.95	Tilt Bt — 31019	0.145
Lana Frost — 81124	0.150	Milli — 92148	0.209	Pedro — 99275	0.397	Salinger — 92068	0.57	Tilt Eco — 31020	0.145
Lana White — 81123	0.150	Millie — 92077	0.207	Pemba — 92931	0.304	Sally — 81107	0.149	Tisana — 94636	0.350
Lando — 81190	0.128	Milo — 92316	0.202	Pendolo — 91970	0.133	Sally Frost — 81108	0.149	Titus 1 — 94656	0.358
Lando Roller — 81191	0.128	Milton — 93476	0.51	Penrose — 97517 / 97528 / 97529	0.97	Salvy — 93969	0.250	Titus 2 — 94657	0.358
Langford — 94960	0.338	Milu — 81113	0.153	Pepe — 94620	0.354	Samoura — 93851	0.281	Titus 3 — 94658	0.358
Lapoint — 81201	0.121	Milu Frost — 81109	0.153	Pepper — 93968	0.250	Sandra — 99213	0.397	Titus 4 — 94659	0.358
Latte — 94067	0.350	Minsky — 97090	0.101	Perry — 57253	0.84	Santana — 92266	0.190	Titus 5 — 94670	0.358
Launay — 94686	0.360	Miro — 91444	0.125	Perth — 92160	0.168	Sardagna — 98375	0.402	Tizzy — 92828	0.293
Lavender — 99826	0.379	Mobby — 93165	0.240	Pertina — 92998	0.311	Sawgrass — 92850	0.308	Toffa — 94066	0.350
Laver — 94257	0.319	Modric — 94694	0.353	Pessoa — 93734	0.35	Schooli — 93607	0.377	Tokev — 93870	0.282
Lavre — 93324	0.232	Modric L — 94695	0.353	Peter — 93718	0.50	Screbe — 94729	0.243	Tomas — 99139	0.394
Lawrence — 94030	0.227	Monarda — 94681	0.349	Petrelli — 94637	0.352	Script — 91494	0.124	Torchen — 93267	0.243
Lea — 51125	0.122	Monco — 92836	0.254	Phelps — 94772	0.347	Seattle — 92290	0.106	Tordo — 93593	0.283
Leaf — 91846	0.140	Mondrian — 93577	0.31	Phladel — 98420	0.313	Sebastian — 98416	0.381	Toronto — 92568	0.198
Leavitt II — 57940	0.73	Monet — 91792	0.117	Phuket — 92138	0.171	Senna — 94782	0.355	Touch — 51437	0.123
Leif — 93154	0.243	Moniz — 97950	0.105	Picchu — 99023	0.364	Seoul — 92257	0.200	Town — 94629	0.356
Lello — 91973	0.132	Montigny — 97389	0.254	Pickled — 93885	0.255	Serena — 94618	0.357	Traveller — 92674	0.182
Lemon — 94649	0.340	Montreal — 51348	0.120	Pietro — 94241	0.321	Serpa — 92069	0.52	Travelx — 98197	0.221
Leo 1.8 — 97376	0.96	Moraes — 93714	0.34	Pisani — 93828	0.268	Serrat — 91392	0.126	Travis — 99966	0.362
Leo 2.2 — 57323	0.96	Moreto — 94119	0.269	Pitanga — 30500	0.269	Sesame — 93831	0.255	Travolta — 93314	0.233
Lergan — 93141	0.242	Moriah — 93799	0.36	Pitanga Wh — 30501	0.13	Sessil — 99155	0.389	Trencher — 97925	0.69
Leskov — 93370	0.236	Mosfet — 97525 / 97541	0.97	Pitanga Women — 30502	0.13	Shades Bpack — 92170	0.191	Trotte — 95103	0.224
Lesley Metallic — 81185	0.127	Motion Backpack — 92681	0.165	Pitanga Women Wh — 30503	0.13	Shades Cross — 92173	0.191	Trudy — 93398	0.245
Lesini — 94110	0.250	Motion Bag — 92521	0.165	Piyon — 57936	0.74	Shades Plate — 52170	0.191	Tupi — 92167	0.180
Lewis — 93426	0.48	Motto — 57911	0.73	Plata — 91008	0.120	Shakespeare — 93789	0.37	Turim — 92471	0.196
Lezzo — 58517	0.53	Mounti — 92628	0.194	Plock — 91834	0.118	Shanghai — 91476	0.124	Turmeric — 53878	0.283
Lezzo — 58517	0.75	Moura — 92129	0.170	Poe — 92046	0.52	Shanti — 92827	0.293	Turtle — 58412	0.381
Lillard — 94770	0.324	Moussaka — 94107	0.256	Poodle — 51756	0.373	Shaw — 93795	0.37	Uler — 57338	0.104
Limardo — 98822	0.368	Muller — 93332	0.103	Poppins — 51140	0.131	Shelley — 93320	0.102	Ulrich — 93084	0.238
Lippia — 94780	0.282	Muller — 93332	0.234	Popsy — 93265	0.103	Shino — 94025	0.265	Urban Backpack — 92683	0.164
Lispector — 93724	0.35	Mumbai — 92927	0.295	Popsy — 93265	0.234	Show — 94550	0.332	Uruguay — 92140	0.167
Liter — 94679	0.343	Munich — 92569	0.198	Portel A5 — 93730	0.28	Show Satin — 94771	0.332	Valastro — 94109	0.260
Logan — 52635	0.199	Muniqué — 92322	0.179	Portel A6 — 93731	0.28	Siderot — 94688	0.338	Valentina — 92720	0.212
Lohan — 98091	0.223	Murciel — 39000	0.395	Portis — 94630	0.359	Sign I — 81206	0.108	Valley — 94068	0.350
Lolla — 98417	0.312	Mustard — 93861	0.255	Portobello — 94781	0.264	Sign II — 81207	0.108	Verbena — 93977	0.268
Lone — 93318	0.234	Muzeul — 92544	0.193	Puzo — 93463	0.52	Signy — 97348	0.97	Verber — 94192	0.228
Lopez — 94857	0.214	Nadal — 94769	0.217	Pynchon — 92066	0.57	Silver Stripe — 99153	0.389	Verentino — 93892	0.272
Loren — 92713	0.210	Nadia — 94843	0.214	Queta — 94250	0.337	Silvanio — 81170	0.129	Verona — 92089	0.178
Louvre — 91489	0.113	Naeker — 99824	0.284	Queta soft — 94256	0.337	Simon 8Gb — 97434	0.127	Versailles — 81146	0.113
Luka — 94615	0.342	Nampula — 92933	0.300	Quiver — 94093	0.276	Sinatra — 51837	0.94	Vibration — 97923	0.66
Lumina X — 97945	0.92	Napoli — 92935	0.295	Ragnar — 94602	0.334	Singapore — 98418	0.313	Victoria — 92415	0.296
Lunar — 92164	0.186	Nate — 53197	0.245	Raise — 94646	0.326	Siza — 51935	0.158	Viena — 92179	0.188
Lunkina — 94768	0.322	Natura — 91647	0.134	Raldic — 93371	0.231	Siza — 51935	0.375	Vigo — 92144	0.167
Luton — 98414	0.312	Naturel — 94683	0.321	Raman Bk — 57905	0.92	Slater — 91843	0.92	Vila — 91960	0.132
Lycya — 94761	0.321	Neeson — 98093	0.223	Ravioli — 94102	0.263	Sketch — 94062	0.263	Ville — 92824	0.298
Lyme — 91338	0.126	Neo — 81001	0.110	Recicla — 91290	0.141	Slider — 94242	0.141	Ville — 92824	0.403
Lynne — 94056	0.278	Nero — 94307	0.216	Reds — 98059	0.223	Smartpepper — 93989	0.257	Vivre — 93392	0.241
Lyon — 92320	0.178	Neruda — 93275	0.26	Redy — 57362	0.98	Smith — 93308	0.98	Volter — 81014	0.139
Lyze II — 92725	0.218	Nerval — 93270	0.32	Reflask 500 — 94913	0.218	Snead — 94238	0.224	Wagner — 93341	0.239
Macabeu — 94193	0.272	Nesbit II — 54743	0.53	Regent — 92414	0.296	Sobral — 99141	0.296	Wallis — 97366	0.104
Mace — 93845	0.260	Nesbit II — 54743	0.87	Reina — 93850	0.264	Solberg — 94240	0.333	Warhol — 51836	0.115
Macy — 92854	0.310	New Star Eco — 31022	0.145	Renewal Battery — 97094	0.89	Sow — 94239	0.319	Warmy — 99071	0.288
Magnet — 97920	0.68	Newton II — 57312	0.98	Renewal Charger — 97093	0.89	Spacio — 52675	0.176	Wass — 81000	0.127
Magnum — 94022	0.367	Nicholas — 99143	0.393	Renó — 99043	0.391	Speare — 91969	0.133	Wass Touch — 81005	0.123
Malcarova — 94765	0.321	Nicolous — 94446	0.102	Repairuse Backpack — 92080	0.174	Spice 380 — 94099	0.267	Watters — 93269	0.41
Malbec — 94117	0.275	Nicolous — 94446	0.246	Repairuse Bag — 92078	0.205	Spice 700 — 94079	0.267	Wave Cc — 31011	0.144
Malte — 94115	0.274	Nicole — 81010	0.137	Repairuse Cooler — 98427	0.315	Spirited — 97205	0.364	Wave Frost — 31012	0.144
Malvia — 93975	0.252	Ninja — 94036	0.226	Repairuse Sports — 92079	0.174	Split — 94038	0.227	Wave Mm — 31010	0.144
Manore — 58315	0.400	Nisa — 92274	0.201	Rhombus — 51932	0.157	Sporty — 94633	0.338	Wayne — 92732	0.208
Manaus — 92163	0.186	Noah — 94608	0.348	Rhombus — 51932	0.373	Stain — 81208	0.373	Weida — 92719	0.210
Manolo — 99427	0.401	Norre Bottle — 94662	0.329	Ringbolt — 93368	0.238	Stella — 99147	0.395	Weinberg — 97527 / 97543	0.97
Maputo — 92929	0.304	Norre Tumbler — 94661	0.329	Ringrod — 93427	0.44	Stephenie — 53565	0.376	Wellington — 92087	0.183
Marbella — 92938	0.197	Norris — 94032	0.228	Rio — 94059	0.341	Steven — 57154	0.98	Werner — 94666	0.348
Marcconi — 57939	0.76	Note — 92283	0.172	Riordan — 92067	0.57	Stiller — 94301	0.216	Wharf — 92902	0.296
Mare — 91434	0.129	Nurmi — 94619	0.360	Rissani — 92936	0.301	Stitch — 93356	0.201	Whidy — 94953	0.219
Maresia — 92513	0.403	Odin — 94603	0.331	Rizzoli — 51738	0.157	Stooky — 93421	0.51	Wild — 94040	0.228
Margot — 92741	0.213	Odrein — 94622	0.359	Rizzoli — 51738	0.374	Stork — 99123	0.382	Wilkins — 97341	0.79
Maria — 99138	0.394	Olaf Soft — 81192	0.131	Roberto — 99109	0.391	Stork — 99123	0.391	Williams — 94669	0.327
Marie — 92721	0.211	Olympia — 92276	0.184	Roberts — 94306	0.216	Strada — 98180	0.216	Willis — 92724	0.209
Marjoram — 94261	0.251	Olympia Plate — 52276	0.184	Rocco — 92626	0.184	Stratford — 92499	0.310	Wiltz — 92168	0.191
Marley — 81118	0.154	Omar 2.0 — 57391	0.94	Rock — 93419	0.45	Streep — 94853	0.215	Winery — 94248	0.271
Marlowe — 93707	0.44	Orchid — 98129	0.287	Rocket — 92614	0.380	Stuart — 99142	0.390	Wings — 94614	0.348
Marvay — 92825	0.297	Orlando — 81193	0.115	Rodari — 93739	0.38	Sulena — 99051	0.288	Wiretap — 97926	0.64
Masai — 91383	0.140	Orleans — 92922	0.294	Roger — 98504	0.363	Sunflower — 99813	0.285	Woodbury — 92832	0.308
Matira — 99965	0.362	Orton — 94696	0.353	Rols — 51751	0.373	Sunshade — 98191	0.224	Woods — 93830	0.252
Matisse — 93087	0.27	Orton L — 94697	0.353	Romford — 92913	0.299	Suya — 94077	0.278	Yates — 92799	0.364
Matola — 92932	0.300	Osaka — 98413	0.316	Ronde — 94677	0.346	Sydney — 99277	0.85	Yeats — 53569	0.51
Maxwell — 57932	0.74	Osasco — 92637	0.187	Rosat — 97952	0.105	Syrah — 94189	0.269	Yellowstone — 98503	0.363
Mayer — 97098	0.71	Oscar II — 52075	0.54	Ross — 81106	0.147	Tahini — 94055	0.278	Yglo — 93620	0.375
Meyfair — 98423	0.311	Osler — 97092	0.80	Rossi — 94069	0.345	Tanat — 94103	0.345	York — 98428	0.315
Medan — 98411	0.316	Otao — 93852	0.358	Roterdam — 92845	0.310	Tangram — 92291	0.270	Zabel — 93158	0.238
Medley — 57914	0.79	Othmer — 94644	0.356	Roth — 93592	0.39	Tarragon — 93899	0.282	Zack 7.2 — 57351	0.92
Megan — 99152	0.390	Ottoflex — 57913	0.79	Rotterdam — 98410	0.316	Tazy — 93735	0.48	Zagazig — 92677	0.185
Melville — 98415	0.312	Ozma — 91972	0.36	Rousseau — 93268	0.26	Teriyaki — 94104	0.257	Zamba — 94057	0.277
Memphis — 52856	0.308	Padova — 92937	0.291	Roy — 81121	0.151	Them — 98502	0.363	Zena — 94897	0.215
Mercat — 92882	0.292	Palermo — 93976	0.252	Rozier — 94648	0.354	Thiker I — 57431	0.63	Zimbro — 99812	0.284
Merlot — 94249	0.271	Pantani — 93140	0.243	Rubin — 57934	0.81	Thiker II — 97431	0.63	Zippers Bpack — 92280	0.180
Metronome — 97429	0.63	Papaya — 30504	0.11	Rubins — 97091	0.101	Think — 97916	0.69	Zippers Plate — 52280	0.180
Mexico — 92323	0.303	Papaya Wh — 30505	0.11	Rubin Wh — 57937	0.81	Thorpe — 99074	0.225	Zippers Sport — 92516	0.180
Meyer — 93425	0.43	Papaya Women — 30506	0.11	Ruiz — 93722	0.40	Throne — 98131	0.225	Zoe — 91624	0.125
Miami — 92293	0.173	Papaya Women Wh — 30507	0.11	Rules — 92835	0.306	Thunder — 97258	0.67		
Michael — 99134	0.393	Paprika — 93898	0.255	Rules — 92835	0.363	Tiget — 99135	0.394		
Mike — 98501	0.363	Parana — 98320	0.398	Russel — 93788	0.35	Tilbury — 94898	0.215		
Mike — 98501	0.379	Paszo — 92044	0.54	Rynek — 92920	0.301	Tiles Notebook — 93737	0.25		

	MOCHILAS	Pág. 6
	MALAS	Pág. 48
	BOLSAS E MALAS ESPORTIVAS	Pág. 56
	NECESSAIRES	Pág. 62
	BOLSA TÉRMICA	Pág. 68
	PASTAS	Pág. 74
	GARRAFAS	Pág. 76
	COPOS E CANECAS	Pág. 104
	ESCRITÓRIO	Pág. 120
	CANETAS SUSTENTÁVEIS	Pág. 152
	CANETAS PLÁSTICAS	Pág. 158
	CANETAS SEMI-METAL	Pág. 162
	CANETAS METÁLICA	Pág. 168
	ESTOJOS	Pág. 182
	CHAVEIROS	Pág. 184
	DIVERSOS	Pág. 190
	KIT CHURRASCO	Pág. 192
	KIT QUEIJO	Pág. 198
	LANCHEIRAS	Pág. 202
	GUARDA-CHUVA	Pág. 204

MOCHILAS





MC380

Mochila em poliéster com porta notebook e alça de mão na lateral

Dimensões: 49x26x17cm

Peso unit.: 0,834kg

MOCHILAS



MC370

Mochila em poliéster com porta notebook e conector USB

Dimensões: 45x28x12cm

Peso unit.: 0,622kg



MC360

Mochila e Pasta com porta notebook

Dimensões: 40x29x10,5cm

Peso unit.: 0,818kg

MOCHILAS



MC430

Mochila e pasta com porta notebook

Dimensões: 44x31x11cm

Peso unit.: 0,410kg



MC221

Mochila e Pasta com porta notebook

Dimensões: 43x32x10cm

Peso unit.: 0,810kg

MOCHILAS



MC222

Mochila em nylon com porta notebook

Dimensões: 31x45x9cm

Peso unit.: 0,650kg



MC223

Mochila em poliéster com porta notebook
Dimensões: 31x45x9cm
Peso unit.: 0,660kg

MOCHILAS



MC400

Mochila em poliéster com porta notebook

Dimensões: 49x34x19cm

Peso unit.: 0,908kg



MC209

Mochila executiva robusta com porta notebook

Dimensões: 47x31x22cm

Peso unit.: 1,3kg

MOCHILAS



MC206

Mochila executiva com porta notebook

Dimensões: 44x30x18cm

Peso unit.: 0,900kg



MC205

Mochila executiva com bolso térmico e porta notebook

Dimensões: 50x35x25cm

Peso unit.: 0,880kg

MOCHILAS



MC260

**Mochila executiva com rodinhas
e porta notebook**

Dimensões: 31x18x43 cm

Peso unit.: 1,720 kg



MC204

Mochila executiva com rodinhas e porta notebook

Dimensões: 45x33x20cm

Peso unit.: 2,012kg

MOCHILAS





MC340

Mochila em poliéster com porta notebook e cadeado com segredo

Dimensões: 43x29,5x15,5cm

Peso unit.: 0,530kg

MOCHILAS





MC538

Mochila em poliéster com porta notebook e cadeado com segredo

Dimensões: 45x14x28cm

Peso unit.: 0,680kg

MOCHILAS





MC240

Mochila antifurto com porta notebook

Dimensões: 44x30x11 cm

Peso unit.: 0,725kg



MC295

Mochila em poliéster com porta notebook

Dimensões: 45x29,5x14cm

Peso unit.: 0,392kg



MC290

Mochila em poliéster

Dimensões: 14x38x30 cm

Peso unit.: 0,330kg

MOCHILAS



MC300

Mochila em poliéster

Dimensões: 42x32x13cm

Peso unit.: 0,410kg



MC305

Mochila em poliéster com porta notebook

Dimensões: 46,5x31x13cm

Peso unit.: 0,436kg

MOCHILAS



MC310

Mochila em poliéster com porta notebook

Dimensões: 39x29x11cm

Peso unit.: 0,512kg



MC320

Mochila em poliéster com porta notebook e conector USB

Dimensões: 39x27,5x11cm

Peso unit.: 0,504kg

MOCHILAS



MC212

Mochila em nylon com porta notebook

Dimensões: 44,5x30x15cm

Peso unit.: 0,590kg



MC213

Mochila em nylon com porta notebook

Dimensões: 47x31x20cm

Peso unit.: 0,490kg

MOCHILAS



MC214

Mochila em nylon com porta notebook

Dimensões: 45x28x12cm

Peso unit.: 0,500kg



MC215

Mochila em nylon com porta notebook

Dimensões: 45x29x18cm

Peso unit.: 0,480kg

MOCHILAS



MC220

Mochila em poliéster com porta notebook

Dimensões: 50x30x11cm

Peso unit.: 0,420kg



MC230

Mochila em poliéster com porta notebook

Dimensões: 45x28x13cm

Peso unit.: 0,500kg

MOCHILAS



MC203

Mochila em poliéster com porta notebook

Dimensões: 44x31x18cm

Peso unit.: 0,527kg



MC250

Mochila em poliéster com porta notebook

Dimensões: 50x30x17cm

Peso unit.: 0,790kg

MOCHILAS



MC330

Mochila em poliéster com porta notebook

Dimensões: 42,5x28,5x15cm

Peso unit.: 0,368kg



MC410

Mochila em poliéster com porta notebook e conector USB

Dimensões: 44x28,5x13cm

Peso unit.: 0,458kg

MOCHILAS



MC420

Mochila em poliéster com porta notebook
Dimensões: 44x29,5x17,5cm
Peso unit.: 0,422kg



MC211

Mochila em poliéster com porta notebook
Dimensões: 44x31x11 cm
Peso unit.: 0,348 kg

MOCHILAS



MC270

Mochila em poliéster com bolso lateral

Dimensões: 40x28x14cm

Peso unit.: 0,310 kg



MC280

Mochila dobrável em poliéster

Dimensões: 46x19,5x14cm

Dimensões produto dobrado: 21x20x5cm

Peso unit.: 0,250kg

MOCHILAS



MC350

Mochila em poliéster com porta notebook

Dimensões: 43x29,5x12cm

Peso unit.: 0,568kg



MC440

Mochila em poliéster
Dimensões: 30x16,5x5,0cm
Peso unit.: 0,140kg





MV800

Mala de viagem pequena

Dimensões aproximada com rodas e alça: 55x22x35cm
Peso unit.: 2,750kg

MALAS





MV900

Mala de viagem pequena dobrável
Dimensões aproximada: 55x9x40cm
Peso unit.: 2,300kg



MV700

Mala de viagem pequena

Dimensões: 37x23x52 cm

Peso unit.: 2,300kg



MV600

Mala viagem pequena

Dimensões com rodas e alça: 55x22x35cm
Peso unit.: 2,750kg

MALAS



MV620

Mala viagem pequena

Dimensões com rodas e alça: 55x22x35cm
Peso unit.: 2,750kg



MV610

Mala viagem média

Dimensões com rodas e alça: 66x25x45cm

Peso unit.: 3.375kg

BOLSAS E MALAS ESPORTIVAS





ME188

Mala esportiva em poliéster

Dimensões: 49x23,5x28cm

Peso unit.: 0,390kg



ME500

Mala esportiva em poliéster

Dimensões: 30x24x53cm

Peso unit.:0,500kg

BOLSAS E MALAS ESPORTIVAS



ME520

Mala esportiva em poliéster

Dimensões: 50x28x22cm

Peso unit.: 0,540kg



ME510

Mala esportiva em poliéster

Dimensões: 48,5x28x24cm

Peso unit.: 0,352kg

BOLSAS E MALAS ESPORTIVAS



BP2000

Bolsa em nylon

Dimensões: 44,5x30x13cm

Peso unit.: 0,240kg



BTN001

Sacola TNT 100gr, alça inteira 60cm

Dimensões: 41,5x37,5cm

Peso unit.: 0,042kg



BP0002

Mochila Saco em poliéster com bolso

Dimensões: 43x32cm

Peso unit.: 0,050 kg



BP0001

Mochila saco em poliéster sem bolso

Dimensões: 40,5x35cm

Peso unit.: 0,025kg

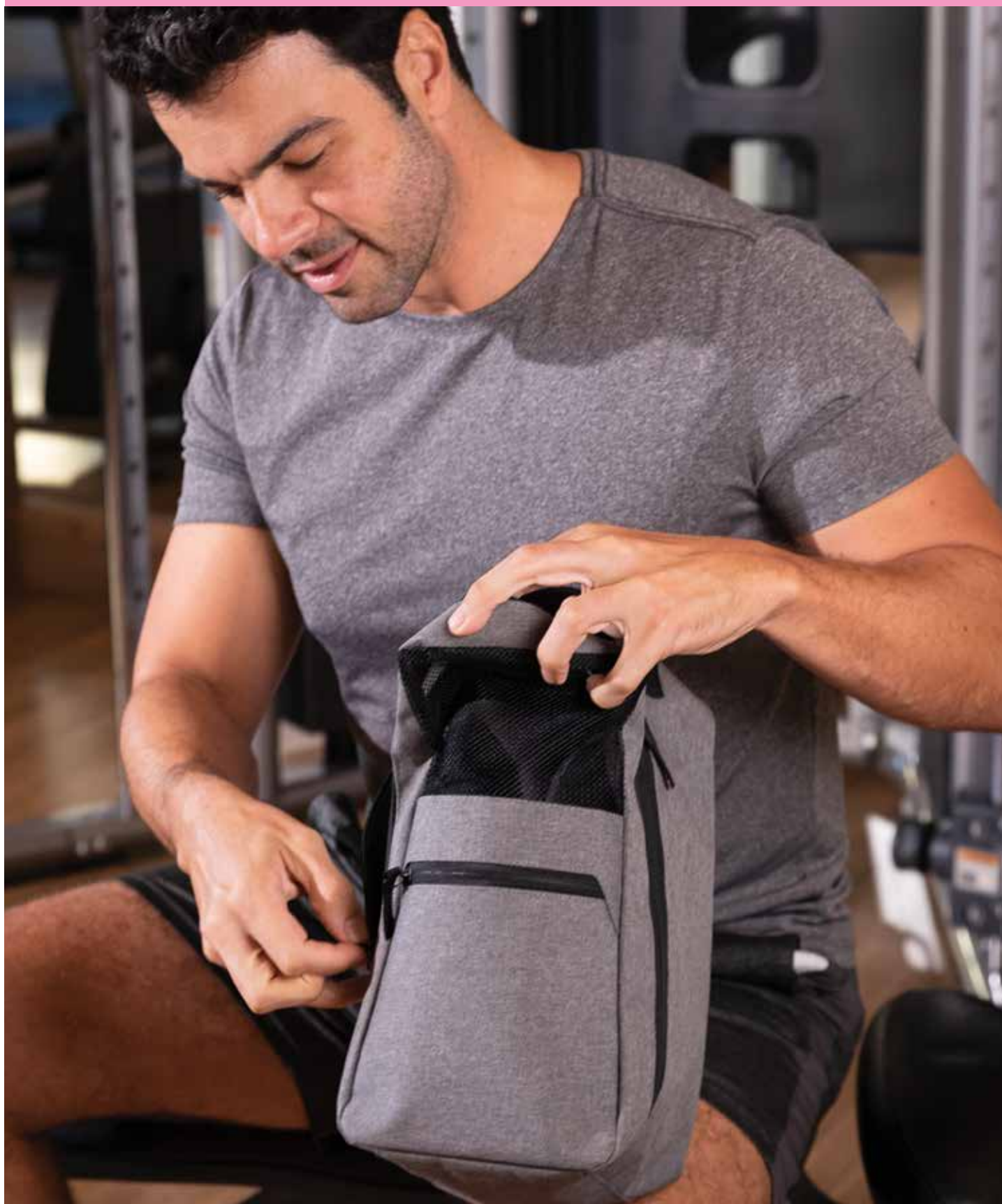



PT1050

Porta tênis em poliéster

Dimensões: 31x17x15cm

Peso unit.: 0,170kg

NECESSAIRES



NE150

Necessaire em Tyvek® e papel kraft com alça na lateral

Dimensões: 23x12x10cm

Peso unit.: 0,066kg

Tyvek® é um material 100% sintético feito de fibras de polietileno trançado de alta densidade. Leve, durável e respirável, porém resistente a água, abrasão, penetração bacteriana e o tempo.



NE200

Necessaire em couro sintético

Dimensões: 21,4x12,7x9,8cm

Peso unit.: 0,116kg



NE202

Necessaire em couro sintético

Dimensões: 20,4x13,5x5,0cm
Peso unit.: 0,063kg



NE201

Necessaire em couro sintético e nylon

Dimensões: 22,9x13,7x9,5cm
Peso unit.: 0,135kg

NECESSAIRES



NE090

Necessaire cursor duplo em poliéster

Dimensões: 27x18x15 cm

Peso unit.: 0,150kg



NE100

Necessaire cursor duplo em poliéster

Dimensões: 27x18x15 cm

Peso unit.: 0,150kg



NE101

Necessaire poliéster e couro sintético

Dimensões: 18x25x11cm

Peso unit.: 0,164kg



NERU613

Necessaire em poliéster com bolso na frente e no verso com divisórias interna

Dimensões: 20x24x10cm

Peso unit.: 0,226kg

BOLSA TÉRMICA





BT306

Mochila térmica em poliéster 14 litros

Dimensões: 42x24,6x14,5cm

Peso unit.: 0,286kg

BOLSA TÉRMICA



BT300

Bolsa térmica em poliéster 25 litros

Dimensões: 39x26x26cm

Peso unit.: 0,510kg



BT305

Bolsa térmica em poliéster 25 litros

Dimensões: 39x26x26cm

Peso unit.: 0,510kg



BT303

Bolsa térmica em poliéster 16 litros

Dimensões: 33x32x16cm

Peso unit.: 0,450kg



BT301

Bolsa térmica em poliéster 12 litros

Dimensões: 21x26x21cm

Peso unit.: 0,360kg



BOLSA TÉRMICA



BT304

Bolsa térmica em poliéster 10 litros

Dimensões: 25x20x35 cm

Peso unit.: 0,350kg



BT302

Bolsa térmica com banqueta 10 litros

Dimensões: 42,5x29x35cm

Peso unit.: 1,500kg



BT307

Bolsa térmica em poliéster 4 litros

Dimensões: 22x25x14cm

Peso unit.: 0,180kg



BT308

Bolsa térmica conservadora em nylon 6,5 litros

Dimensões: 44,5x13,0x30,0cm

Peso unit.: 0,267 kg





PA110

Pasta executiva p/ notebook

Dimensões: 40x29x5cm

Peso unit.: 0,380kg



PA120

Pasta para notebook em poliéster

Dimensões: 40x26,5x2cm

Peso unit.: 0,220kg

GARRAFAS





GA6700

Garrafa aço inox parede dupla 450 ml com infusor e visor de temperatura digital na tampa, conserva a temperatura quente ou fria

Dimensões: 22xø6,3cm

Peso unit.: 0,258kg

GARRAFAS





GA6750

Garrafa aço inox parede dupla 450 ml com infusor, conserva a temperatura quente ou fria
Dimensões: 22xø6,3cm
Peso unit.: 0,258kg

GARRAFAS



GA6800

**Garrafa de bambu e aço inox parede dupla
400 ml com infusor, conserva a temperatura
quente ou fria**

Dimensões: 20,5xø8cm

Peso unit.: 0,300kg



GA4700

**Garrafa aço inox parede dupla 500 ml,
conserva a temperatura quente ou fria**

Dimensões: 24xØ7cm

Peso unit.: 0,640kg

GARRAFAS



GA7000

**Garrafa de vidro borossilicato de 600 ml,
tampa de bambu com alça tipo corda,
resistente à temperatura de até 320°C**

Dimensões: 23,7xø6,5cm

Peso unit.: 0,308kg



GA7100

**Garrafa de vidro borossilicato parede dupla
360 ml com infusor, tampa de bambu com alça
tipo corda, conserva a temperatura quente
e frio, até 320°C**

Dimensões: 22,4xø6,4cm

Peso unit.: 0,446kg

GARRAFAS





GA6100

**Garrafa aço inox parede dupla 500 ml,
conserva a temperatura quente ou fria**

Dimensões: 22xØ7,2cm

Peso unit.: 0,285kg

GARRAFAS



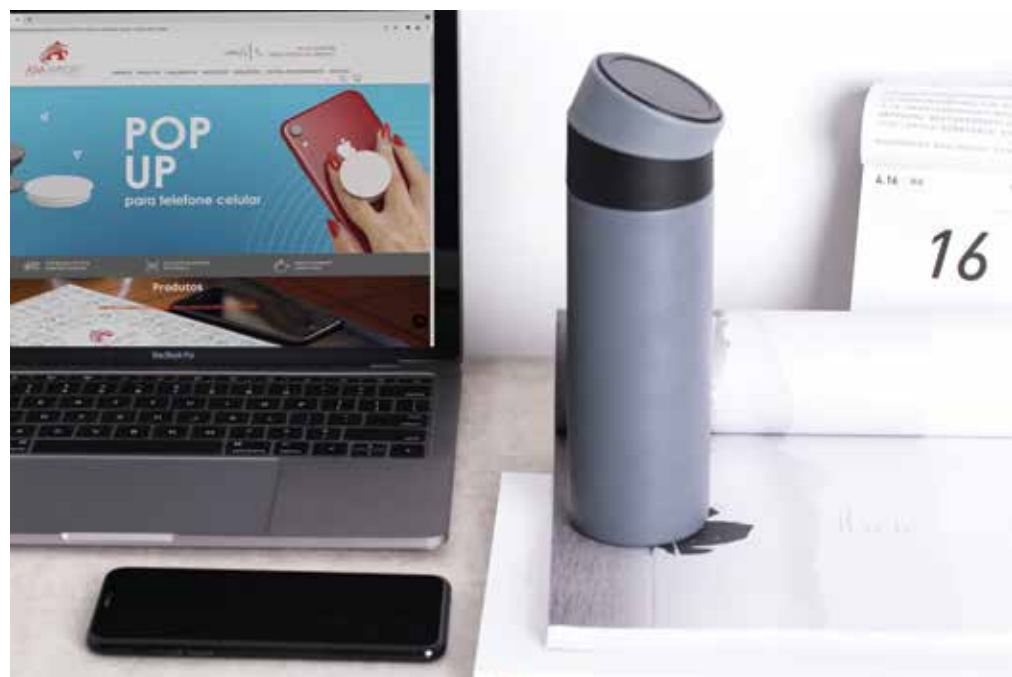

GA7300

Garrafa aço inox parede dupla 400 ml com apoio para celular na tampa, conserva a temperatura quente ou fria

Dimensões: 21xø6,5cm

Peso unit.: 0,255kg

GARRAFAS



GA7450

Garrafa aço inox parede dupla de 500 ml com suporte para celular na tampa, conserva a temperatura quente ou fria

Dimensões: 20,5xø7cm

Peso unit.: 0,265kg



GA7400

Garrafa aço inox parede dupla 500 ml com suporte para celular na tampa, conserva a temperatura quente ou fria

Dimensões: 20,5xø7cm

Peso unit.: 0,265kg

GARRAFAS



GA7200

**Garrafa aço inox parede dupla 500 ml,
conserva a temperatura quente ou fria**
Dimensões: 25xø7cm
Peso unit.: 0,337kg



GA2955

**Garrafa aço inox parede dupla 750 ml,
conserva a temperatura quente ou fria**

Dimensões: 26,5xØ8,4cm

Peso unit.: 0,400kg

GARRAFAS



GA4600M

Garrafa aço inoxidável 750 ml

Dimensões: 27xØ7,4cm

Peso unit.: 0,185kg



GA6300

Garrafa aço inoxidável 750 ml

Dimensões: 26xØ8cm

Peso unit.: 0,280kg



GA4600

Garrafa aço inoxidável 750 ml

Dimensões: 27xø7,4cm

Peso unit.: 0,185kg

GARRAFAS



GA5500

Garrafa aço inoxidável 700 ml
Dimensões: 27cmXØ7,4cm
Peso unit.: 0,260kg



GA0132

Garrafa aço inox 750 ml com mosquetão

Dimensões: 23,0xø7,0cm

Peso unit.: 0,223kg



GA5100

Garrafa de alumínio de 600ml

Dimensões 20xø7,5cm

Peso unit.: 0,160kg

GARRAFAS

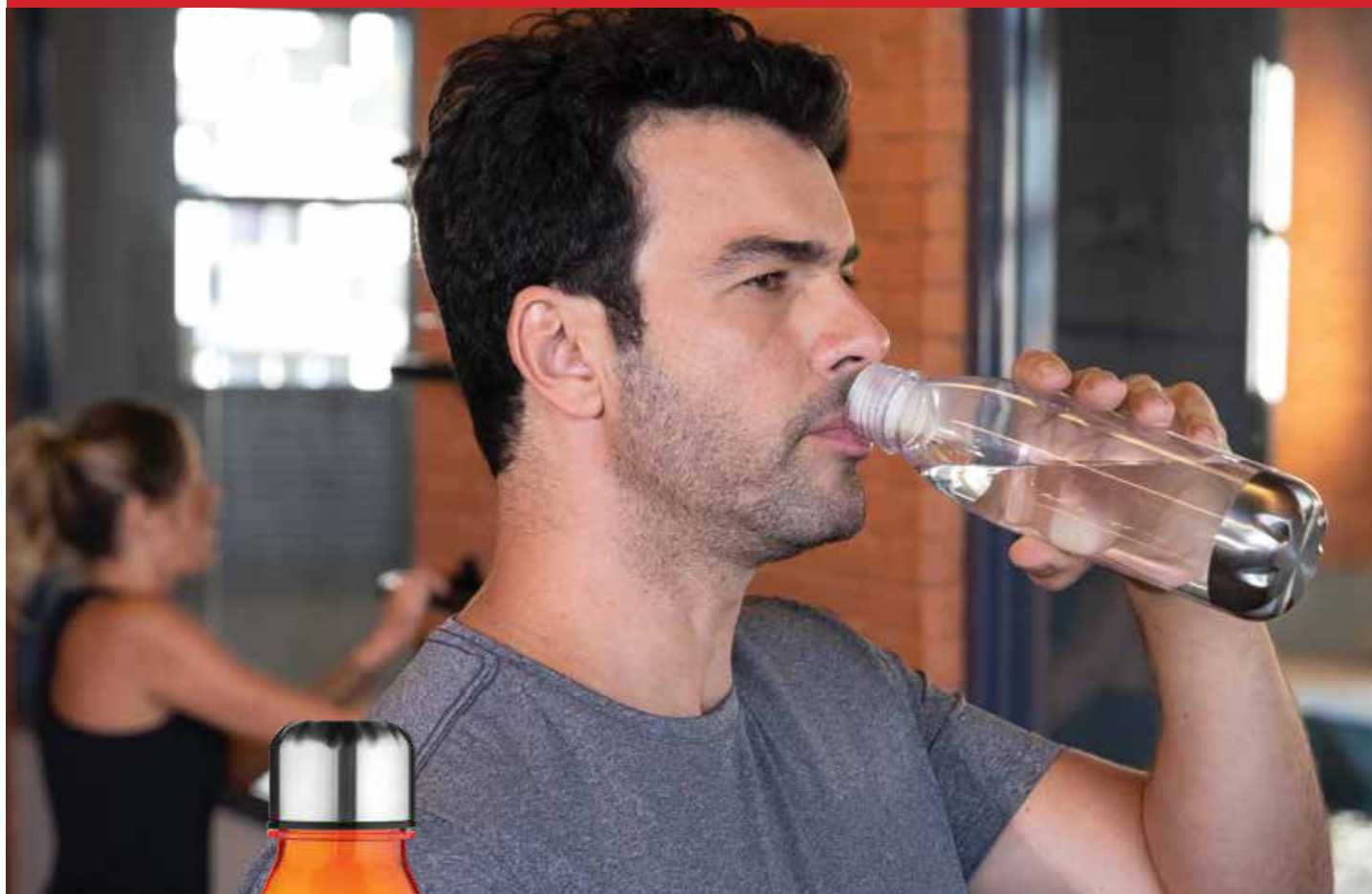

GA4500

Garrafa plástica 700 ml

Dimensões: 25xø7,4cm

Peso unit.: 0,096kg



ECO 



GA7500

Garrafa RPET* 500ml com alça e tampa de metal

Dimensões: 19,7xø6,5cm

Peso unit.: 0,092kg

*RPET: Tereftalato de polietileno reciclado

GARRAFAS



GA2000

Garrafa plástica 750 ml com infusor

Dimensões: 25,0xø7,0cm

Peso unit.: 0,160kg



GA3000

Garrafa plástica 700 ml

Dimensões: 23xø7cm

Peso unit.: 0,120kg



GA5300

**Garrafa plástica 700 ml
com porta gelo e canudo**

Dimensões: 26xø7,50cm

Peso unit.: 0,100kg



GA5700

Garrafa em silicone retrátil 500 ml

Dimensões: expandida 22,5xø7cm /
retraída 12,5xø7cm

Peso unit.: 0,210kg

GARRAFAS



GA4100

Garrafa plástica 600 ml com porta pílulas

Dimensões: 23,0xø7,5cm

Peso unit.: 0,130kg



GA3100

Garrafa plástica 700 ml

Dimensões: 27,5xø7cm

Peso unit.: 0,286kg



GA4000

Garrafa plástica 600 ml

Dimensões: 23,0xø7,0cm

Peso unit.: 0,138kg

GARRAFAS



GA6025

Garrafa plástica 600 ml com infusor

Dimensões: 25,0xø6,4x21cm

Peso unit.: 0,120kg



GA5000

Garrafa coqueteleira 720 ml

Dimensões: 24,4xø10,2cm
Peso unit.: 0,250kg



GA5800

Garrafa plástica 1500 ml

Dimensões: 26xø10cm
Peso unit.: 0,200 kg



GA5900

Garrafa plástica 1500 ml com bico rosqueável

Dimensões: 31xø10cm
Peso unit.: 0,240 kg



CA9000

**Caneca aço inox parede dupla
450 ml, conserva a temperatura
quente ou fria**

Dimensões: 21xø7,3cm

Peso unit.: 0,290kg



CA8300

**Caneca aço inox parede dupla 450 ml,
conserva a temperatura quente ou fria**

Dimensões: 21xø7,3cm

Peso unit.: 0,290kg

COPOS E CANECAS



CA9100

Caneca aço inox 450 ml com tampa plástica

Dimensões: 16,3x 7cm

Peso unit.: 0,176kg



CA8400

Caneca inox parede dupla 350 ml, conserva a temperatura quente ou fria

Dimensões: 14,1x9cm

Peso unit.: 0,225kg



CA8200

Caneca em aço inox 350ml, alça de mão plástica tipo mosquetão e tampa com vedação

Dimensões: 12,3x8cm

Peso unit.: 0,240kg



CA8100

**Caneca aço inox parede dupla antiqueda 260 ml,
conserva a temperatura quente ou fria**

Dimensões: 13ø8,5cm

Peso unit.: 0,270kg



CA0150

Caneca plástica e aço inox 400 ml

Dimensões: 12,5xø9,0cm

Peso unit.: 0,254kg



CA0150T

**Caneca plástica 400 ml
com inox na parte interna**

Dimensões: 12,5xø9cm

Peso unit.: 0,254kg



CA0160

**Caneca plástica 300 ml
com inox na parte interna**

Dimensões: 11x9cm

Peso unit.: 0,140kg

COPOS E CANECAS



C08200

Copo plástico antiqueda 500 ml

Dimensões: 22xø8,5cm

Peso unit.: 0,290kg



C08500

Copo de silicone retrátil 500 ml

Dimensões: Expandido 18xø8,5cm

Dimensões: Retraído 7,3xø8,5cm

Peso unit.: 0,180kg



C08350

Copo de silicone retrátil 350 ml

Dimensões: Expandido 14,3xø8,5cm

Dimensões: Retraído 6,2xø8,5cm

Peso unit.: 0,125kg

COPOS E CANECAS



C08900

Copo plástico e fibra de arroz 550 ml

Dimensões: 16x9øcm

Peso unit.: 0,086kg



C08950

Copo plástico e fibra de arroz 350 ml

Dimensões: 11x9øcm

Peso unit.: 0,060kg



C0019

Copo plástico e fibra de bambu 450 ml

Dimensões: 14xø8cm

Peso unit.: 0,100kg



C0020

Copo plástico e fibra de bambu 450 ml

Dimensões: 14xø8cm

Peso unit.: 0,100kg



C06021

Copo plástico com canudo 470ml

Dimensões: 18,5x10cm

Peso unit.: 0,200kg



C08100

**Copo de plástico 500 ml
com esmecedor de frutas**

Dimensões: 23x7cm

Peso unit.: 0,120kg



C08600

Copo plástico 600ml com tampa e canudo

Dimensões: Ø10cm, 19,5cm altura

Peso unit.: 0,110kg



C08700

Copo plástico 550ml com glitter

Dimensões: Ø10x16cm

Peso unit.: 0,155kg

COPOS E CANECAS



C08800

Copo plástico 600ml com tampa e canudo

Dimensões: Ø10x16cm

Peso unit.: 0,095Kg



C017266

Copo plástico 800 ml para salada com recipiente para molho e garfo

Dimensões: 19xØ13cm

Peso unit.: 0,076kg



C07000

Copo plástico parede dupla 400 ml

Dimensões: 14,5xø9cm

Peso unit.: 0,146kg



CN002

Kit canudo reto, curvo e escova 3 peças

Dimensões: 21,5x0,6cm

Peso unit.: 0,040kg



GT8924

Kit canudo de silicone e escova 2 peças

Dimensões: 20xø1cm

Peso unit.: 0,025 kg



CJ40024

Kit escritório antibacteriano, contendo:
1 Bloco de anotações capa material PP;
1 Caneta plástica retrátil;
1 Copo plástico 350ml com tampa.

Dimensões: 15x12x10cm

Peso unit.: 0,218kg



ANTI
BACTERIANO



BL028

**Kit Escritório antibacteriano, contendo:
1 Bloco de anotações capa em material PP
com suporte para canetas;
1 Caneta plástica retrátil.**

Dimensão: 14x9x0,7cm

Peso unit.: 0,067kg

ESCRITÓRIO



ANTI
BACTERIANO



CJ40025

Kit escritório antibacteriano, contendo:

1 Caneta plástica retrátil;

1 Lapiseira plástica retrátil;

1 Régua plástica 15cm;

1 Borracha.

Dimensões: 16,5x3cm

Peso unit.: 0,050kg



**ANTI
BACTERIANO**



CAD360

**Kit Escritório antibacteriano, contendo:
1 Caderno de anotações capa material PP
com suporte para canetas;**

1 Caneta plástica retrátil

Dimensões: 21x14,5x0,7cm

Peso unit.: 0,160kg



CAD370

Kit escritório, contendo:

1 Caderno de anotações com capa material PP e café e suporte para caneta;

1 Caneta material plástico e café.

PRODUTOS COM AROMA DE CAFÉ.

Dimensões: 21x14,5x0,7cm

Peso unit.: 0,190kg



BL029

**Kit escritório, contendo:
1 Bloco de anotações capa material PP
e café com suporte para canetas;
1 Caneta material plástico e café.
PRODUTOS COM AROMA DE CAFÉ.**

Dimensão: 14x9x0,7cm

Peso unit.: 0,065kg



CAD007

Caderno de anotações capa de bambu com elástico

Dimensões: 20,5x13,1cm

Peso unit.: 0,265kg



CAD380

**Kit escritório, contendo:
Caderno de anotações capa bambu
com elástico e suporte para caneta;
Caneta de Bambu esferográfica
com detalhes em plástico**

Dimensões: 14x9x1,9 cm
Dimensão caneta: 14x1,1cm
Peso unit.: 0,100kg



CAD390

**Kit escritório, contendo:
Caderno de anotações capa bambu
com elástico e suporte para caneta;
Caneta de Bambu esferográfica com
detalhes em metal;**

Dimensões: 18x13,5x1,9cm
Dimensão caneta: 13,5x1,1cm
Peso unit.: 0,180kg



BL031

Bloco de anotações formato de cubo em papelão reciclado, contendo:
5 blocos autocolantes coloridos com 100 folhas;
5 blocos autocolantes coloridos com 20 folhas;
Porta canetas;
Sticky notes.

Dimensões: 9,5x9,5x9,5cm
Peso unit.: 0,306kg



BL032

Bloco de anotações em papelão reciclado, contendo:

5 blocos autocolantes coloridos com 25 folhas;

1 bloco de adesivo amarelo com 25 folhas;

Porta canetas;

Porta Retrato.

Dimensões: 13,5x9,5x4,0cm

Peso unit.: 0,094kg

ESCRITÓRIO





CJ11453

Kit Escritório, contendo:

1 Bloco de anotações em formato de nuvem em material plástico e fibra de trigo;

1 Porta clips;

1 Caneta plástica com fibra de trigo

Dimensões: 10x6,5x3,2cm

Peso unit.: 0,076kg

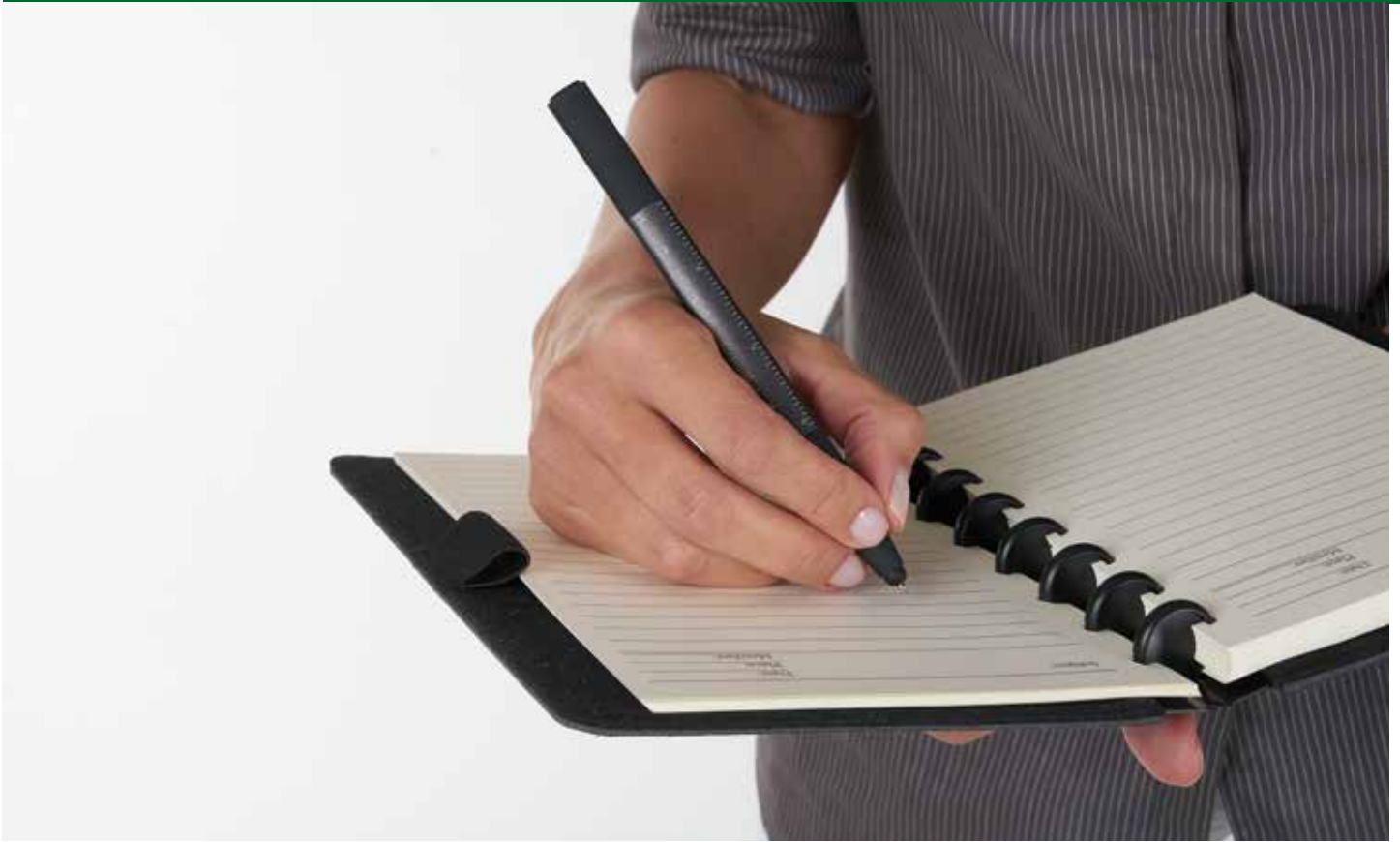



CAD350

**Caderno de anotações capa dura
com folhas destacáveis**

Dimensões: 22,3x18x2,1 cm

Peso unit.: 0,420kg



CAD400

Caderno de anotações em couro reciclado com porta canetas

Dimensões: 21,0×14,5×1,4cm

Peso unit.: 0,210kg



CJ40035

Kit escritório, contendo:
Bloco de anotações
com 40 folhas pautadas bege;
5 Blocos adesivos colorido
com 25 folhas cada;
Bloco de anotações adesivo
7,5cm x 7,5cm amarelo com 25 folhas;
1 Porta Cartão;
1 Régua de 15cm em bambu;
1 Apontador de lápis em bambu;
1 Borracha;
1 Caneta de papelão
com detalhes em plástico;
2 Lápis de bambu.
Dimensões: 21x15cm
Peso unit.: 0,319kg



BL030

Bloco de anotações com 200 folhas brancas e 5 blocos autocolantes colorido

Dimensões: 8,1x8,3x2,6cm
Peso unit.: 0,108kg



BL026

Bloco de anotações com sticky notes

Dimensões: 8,0x5,3x1,2cm
Peso unit.:0,025kg



BL024

Bloco de anotações com sticky notes

Dimensões: 13,5x11,5x1,2cm

Peso unit.: 0,145kg



BL025

Bloco de anotações com sticky notes

Dimensões: 10,5x8,0x1,2cm

Peso unit.: 0,060 kg

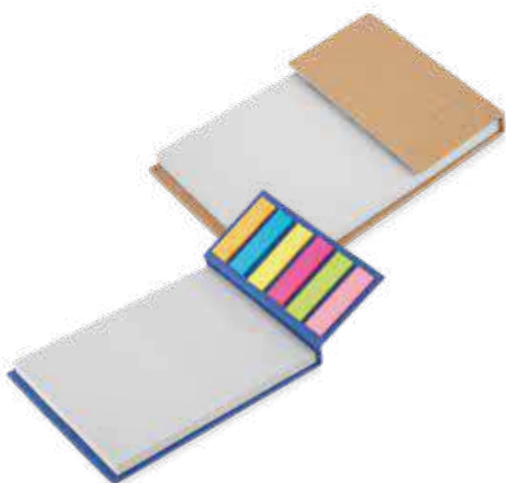

BL022

Bloco de anotações com sticky notes

Dimensões: 16x10x2cm

Peso unit.:0,115kg

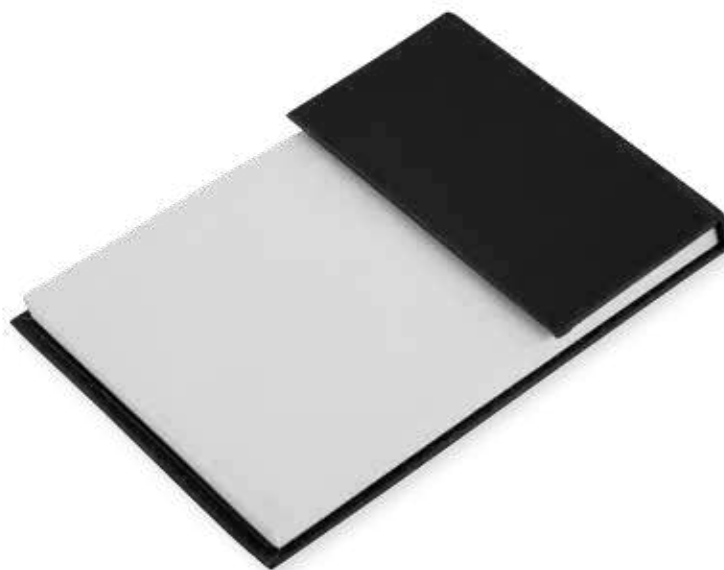

BL023

Bloco de anotações com sticky notes

Dimensões: 14,4x9,4x1,0cm

Peso unit.: 0,088kg

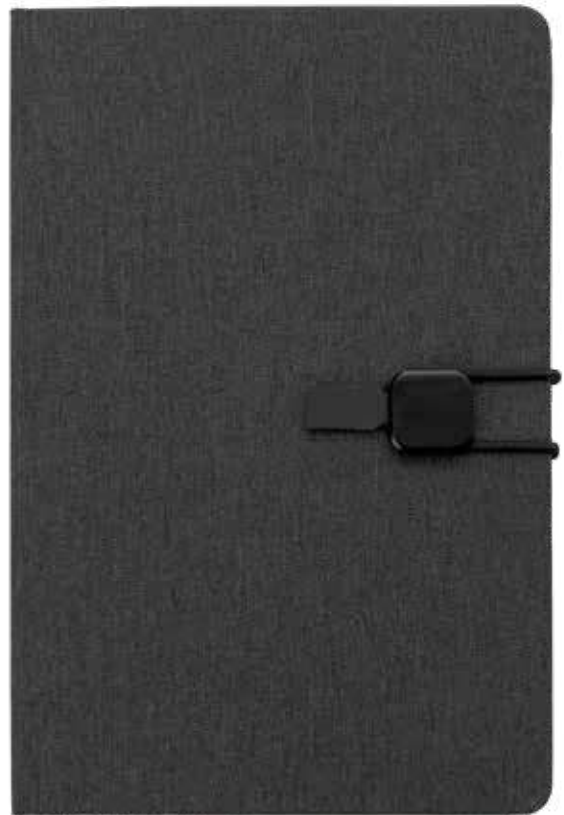

CAD340

Caderno de anotações com elástico e porta canetas

Dimensão: 21,4x14,5x1,5cm

Peso unit.: 0,294kg



CAD100

Caderno de anotações com sticky notes

Dimensões: 21x15x1,5cm

Peso unit.: 0,270kg



CAD330

Caderno capa dura 96 folhas wire-o

Dimensões: 24x18x1,5cm

Peso unit.: 0,445 kg



CAD110

Caderno de anotações com porta objetos

Dimensões: 21,5x15,5x1,5cm

Peso unit.: 0,295kg



CAD120

Caderno de anotações com elástico suporte para celular e caneta

Dimensões: 21x14x1,5cm

Peso unit.: 0,282kg



CAD005

**Kit escritório, contendo:
Caderno de anotações com elástico
e porta canetas com 30 folhas;
Caneta de papel reciclado esferográfica com
detalhes em plástico.**

Dimensões: 21x14x0,4cm
Dimensão caneta: 14x0,95cm
Peso unit.: 0,080kg



CAD003

Caderno de anotações com elástico e porta canetas

Dimensões: 14x9x2cm
Peso unit.: 0,115kg



CAD004

Caderno de anotações com elástico e porta canetas

Dimensões: 21x14x2cm
Peso unit.: 0,230 kg



CAD006

Caderno de anotações com sticky notes e régua destacável

Dimensões: 21x14x0,8cm

Peso unit.: 0,214kg



CAD230

Caderno com powerbank

Dimensões: 23x17x3cm

Peso unit.: 0,610 kg



CAD270

Caderno de anotações com suporte porta caneta

Dimensões: 21,3x14,3x1,5cm
Peso unit.: 0,300kg



CAD280

Caderno de anotações com suporte p/ caneta e porta cartão

Dimensões: 21x14x1,5cm
Peso unit.: 0,300kg

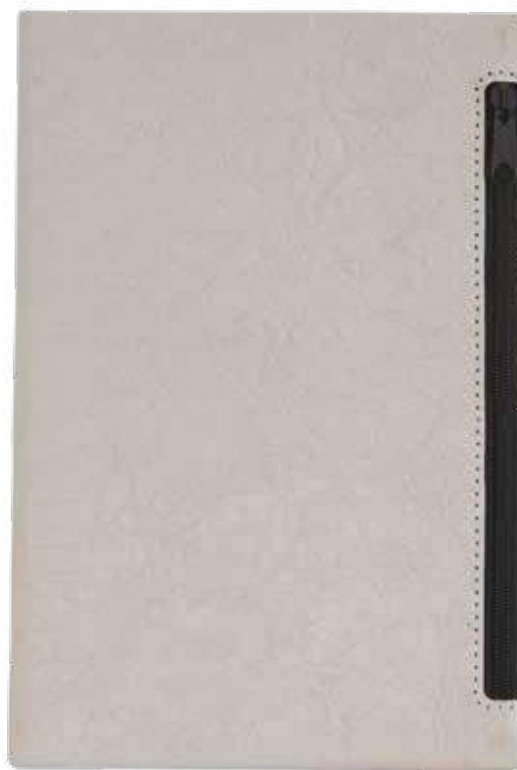

CAD260

Caderno de anotações com porta objetos

Dimensões: 21,3x14,3x1,5cm

Peso unit.: 0,300kg



PC600

Pasta executiva com bloco de anotações

Dimensões: 31x24x1,8m

Peso unit.: 0,476kg



PC700

Pasta executiva com bloco de anotações

Dimensões: 31x23,5x2cm

Peso unit.: 0,450kg



PC900

Pasta executiva com bloco de anotações

Dimensões: 31x23,8x2cm

Peso unit.: 0,480 kg



SVT003

Suporte para celular com porta canetas e clips

Dimensões: 12,4x12,4x3,5cm

Peso unit.: 0,085kg



PW001

Protetor de webcam 1,8X0,9cm

Dimensões: 1,8x0,9cm

Peso unit.: 0,002kg



PW002

Protetor de webcam 3x1,2cm

Dimensões: 3x1,2cm

Peso unit.: 0,006 kg

ESCRITÓRIO



MP350

Mouse Pad em material sintético grafite e bambu, contendo:
porta canetas; porta Cartões; porta celular
Dimensões: 25x25,4x1,5cm
Peso unit.: 0,280kg



SVT007

Organizador de cabos tipo carretel
Dimensões: 6,5xØ 2,1cm
Peso unit.: 0,013kg



SVT005

Organizador de cabos emborrachado
Dimensões: 1,4xØ3,1cm
Peso unit.: 0,006kg



SVT006

Organizador flexível de cabos

Dimensões: 3xØ7cm

Peso unit.: 0,010kg

CANETAS SUSTENTÁVEIS



CB47012

**Caneta de Bambu esferográfica com
detalhes em plástico e metal.**

Acompanha estojo de papel

Dimensões: 17,4x5,4x2,3cm

Peso unit.: 0,035kg



CM0118

Caneta metal esferográfica detalhe em bambu com estojo

Dimensões: 14,0xØ1,2cm

Peso unit.: 0,023kg

CANETAS SUSTENTÁVEIS



CB22941

**Caneta Bambu esferográfica
com detalhes em metal
Acompanha estojo de papel**

Dimensões: 13,9x1,05cm
Peso unit.: 0,0086kg



CB10884-BG

**Caneta de Bambu esferográfica
com detalhes em plástico
Acompanha estojo de papel**

Dimensões: 14x1,1cm
Peso unit.: 0,009kg



CB12948

**Caneta de Bambu esferográfica
com detalhes em metal
Acompanha estojo de papel**

Dimensões: 14x1,3cm
Peso unit.: 0,0095kg



CB13516

**Caneta de Bambu esferográfica
com detalhes em plástico e metal
Acompanha estojo de papel**

Dimensões: 14x1,1cm
Peso unit.: 0,009kg

CANETAS SUSTENTÁVEIS



CP0107C

**Caneta de papel reciclado colorido
esferográfica com detalhes em plástico PLA
biodegradável**

Dimensões: 14x1,05cm
Peso unit.: 0,0075kg



CP0107D

Caneta de papel reciclado esfográfica com detalhes em plástico PLA biodegradável

Dimensões: 14x1,05cm

Peso unit.: 0,0075kg



CPYFA2649B

Caneta corpo em cortiça com detalhes em plástico

Dimensões: 14xØ1,1cm

Peso unit.: 0,008kg

CANETAS PLÁSTICAS



CP2000B

Caneta plástica esferográfica retrátil

Dimensões: 14xø0,96 cm
Peso unit.: 0,006 kg



CP2000

Caneta plástica esferográfica retrátil

Dimensões: 14xø0,96cm
Peso unit.: 0,006kg



CP3000B

Caneta plástica esferográfica retrátil

Dimensões: 13,9xø0,96cm

Peso unit.: 0,007kg



CP3000

Caneta plástica esferográfica retrátil

Dimensões: 13,9xø0,96cm

Peso unit.: 0,007kg

CANETAS PLÁSTICAS



CP8202

Caneta plástica esferográfica retrátil com ponta touch, apoio e limpa tela para celular

Dimensões: 14,7x1,1cm
Peso unit.: 0,09 kg



CP0302

Caneta plástica esferográfica retrátil

Dimensões: 14,6xø1,1cm
Peso unit.: 0,010kg



CP0301

Caneta plástica esferográfica retrátil

Dimensões: 13,5xø0,96cm

Peso unit.: 0,007kg



CS1111

Caneta semimetal esferográfica

Dimensões: 14,4xø1,0cm

Peso unit.: 0,009kg



CP0300B

Caneta plástica esferográfica retrátil

Dimensões: 13,6xø0,97cm

Peso unit.: 0,008kg

CANETAS SEMI-METAL





CS5047

**Caneta plástica esferográfica retrátil
com apoio para celular**

Dimensões: 15,5xØ1,2 cm
Peso unit.: 0,009 kg



CS5062

Caneta plástica esferográfica retrátil

Dimensões: 14,2xØ1,12cm
Peso unit.: 0,009kg

CANETAS SEMI-METAL

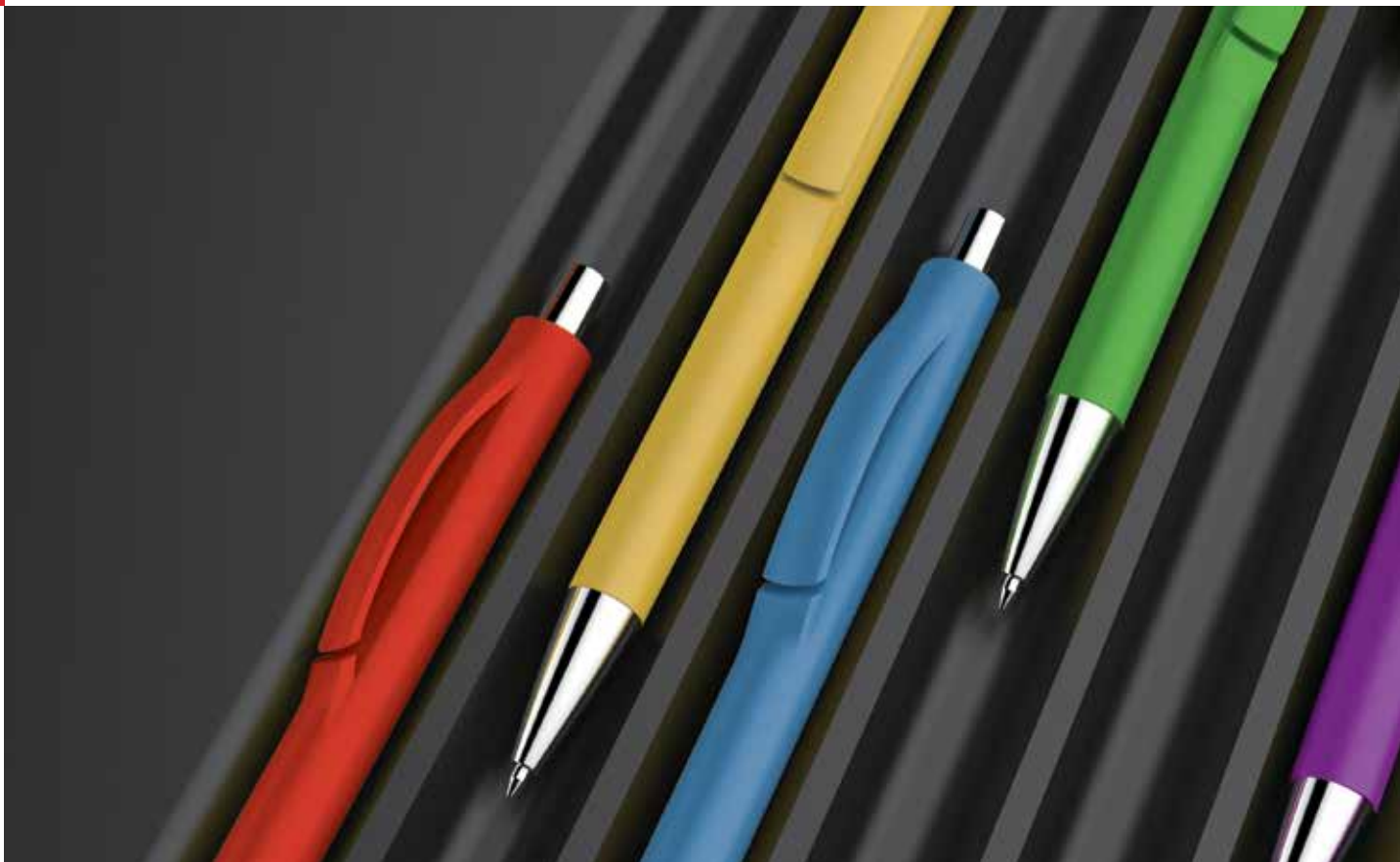

CS5030

Caneta plástica esferográfica retrátil

Dimensões: 15xø1,2cm

Peso unit.: 0,009 kg



CS5036

Caneta semimetal esferográfica retrátil

Dimensões: 13,7xØ1,1cm
Peso unit.: 0,009 kg



CS5082

Caneta plástica esferográfica retrátil

Dimensões: 14,8xØ1,2 cm
Peso unit.: 0,011 kg

CANETAS SEMI-METAL



CS1055

Caneta plástica esferográfica twist

Dimensões: 14,5xØ1,2 cm

Peso unit.: 0,009 kg



CS1056

Caneta semimetal esferográfica retrátil

Dimensões: 14,7x1,1cm

Peso unit.: 0,010kg



CS1033

Caneta plástica esferográfica retrátil

Dimensões: 14,9xø1,1cm
Peso unit.: 0,008 kg



CS1035

Caneta plástica esferográfica retrátil

Dimensões: 14,3xø1,3cm
Peso unit.: 0,009kg

CANETAS METÁLICA



CM0118

Caneta metal esferográfica detalhe em bambu com estojo

Dimensões: 14,0xø1,2cm

Peso unit.: 0,023kg



CM0107A

Caneta metal esferográfica retrátil ponta touch

Dimensões: 14,0xø1 cm
Peso unit.: 0,019 kg



CM0107C

Caneta metal esferográfica retrátil emborrachada ponta touch

Dimensões: 14xø1cm
Peso unit.: 0,019kg

CANETAS METÁLICA



CM2620

Caneta metal esferográfica retrátil ponta touch

Dimensões: 14,0xø1,3cm

Peso unit.: 0,015 kg



CM1096

Caneta metal esferográfica retrátil ponta touch

Dimensões: 14xø1cm

Peso unit.: 0,015kg



CM2640

Caneta metal com ferramentas e ponta touch

Dimensões: 16,0xø1,3cm

Peso unit.: 0,015 kg



CM1809C

Caneta metal esferográfica retrátil LED

Dimensões: 15xø1,15cm

Peso unit.: 0,013kg

CANETAS METÁLICA



CM0108

Caneta metal esferográfica retrátil

Dimensões: 14,0xø1 cm

Peso unit.: 0,016 kg



CM17725R

**Caneta metal esferográfica emborrachada
ponta touch**

Dimensões: 13,5xø0,8cm

Peso unit.: 0,011kg



CM1107S

**Caneta metal esferográfica retrátil
pintura áspera**

Dimensões: 14,0xø0,9cm
Peso unit.: 0,018 kg



CM1067

Caneta metal esferográfica retrátil

Dimensões: 14,5xø1,3cm
Peso unit.: 0,018kg

CANETAS METÁLICA



CM1110C

Caneta esferográfica em metal escrita azul

Dimensões: 14,0xø1cm

Peso unit.: 0,022 kg



CM1072

Caneta metal esferográfica retrátil

Dimensões: 14,5xø1,3cm

Peso unit.: 0,018kg



CM1064A

Caneta metal esferográfica retrátil

Dimensões: 14,6xø1,4cm

Peso unit.: 0,022 kg



CM1103D

Caneta metal esferográfica retrátil

Dimensões: 14,2xø1,1cm

Peso unit.: 0,020kg

CANETAS METÁLICA



CM2630

Caneta metal esferográfica

Dimensões: 14,0xø1,3cm

Peso unit.: 0,033 kg



CM2630R

Caneta metal roller

Dimensões: 14,0xø1,3cm

Peso unit.: 0,033kg



CM0300

Caneta metal esferográfica

Dimensões: 13,6xø1,1cm

Peso unit.: 0,029 kg



CM0300R

Caneta metal roller

Dimensões: 13,8xø1,1cm

Peso unit.: 0,029kg

CANETAS METÁLICA

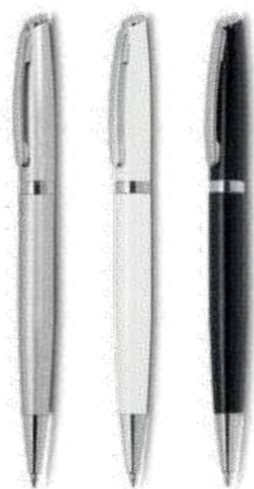

CM1027S

Caneta metal esferográfica

Dimensões: 14,0xø1,3cm

Peso unit.: 0,023 kg



CM1027SR

Caneta metal roller

Dimensões: 14xø1,3cm

Peso unit.: 0,023kg



CM1027G

Caneta metal esferográfica

Dimensões: 14,5xø1,1cm
Peso unit.: 0,020 kg



CM1027GR

Caneta metal roller

Dimensões: 14xø1,1cm
Peso unit.: 0,020kg

CANETAS METÁLICA



CM1101A

Caneta metal esferográfica

Dimensões: 14,0xø1,7cm

Peso unit.: 0,022 kg



CM1101B

Caneta metal esferográfica

Dimensões: 14xø1,7cm

Peso unit.: 0,023kg



CM1101R

Caneta metal roller
Dimensões: 14,0xø1,7cm
Peso unit.: 0,023 kg



CM1640

Caneta metal esferográfica com estojo
Dimensões: 14xø1,7cm
Peso unit.: 0,048kg



EM1640

Estojo de papelão para 1 caneta

Dimensões: 17x4x2,5cm

Peso unit.: 0,018 kg



EM0114

Estojo de papelão bambu print

Dimensões: 17,4x5,4x2,3cm

Peso unit.: 0,018kg



EM0147

Estojo executivo para até 2 canetas

Dimensões: 19x7x2,5cm

Peso unit.: 0,085kg



EM0134

Estojo de metal para 2 canetas

Dimensões: 17,8x6,0x2,0cm

Peso unit.: 0,062kg



EM0135

Estojo de metal para 1 caneta

Dimensões: 17,8x3,8x2,0cm

Peso unit.: 0,055kg

CHAVEIROS





CH53074

Chaveiro de metal com detalhe em bambu

Dimensões: 8x5cm

Peso unit.: 0,0268kg

CHAVEIROS



CH77010A

Chaveiro de plástico e material antibacteriano, com as funções:
Ponta Touch;
Abridor de Garrafas;
Acionador de superfícies sem o contato físico;
Dimensões: 10,3x0,6cm
Peso unit.: 0,0235kg



CH77010B

Chaveiro de plástico e material antibacteriano, com as funções:

Ponta Touch;

Abridor de Garrafas;

Aciona superfícies sem o contato físico;

Dimensões: 10,3x0,6cm

Peso unit.: 0,0235kg

CHAVEIROS



CH0508

Chaveiro de metal e nylon

Dimensões: 8,5x3,4cm
Peso unit.: 0,032kg



CH0685

Chaveiro de metal e couro sintético

Dimensões: 10,5x3,2cm
Peso unit.: 0,044kg



CH0211

Chaveiro de metal e couro sintético

Dimensões: 9,0x2,5cm
Peso unit.: 0,044kg



CH6898

Chaveiro de metal e couro sintético

Dimensões: 10,5x1,8cm

Peso unit.:0,034kg



CH0510

Chaveiro de metal e couro sintético

Dimensões: 12,8x3,5cm

Peso unit.: 0,054kg





LF0200

Lanterna led com Kit Ferramentas de 15 peças

Dimensões: 23, xØ9,5 cm

Peso unit.: 0,586kg

KIT CHURRASCO





KC0125

Kit Churrasco com 4 peças

Dimensões: 35x20x13cm

Peso unit.: 0,550kg



KC0124

Kit churrasco 2 peças estojo em nylon

Dimensões: 33,5x9x2,5cm

Peso unit.: 0,271kg

KIT CHURRASCO



KC0200

Kit Churrasco com 3 peças

Dimensões: 32x20x1,5cm

Peso unit.: 0,760kg



KC0201

Kit Churrasco com 4 peças

Dimensões: 37x22,4x1,5cm

Peso unit.: 1,200kg



TB0200

Tábua para Churrasco

Dimensões: 32x20x1,2cm

Peso unit.: 0,537kg



TB0201

Tábua para Churrasco

Dimensões: 37x22,5x1,2cm

Peso unit.: 0,700kg

KIT CHURRASCO



KC0204

Kit Churrasco com 5 peças

Dimensões: 37x22,5x1,2cm

Peso unit.: 0,650kg





KC0205

Kit Churrasco com 5 peças

Dimensões: 37x22,5x1,2cm

Peso unit.: 0,950kg

KIT QUEIJO



KQ262

**Kit queijo 3 peças, contendo:
Faca, garfo e tábua**

Diâmetro da tábua: 15cm

Dimensões: 27x24x2,3cm

Peso unit.: 0,535kg



KQ269

**Kit queijo 3 peças, contendo:
Faca, garfo e tábua**

Diâmetro da tábua: 14cm
Dimensões: 29,7x22,5x2,5cm
Peso unit.: 0.432kg



KQ270A

**Kit queijo 4 peças, contendo:
Faca, garfo espátula e tábua**

Medidas da tábua: 20,9x13x1cm
Dimensões: 24,2x22,7x2,2cm
Peso unit.: 0,460kg

KIT QUEIJO



KV0130

Kit Vinho de 5 peças em estojo de cortiça

Dimensões: 4,0xø14,5 cm

Peso unit.: 0,308kg



KV0140

Kit vinho 4 peças em estojo plástico modelo garrafa

Dimensões: 23cmxø6,1cm

Peso unit.: 0,224kg



KP0025

Tábua para Pizzas

Dimensões: 1,2xø35cm

Peso unit.: 1,010kg

LANCHEIRAS



LC180

Lancheira com 2 compartimentos talheres e elástico

Dimensões: 10,4x10,3x18,5cm

Peso unit.: 0,395kg



LC190

Lancheira de silicone com 3 compartimentos

Dimensões: 27x11,5x6,5cm

Peso unit.: 0,238kg



LC200

Lancheira de silicone com talheres e molheiro

Dimensões: 18,5x16x0,7cm

Peso unit.: 0,325kg

GUARDA-CHUVA





GC1050

Guarda-chuva invertido cabo plástico haste metal

Comprimento do produto fechado: 82cm

Diâmetro do produto aberto: 110 cm

Peso unit.: 0,620kg

GUARDA-CHUVA



GC1010

Guarda-chuva cabo plástico e haste metal

Dimensão Produto Fechado: 24x4cm

Dimensão do Produto Aberto: 95cm

Peso unit.: 0,200kg



GC1040

Guarda-chuva automático com botão acionador

Dimensão do produto: Fechado: 28,5cm.

Dimensão do produto: A0berto: 95cm

Peso unit.: 0,345kg



GC1000

Guarda-chuva cabo de madeira haste metal

Dimensão Produto Fechado: 53xØ5cm

Dimensão Produto Aberto: 120cm

Peso unit.: 1,000kg



GC1060

Guarda-chuva

Dimensões: 84xØ110cm

Peso unit.: 0,440kg

Presentes
para todos os
Momentos



ANIVERSÁRIOS

Kit para Petisco e Champagne Conta com petisqueira formato de trevo em Bambu; duas taças para champagne em Vidro; espaço para garrafa com palha. Estão perfeitamente acomodados em uma caixa para presentear.



Kit para Petisco. Conta com tábua redonda com sulco e duas espátulas 14cm em Bambu; dois ramekins, um pequeno e um mini em Porcelana. Estão perfeitamente acomodados em uma caixa para presentear.



Jogo com 2 taças de Vidro para Champagne, com espaço para a garrafa grande. Capacidade: 190ml. Utilidade do Produto: Ideal para brindar os melhores momentos



Jogo com 2 Taças de Vidro para Vinho. Capacidade: 490ml. Utilidade do Produto: Ideal para brindar os melhores momentos.



ANIVERSÁRIOS

Jogo com 2 Taças de
Vidro para Gin.
Capacidade: 600ml
cada



Copo de Vidro para
Cerveja/Drinks.
Capacidade: 200ml



Caneca em cerâmica
branca com capacidade
total de 270 ml



Porta-retrato em
alumínio fosco.
Conta com vidro
frontal, apoio em
polipropileno preto
e uma fina espuma
no interior para
acomodar melhor
a foto. Pode ser
usado na vertical ou
horizontal, tanto na
parede quanto na
superfície. Ideal para
fotos 10x15cm com
área útil visível de
9x13cm



ESCRITÓRIO / HOME OFFICE

Caneca em Aço Inox
com revestimento
de Poliestireno
branco e tampa
em Polipropileno.
Capacidade: 400 ml



Caneca em Fibra de
Bambu/PP. Conta
alça para melhor uso.
Capacidade: 350 ml



Caneca em polipropileno preto e revestida em aço inox escovado. Possui tampa rosqueável com trava de abertura e anel interno em silicone para vedação. Capacidade: 410 ml
MATERIAL ATÓXICO
- TESTADO E APROVADO.



Copo em Fibra de Bambu / PP. Conta com tampa e abertura para beber o líquido. Capacidade: 450 ml



Bolsa Térmica preta em Polyester 600D/PEVA - não impermeável. Conta com alça ajustável, bolso frontal e fechamento em zíper. Forro interno cinza feito de PEVA. Tempo de Conservação aproximado: Frio 10 horas / Quente 3 horas.



Bolsa Térmica preta em Polyester 600D, 300D e PEVA. Conta com alças de mão, alça de ombro, bolso frontal com zíper, dois bolsos laterais com zíper, elástico superior trançado. Forro interno branco feito de PEVA, atóxico e mais sustentável que o PVC. Tempo de Conservação aproximado: Frio 10 horas / Quente 3 horas.



Kit para Churrasco e Cerveja. Acompanha tábua com três furos em Bambu; faca 8" e garfo em Bambu/Inox; seis copos de cerveja em Vidro; caixa para truco com marcador de tentos e jogos em MDF; jogo de cartas.



Conjunto para Churrasco / Cerveja / Truco. Acompanha tábua com três furos em Bambu; faca 8" e garfo em Bambu/Inox; quatro copos de cerveja em Vidro; caixa para truco com marcador de tentos e jogos em MDF; jogo de cartas. Como cortesia, na faca 8" fazemos uma gravação com os cortes do boi.



Canivete
confeccionado em
aço inox com cabo
emborrachado
antiderrapante,
trava em metal e
furo no cabo para
argola. Acompanha
bainha em couro
com acabamento em
costura lateral, aba
traseira para cintos
e fechamento com
lingueta e botão de
pressão. Disponível
também sem bainha.



Mochila em polyester para notebook 15", compartimento externo com zíper, um bolso interno e três bolsos externos; Um deles com divisória em tela elástica. Também conta com costas acolchoadas e alças ajustáveis, dois detalhes frontais cromados para saída de ar e orifício superior para saída de fones de ouvido.



Mochila confeccionada em polyester, possui um compartimento interno para notebook 15", alça de mão, dois bolsos externos nas laterais em tela elástica e um frontal com zíper. Também conta com alças ajustáveis para as costas e zíper com duplo cursor na abertura principal.



VIAGEM

Mochila preta confeccionada em Poliéster 600D
Conta com um bolso frontal, dois bolsos laterais em tela elástica e alças ajustáveis.
Possui ainda alça de mão e zíper com duplo cursor na abertura principal.
Capacidade: 20 litros



Mochila azul em Poliéster 600D/1680D com alças para as costas, alça para as mãos, compartimento para notebook de até 15", 3 bolsos externos com zíper e 2 bolsos externos em tela.
Utilidade do Produto: Uma mochila ideal para quem precisa de conforto, praticidade e organização no trabalho, nas viagens e no dia a dia.

■ Preto
■ Azul



Bolsa Térmica preta em Polyester 600D, 300D e PEVA. Conta com alças de mão, tampa com zíper duplo cursor e bolso frontal com zíper. Tempo de Conservação aproximado: Frio 10 horas / Quente 3 horas.



Mochila preta em Poliéster 600D/1680D com alças para as costas, alça para as mãos, compartimento para notebook de até 15", 3 bolsos externos com zíper e 2 bolsos externos em tela.



Preto
Azul



CHURRASCO

Kit para Churrasco, Petisco e Cerveja com tábua três furos e duas espátulas em Bambu; faca 7" e garfo em Bambu/Inox; dois ramequins em Porcelana; quatro taças de cerveja em Vidro. Como cortesia, na faca 7" fazemos uma gravação com os cortes do boi.



Conjunto para Churrasco / Cerveja / Whisky Conta com tábua para churrasco com sulco em Bambu; faca 8" e garfo em Bambu/Inox; caneca para cerveja e copo para whiky em Vidro; avental preto em Brim. Estão acomodados em uma caixa para presentear.



Kit para churrasco e cozinha. Conta com tábua para cozinha, tábua para churrasco; faca 8", faca 7", faca 7" para frios, faca 7" para pão, cutelo 6", faca 5" para desossar, faca 4" para frutas, faca 3" para legumes, chaira e garfo em Bambu/Inox em uma caixa para presentear. Como cortesia, na faca 8" fazemos uma gravação com os cortes do boi.



Kit para churrasco e petisco. Acompanha tábua com três furos e duas espátulas em Bambu; faca 7" e garfo em Bambu/Inox; faca em Aço Inox; dois ramequins. Tábua confeccionada com tripla camada invertida, para dar maior durabilidade e não deformar com o passar do tempo. Rebites em Aço Inox 304, um dos mais resistentes à ferrugem e corrosão.



CHURRASCO

Kit para Churrasco em Bambu/Aço Inox com avental e tábua em Bambu com sulco, faca 8", chaira, garfo em Bambu/Inox, pegador 30cm em Bambu e avental com bolso em Brim preto. Como cortesia, na faca 8" fazemos uma gravação com os cortes do boi.



Conjunto para Churrasco em Bambu/Aço Inox. Acompanha tábua em Bambu com sulco, faca 7", faca 5" para desossar e garfo em Bambu/Inox. Acomodados em uma linda caixa para presente. Como cortesia, na faca 7" fazemos uma gravação com os cortes do boi.

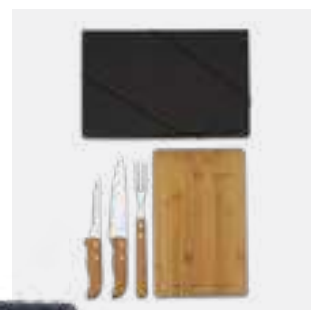

Kit para churrasco. Conta com faca 8", garfo 4 dentes e garfo trinchante em Bambu/Inox; avental em Brim. Faca e garfo trinchante em Aço Forjado AISI420.



Kit contendo tábua com três furos em Bambu; faca 8" e garfo em Bambu/Inox; dois copos de cerveja, dois copos de whisky e dois copinhos de dose em Vidro; caixa para truco com marcador de tentos e jogos em MDF; jogo de cartas. Como cortesia, na faca 8" fazemos uma gravação com os cortes do boi.

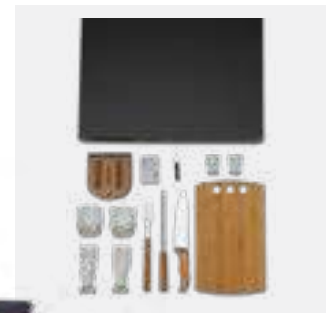

CHURRASCO

Kit para churrasco. Conta com tábua em bambu; faca 8" e garfo em aço inox / bambu. Tábua confeccionada com tripla camada invertida, para dar maior durabilidade e não deformar com o passar do tempo. Rebites em Aço Inox 304, um dos mais resistentes à ferrugem e corrosão.



Kit para churrasco. Conta com tábua em Bambu; faca 8" e garfo 4 dentes em Bambu/Inox. Tábua confeccionada com tripla camada invertida, para dar maior durabilidade e não deformar com o passar do tempo. Rebites em Aço Inox 304, um dos mais resistentes à ferrugem e corrosão.



Conjunto para Churrasco em Bambu / Aço Inox. Conta com tábua em Bambu; faca 8" e garfo em Bambu/Inox. Laminas forjadas Aço AISI420.



Conjunto composto por uma tábua retangular em bambu com sulco, uma faca 7" e um garfo trinchante, ambos com cabo em madeira e lâmina em aço inox com rebites resistentes. Produto ecológico e ideal para empresas ou ações que buscam transmitir mensagens relacionadas à sustentabilidade.



CHURRASCO

Garfo 4 dentes em
Inox / Bambu.



Conjunto composto
por quatro copos
em vidro do tipo
Lager de 200ml,
perfeitamente
acomodados em
uma caixa kraft com
tampa. Ideal para
chopes ou cervejas
do tipo Pilsen.



Conjunto contendo
duas caneca de
vidro para chopp
ou cerveja com
capacidade de 340
ml cada.



Kit de Faca 8" em Bambu/Aço Inox, chaira e garfo em Bambu/Inox. Utilizamos o Bambu, por ser uma matéria prima ecológica, autossustentável e com alta resistência. Além de versátil, o Bambu é 30% mais leve que as madeiras de lei. Sua utilização não agride o meio ambiente, pois, quando ceifado rebrota em pouco tempo.



Conjunto composto por uma faca 7" com a gravação dos cortes do boi na lâmina e um garfo trinchante, ambos com cabos em madeira e lâminas em aço inox com rebites resistentes; Estão organizados em uma caixa kraft para presente.



Conjunto Barbecue em Bambu/Aço Inox com cabo longo. Acompanha faca para Churrasco, pegador para Churrasco, espátula para Churrasco e garfo para Churrasco em Bambu/Inox. Todas as peças têm o cabo longo, especialmente para facilitar o preparo do seu Churrasco.



CHURRASCO

Caneca de Vidro para Chopp ou cerveja.
Capacidade: 340 ml
Utilidade do Produto: Ideal para brindar os melhores momentos.



Jogo com dois copos em vidro.
Capacidade: 300ml cada.



Jogo com 2 Copos de Vidro para Cerveja/ Drinks.
Capacidade: 400ml cada Utilidade do Produto: Ideal para brindar os melhores momentos.



Kit para Queijo e Vinho com tábua para queijo e petiscos, duas facas, sendo uma com ponta e outra reta, garfo e espátula em Bambu/Inox; duas taças para vinho em Vidro; abridor e tampão em Metal; espaço para garrafa com palha. Estão perfeitamente acomodados em uma caixa para presentear.



Kit para Queijo e Vinho Conta com tábua para queijo/ petisco; duas facas, sendo, uma com ponta e outra reta, garfo e espátula em Bambu/Inox; duas taças para vinho em Vidro; abridor em Metal. Estão perfeitamente acomodados em uma caixa para presentear.



Kit para Queijo e Vinho Conta com tábua redonda para queijo/petisco e 4 espetinhos em Bambu; duas taças para vinho em Vidro; abridor em Metal. Estão perfeitamente acomodados em uma caixa para presentear.



Conjunto para queijo em Bambu / Inox. Acompanha tábua e cepo em Bambu; garfo, faca sem ponta, faca com ponta e faca quadrada em Aço Inox 2CR13.



Kit caipirinha com tábua em Bambu, faca para frutas 4" em Inox/Bambu, pilão, colher de 18cm e base para a tábua em Bambu e coqueteleira de 350ml em Aço Inox. Acomodados em uma linda caixa para presente.



Kit para caipirinha. Conta com tábua e socador em bambu; copo de vidro 350ml; faca para frutas de 4" em aço inox. Produto ecológico e ideal para transmitir mensagens relacionadas à sustentabilidade e à cultura nacional.



RECEBER EM CASA

Kit em Inox e bambu com uma coqueteleira de 350ml em aço inox escovado com acabamento externo brilhante, faca para frutas de 4", colher em bambu de 18cm, coador em aço inox, abridor saca-rolhas modelo sommelier de alavanca simples, pegador de gelos, socador/pilão e uma tábua pequena.



Kit para whisky e jogos. Conta com dois copos para whisky, baralho, caneta esferográfica e bloco para anotações. Estão perfeitamente acomodados em uma caixa para presentear.



Jogo com 4 Copos de Vidro para Cerveja/ Drinks. Capacidade: 400ml cada Utilidade do Produto: Ideal para brindar os melhores momentos.



Kit para Queijo e Cerveja Conta com tábua para queijo/petisco; faca para frios em Metal; dois copos para cerveja em Vidro. Estão acomodados em uma caixa para presentear.



RECEBER EM CASA

Kit para Petisco com petisqueira em formato de coração e duas espátulas 14cm em Bambu; dois ramekins, um pequeno e um mini em Porcelana. Estão perfeitamente acomodados em uma caixa para presentear.



Kit para cafézinho. 4 xícaras com pires em Porcelana; 4 colheres em inox.



Conjunto de facas em Aço Inox para queijos. Acompanha garfo, faca sem ponta, faca com ponta e faca quadrada em Aço Inox 2CR13.



Petisqueira em Bambu com formato de trevo de 4 folhas. Conta com 4 divisões.



Kit para queijo. Conta com tábua redonda em bambu; três facas e garfo para queijos. Tábua confeccionada com tripla camada invertida, para dar maior durabilidade e não deformar com o passar do tempo.



RECEBER EM CASA

Conjunto para Pizza em Bambu/Aço Inox. Acompanha tábua e espátula em Bambu; quatro facas de mesa, quatro garfos de mesa e cortador de Pizza em Bambu/Inox. Embalagem ideal para presentear.



Kit para queijo. Conta com tábua redonda e suporte em bambu; três facas e garfo para queijos. Tábua confeccionada com tripla camada invertida, para dar maior durabilidade e não deformar com o passar do tempo.



Conjunto para queijo em Bambu / Inox. Acompanha tábua em Bambu; garfo, faca sem ponta, faca com ponta e faca quadrada em Aço Inox 2CR13. Produto ecológico e ideal para empresas ou ações que buscam transmitir mensagens relacionadas à sustentabilidade.



Conjunto para Queijo em Bambu / Inox. Conta com tábua em Bambu; faca com ponta e garfo para queijo em Bambu / Inox. Tábua confeccionada com tripla camada invertida, para dar maior durabilidade e não deformar com o passar do tempo.

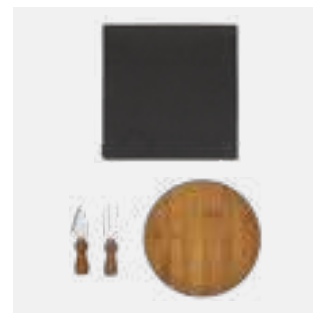

Conjunto para Pizza em Bambu/Aço Inox. Acompanha tábua e espátula em Bambu e cortador de Pizza em Bambu/Inox. Embalagem ideal para presentear.



Conjunto para Pizza em Bambu/Aço Inox. Acompanha tábua em Bambu; cortador de Pizza em Bambu/Inox.



RECEBER EM CASA

Petisqueira giratória em Bambu. Conta com seis divisórias, com placas removíveis, e um bowl para molhos e patê



Conjunto para petiscos e patês em Bambu/Fibra de Bambu. Acompanha dois potes em Fibra de Bambu, base e duas espátulas 14cm em Bambu. Utilizamos o Bambu, por ser uma matéria prima ecológica, autossustentável e com alta resistência. Além de versátil, o Bambu é 30% mais leve que as madeiras de lei.



Conjunto para petisco em Bambu/Fibra de Bambu. Acompanha cinco potes em Fibra de Bambu; quatro garfos em Aço Inox com ponta em formato de azeitona; base em Bambu com alças em Aço Inoxidável.



Caixa para Chás em Bambu/Poliestireno. Possui 6 divisões e tampa com visor em Poliestireno. Não acompanha chás.



Composto por cinco acessórios para vinho em metal e inox, sendo um anel corta-gotas, um funil direcionador com tampa e tampão, ambos com detalhes emborrachados para melhor fixação na garrafa, um termômetro e um abridor saca-rolhas modelo sommelier de alavanca simples com três funções acomodados em um estojo em bambu.



Abridor saca-rolhas em aço inox escovado. Conta com agulha espiral saca-rolhas, uma lâmina canivete de 1" com serra para cortar lacres e abridor de garrafas com duas bases de apoio.



COZINHAR E SERVIR

Avental em brim preto. Conta com um bolso frontal, tiras para amarrar na cintura e pescoço com regulagem de altura.



Conjunto composto por uma faca 7" com a gravação dos cortes do boi na lâmina, um garfo trinchante, ambos com cabos em madeira e lâminas em aço inox com rebites resistentes e uma colher em bambu 30cm; Estão organizados em uma caixa kraft para presente.



Faca de 7 polegadas em aço inox com cabo em bambu, conta com design anatômico e patenteado, possui lâmina em aço inox e dois rebites em aço inox 304, um dos mais resistentes à ferrugem e corrosão. Produto ecológico e ideal para empresas ou ações que buscam transmitir mensagens relacionadas à sustentabilidade.



Conjunto para cozinha em Bambu / Inox. Acompanha tábua com 3 furos e cepo em Bambu; faca 7", faca para pão 7", faca para frutas 4" e faca para legumes 3".



Conjunto para Cozinha/Pão em Bambu/Aço Inox. Acompanha tábua com sulco para aparar migalhas e colher 30cm em Bambu; faca 7", faca 7" para pão, faca 3" para legumes em Aço Inox/Bambu. Acomodados em uma linda caixa para presente. Tábua confeccionada com tripla camada invertida, para dar maior durabilidade.



COZINHAR E SERVIR

Tábua para Cozinha em Bambu em formato de coração. Confeccionada com tripla camada invertida, para dar maior durabilidade e não deformar com o passar do tempo.



Tábua para Cozinha em Bambu em formato de porco. Confeccionada com tripla camada invertida, para dar maior durabilidade e não deformar com o passar do tempo.



Tábua para churrasco / cozinha em bambu. Conta com sulco ao redor da tábua. Confeccionada com tripla camada invertida, para dar maior durabilidade e não deformar com o passar do tempo.



Kit para Churrasco. Acompanha tábua em Bambu; faca 7", faca santoku e espátula multiuso em Bambu/Inox; avental em Brim. Tábua confeccionada com tripla camada invertida, para dar maior durabilidade e não deformar com o passar do tempo. Rebites em Aço Inox 304, um dos mais resistentes à ferrugem e corrosão.



Kit para cozinha Acompanha tábua e colher 30cm em Bambu; espátula multiuso em Bambu/Inox. Acomodados em uma linda caixa para presente. Tábua confeccionada com tripla camada invertida, para dar maior durabilidade e não deformar com o passar do tempo. Rebites em Aço Inox 304, um dos mais resistentes à ferrugem e corrosão.



COZINHAR E SERVIR

Kit Matinal Conta com duas canecas em Cerâmica; duas tigelas e pote em Vidro; duas colheres em Bambu. Capacidade das canecas: 270ml cada.



Conjunto para Patê / Geléia. Conta com 2 potes de vidro com tampa; 2 espátulas em Bambu.



Tábua para churrasco / cozinha em bambu. Conta com sulco ao redor da tábua. Confeccionada com tripla camada invertida, para dar maior durabilidade e não deformar com o passar do tempo.



Moedor de sal grosso e pimenta em bambu e aço inox. Conta com haste interna em alumínio e mecanismo em cerâmica.



Moedor de sal grosso e pimenta em bambu. Conta com haste interna em alumínio e mecanismo em cerâmica.



COZINHAR E SERVIR

Bandeja para servir em Bambu. Conta com alças para melhor uso. (imagem ilustrativa, não acompanha outros produtos)



Conjunto para salada em bambu com pegador de 30cm. Utilizamos o Bambu, por ser uma matéria prima ecológica, autossustentável e com alta resistência. Além de versátil, o Bambu é 30% mais leve que as madeiras de lei. Sua utilização não agride o meio ambiente, pois, quando ceifado rebrota em pouco tempo.



Porta-guardanapos em Bambu. Conta com uma esfera em metal cromado, para segurar os guardanapos.



Conjunto de Utensílios de 30cm em Bambu, composto por colher, colher perfurada, espátula perfurada, espátula reta e porta utensílios.



Colher em bambu. Conta com 30cm de comprimento, cabo com furo para pendurá-la em ganchos e facilitar seu uso e caixa para presentear.



Espátula multiuso em Bambu / Inox. Conta um leve fio de corte.



COZINHAR E SERVIR

Porta-condimentos em bambu / vidro. Conta com seis recipientes com capacidade para 100ml em vidro; base giratória em bambu.



Amassador de temperos em Bambu. Conta com base e socador.



Farinheira em Bambu. Conta com cumbuca, tampa e colher.





☎ (11) 4608-0713

☎ (11) 4608-0318

✉ atendimento@sillopromocional.com.br

Visite nosso site

 Siga no
Instagram



@sillopromocional

 Curta nossa
Fan Page



@sillopromocional

 Fale com um
Especialista



11 4608-0318



sillopromocional.com.br